

NPN Silicon Transistors

SMBT 6428
SMBT 6429

- For AF input stages and driver applications
- High current gain
- Low collector-emitter saturation voltage

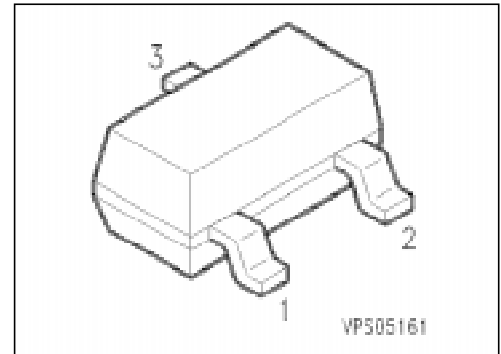

Type	Marking	Ordering Code (tape and reel)	Pin Configuration			Package ¹⁾
			1	2	3	
SMBT 6428	s1K	Q68000-A8321	B	E	C	SOT-23
SMBT 6429	s1L	Q68000-A8322				

Maximum Ratings

Parameter	Symbol	Values		Unit
		SMBT 6428	SMBT 6429	
Collector-emitter voltage	V_{CE0}	50	45	V
Collector-base voltage	V_{CB0}	60	55	
Emitter-base voltage	V_{EB0}	6		
Collector current	I_C	200		mA
Total power dissipation, $T_s = 71\text{ °C}$	P_{tot}	330		mW
Junction temperature	T_j	150		°C
Storage temperature range	T_{stg}	- 65 ... + 150		

Thermal Resistance

Junction - ambient ²⁾	$R_{th\ JA}$	≤ 310	K/W
Junction - soldering point	$R_{th\ JS}$	≤ 240	

¹⁾ For detailed information see chapter Package Outlines.

²⁾ Package mounted on epoxy pcb 40 mm × 40 mm × 1.5 mm/6 cm² Cu.

Electrical Characteristics

at $T_A = 25\text{ °C}$, unless otherwise specified.

Parameter	Symbol	Values			Unit	
		min.	typ.	max.		
DC characteristics						
Collector-emitter breakdown voltage $I_C = 1\text{ mA}$	$V_{(BR)CE0}$	50	–	–	V	
SMBT 6428		45	–	–		
SMBT 6429						
Collector-base breakdown voltage $I_C = 10\text{ }\mu\text{A}$	$V_{(BR)CB0}$	60	–	–		
SMBT 6428		55	–	–		
SMBT 6429						
Emitter-base breakdown voltage $I_E = 1\text{ }\mu\text{A}$	$V_{(BR)EB0}$	6	–	–		
Collector-base cutoff current $V_{CB} = 30\text{ V}, I_E = 0$ $V_{CB} = 30\text{ V}, I_E = 0, T_A = 150\text{ °C}$	I_{CB0}	–	–	10	nA	
		–	–	10	μA	
Collector cutoff current $V_{CE} = 30\text{ V}, I_B = 0$	I_{CE0}	–	–	100	nA	
Emitter-base cutoff current $V_{EB} = 5\text{ V}, I_C = 0$	I_{EB0}	–	–	10		
DC current gain $I_C = 10\text{ }\mu\text{A}, V_{CE} = 5\text{ V}$	h_{FE}	250	–	–	–	
SMBT 6428						
SMBT 6429			500	–		–
$I_C = 100\text{ }\mu\text{A}, V_{CE} = 5\text{ V}$			250	–		650
SMBT 6428			500	–		1250
SMBT 6429						
$I_C = 1\text{ mA}, V_{CE} = 5\text{ V}$			250	–		–
SMBT 6428			500	–		–
SMBT 6429						
$I_C = 10\text{ mA}, V_{CE} = 5\text{ V}$			250	–		–
SMBT 6428			500	–		–
SMBT 6429						
Collector-emitter saturation voltage ¹⁾ $I_C = 10\text{ mA}, I_B = 0.5\text{ mA}$ $I_C = 100\text{ mA}, I_B = 5\text{ mA}$	V_{CEsat}	–	–	0.2	V	
		–	–	0.6		
Base-emitter voltage $I_C = 1\text{ mA}, V_{CE} = 5\text{ V}$	$V_{BE(on)}$	0.56	–	0.66		

¹⁾ Pulse test conditions: $t \leq 300\text{ }\mu\text{s}$, $D \leq 2\text{ %}$.

Electrical Characteristics

at $T_A = 25\text{ }^\circ\text{C}$, unless otherwise specified.

Parameter	Symbol	Values			Unit
		min.	typ.	max.	

AC characteristics

Transition frequency $I_C = 5\text{ mA}$, $V_{CE} = 5\text{ V}$, $f = 100\text{ MHz}$	f_T	100	–	700	MHz
Output capacitance $V_{CB} = 10\text{ V}$, $f = 1\text{ MHz}$	C_{obo}	–	–	3	pF
Input capacitance $V_{EB} = 0.5\text{ V}$, $f = 1\text{ MHz}$	C_{ibo}	–	–	15	

Total power dissipation $P_{tot} = f(T_A^*; T_S)$

* Package mounted on epoxy

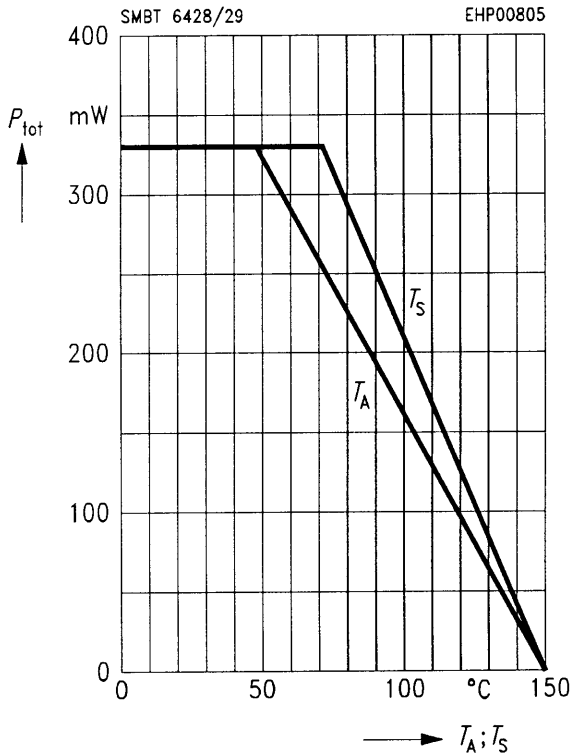

Collector-base capacitance $C_{CB0} = f(V_{CB0})$

Emitter-base capacitance $C_{EB0} = f(V_{EB0})$

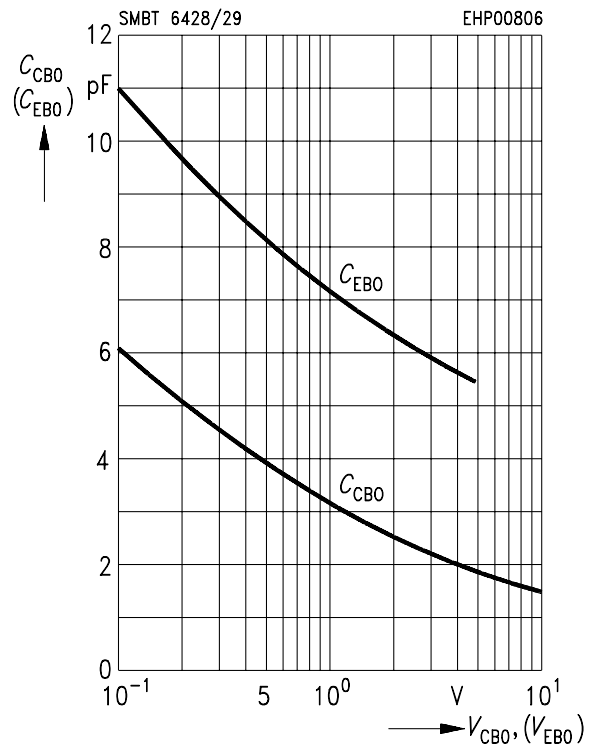

Permissible pulse load $P_{tot max} / P_{tot DC} = f(t_p)$

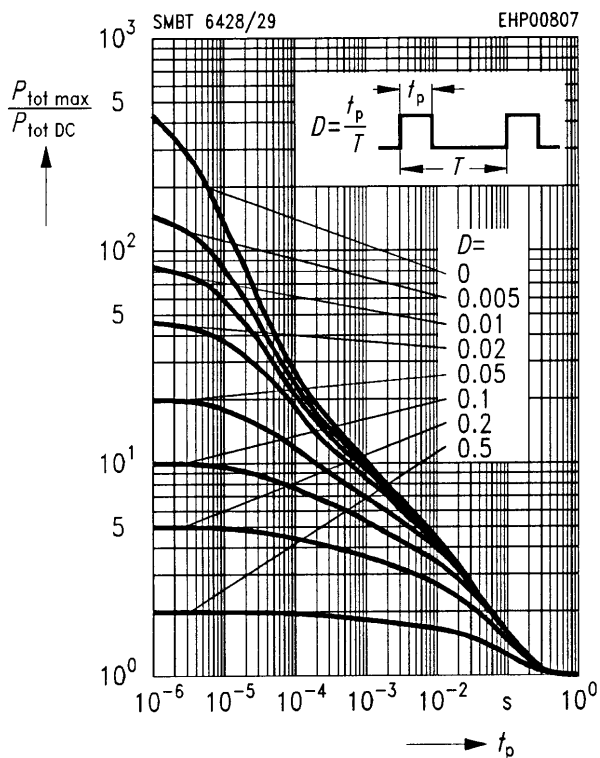

Transition frequency $f_T = f(I_C)$

$V_{CE} = 5 V$

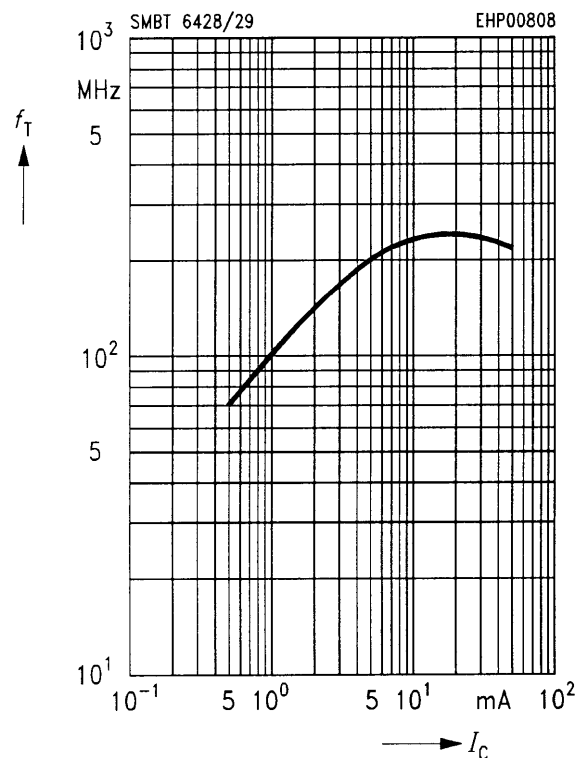

Base-emitter saturation voltage

$I_C = f(V_{BEsat}), h_{FE} = 40$

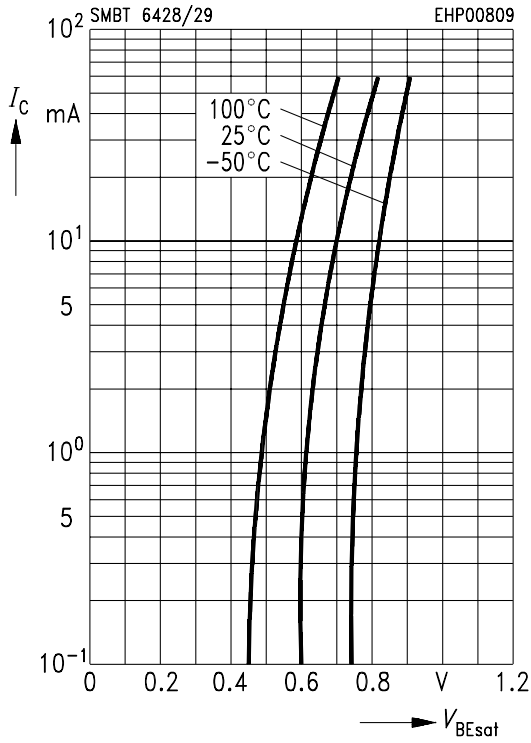

Collector-emitter saturation voltage

$I_C = f(V_{CEsat}), h_{FE} = 40$

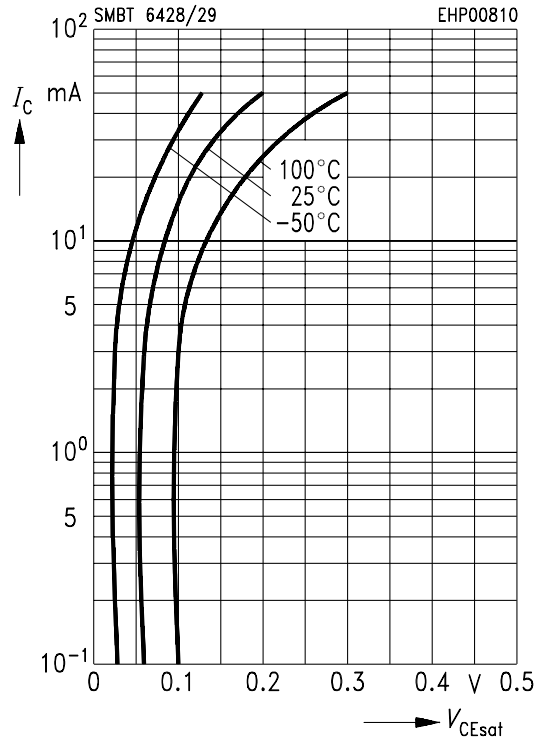

Collector current $I_C = f(V_{BE})$

$V_{CE} = 1 V$

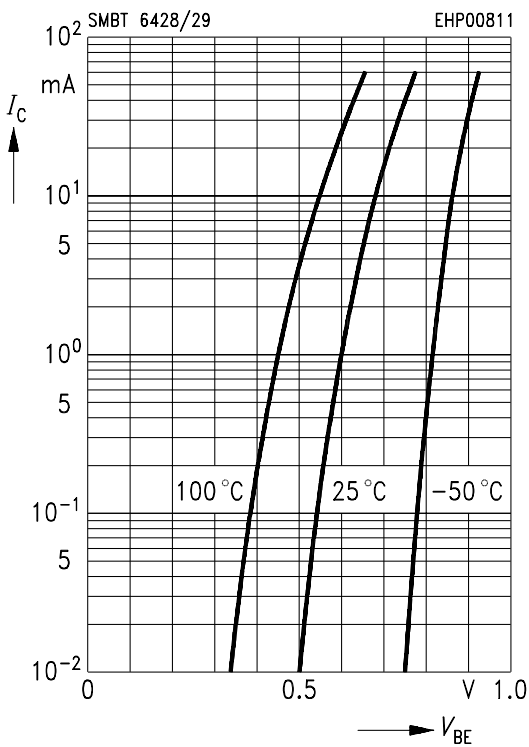

DC current gain $h_{FE} = f(I_C)$

$V_{CE} = 1 V$

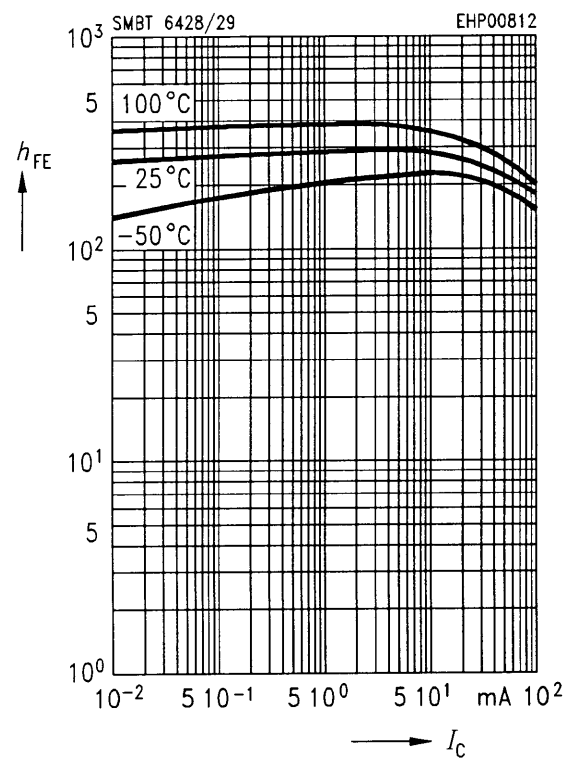

Collector cutoff current $I_{CB0} = f(T_A)$

$V_{CB} = 30 \text{ V}$

