

NPN Silicon Darlington Transistors

SMBTA 13
SMBTA 14

- High DC current gain
- High collector current
- Collector-emitter saturation voltage

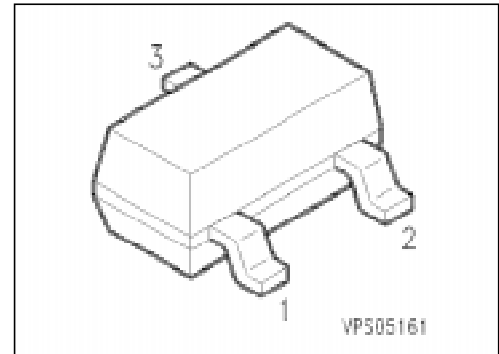

Type	Marking	Ordering Code (tape and reel)	Pin Configuration			Package ¹⁾
			1	2	3	
SMBTA 13 SMBTA 14	s1M s1N	Q68000-A6475 Q68000-A6476	B	E	C	SOT-23

Maximum Ratings

Parameter	Symbol	Values	Unit
Collector-emitter voltage	V_{CE0}	30	V
Collector-base voltage	V_{CB0}	30	
Emitter-base voltage	V_{EB0}	10	
Collector current	I_C	300	mA
Peak collector current	I_{CM}	500	
Base current	I_B	100	
Peak base current	I_{BM}	200	
Total power dissipation, $T_s = 81\text{ °C}$	P_{tot}	330	mW
Junction temperature	T_j	150	°C
Storage temperature range	T_{stg}	- 65 ... + 150	

Thermal Resistance

Junction - ambient ²⁾	$R_{th\ JA}$	≤ 280	K/W
Junction - soldering point	$R_{th\ JS}$	≤ 210	

¹⁾ For detailed information see chapter Package Outlines.

²⁾ Package mounted on epoxy pcb 40 mm × 40 mm × 1.5 mm/6 cm² Cu.

Electrical Characteristics

at $T_A = 25\text{ °C}$, unless otherwise specified.

Parameter	Symbol	Values			Unit
		min.	typ.	max.	

DC characteristics

Collector-emitter breakdown voltage $I_C = 10\text{ }\mu\text{A}$	$V_{(BR)CE0}$	30	–	–	V
Collector-base breakdown voltage $I_C = 10\text{ }\mu\text{A}$	$V_{(BR)CB0}$	30	–	–	
Emitter-base breakdown voltage $I_E = 10\text{ }\mu\text{A}$	$V_{(BR)EB0}$	10	–	–	
Collector-base cutoff current $V_{CB} = 30\text{ V}$	I_{CB0}	–	–	100	nA
Emitter-base cutoff current $V_{EB} = 10\text{ V}$	I_{EB0}	–	–	100	
DC current gain $I_C = 10\text{ mA}$, $V_{CE} = 5\text{ V}^{1)}$	h_{FE}	SMBTA 13	5000	–	–
		SMBTA 14	10000	–	–
$I_C = 100\text{ mA}$, $V_{CE} = 5\text{ V}^{1)}$		SMBTA 13	10000	–	–
		SMBTA 14	20000	–	–
Collector-emitter saturation voltage ¹⁾ $I_C = 100\text{ mA}$, $I_B = 0.1\text{ mA}$	V_{CEsat}	–	–	1.5	V
Base-emitter saturation voltage ¹⁾ $I_C = 100\text{ mA}$, $I_B = 0.1\text{ mA}$	V_{BEsat}	–	–	2	

AC characteristics

Transition frequency $I_C = 50\text{ mA}$, $V_{CE} = 5\text{ V}$, $f = 20\text{ MHz}$	f_T	125	–	–	MHz
--------------------------------------------------------------------------------------------	-------	-----	---	---	-----

¹⁾ Pulse test conditions: $t \leq 300\text{ }\mu\text{s}$, $D = 2\text{ %}$.

Total power dissipation $P_{tot} = f(T_A^*; T_S)$

* Package mounted on epoxy

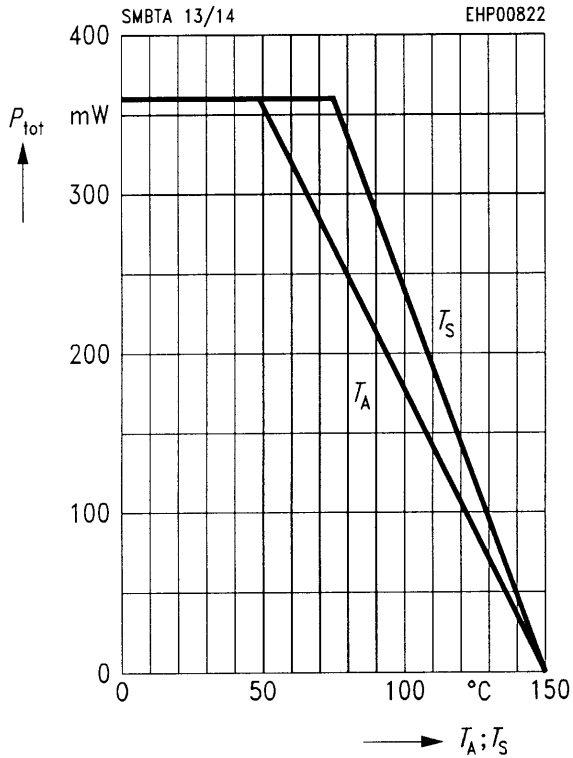

Capacitance $C_{CB0} = f(V_{CB0})$

$C_{EB0} = f(V_{EB0})$
 $f = 1 \text{ MHz}$

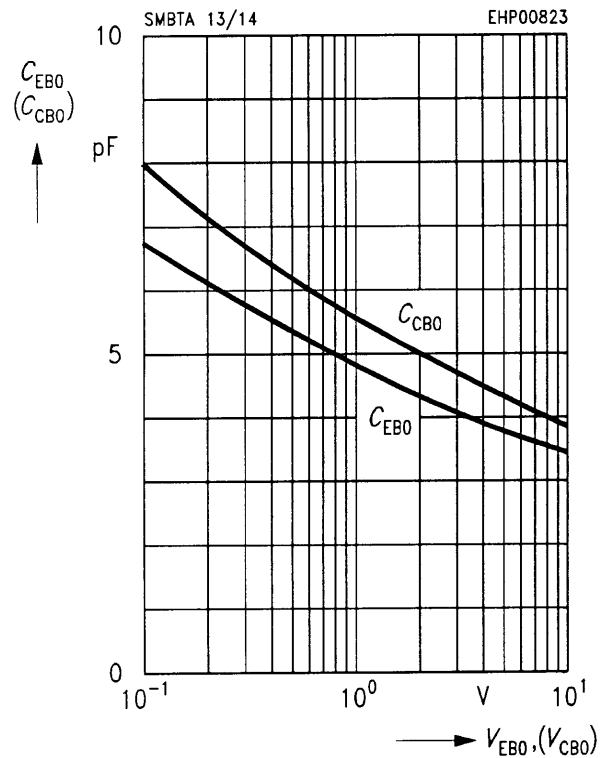

Permissible pulse load $P_{tot \text{ max}} / P_{tot \text{ DC}} = f(t_p)$

Transition frequency $f_T = f(I_C)$

$V_{CE} = 5 \text{ V}, f = 20 \text{ MHz}$

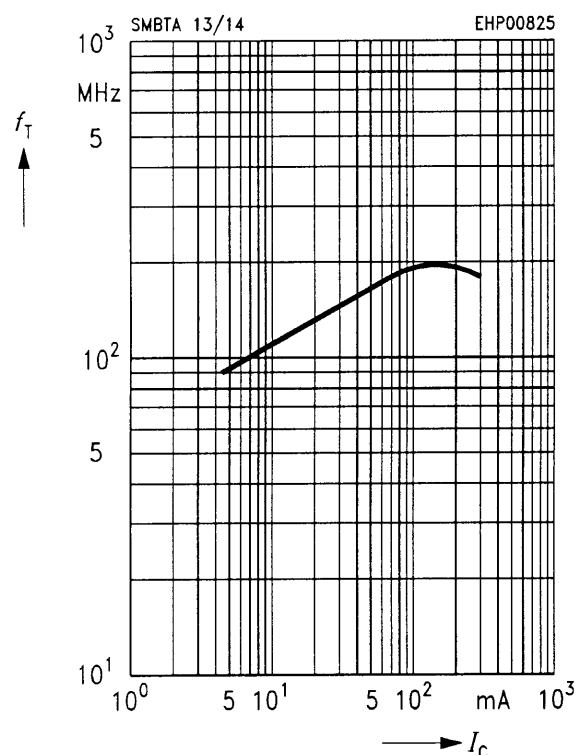
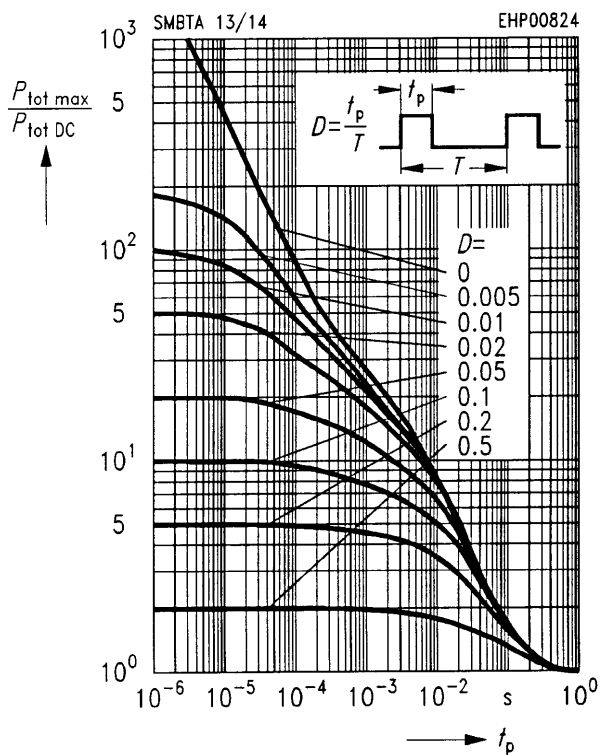

Base-emitter saturation voltage

$I_C = f(V_{BE\ sat})$
 $h_{FE} = 1000$

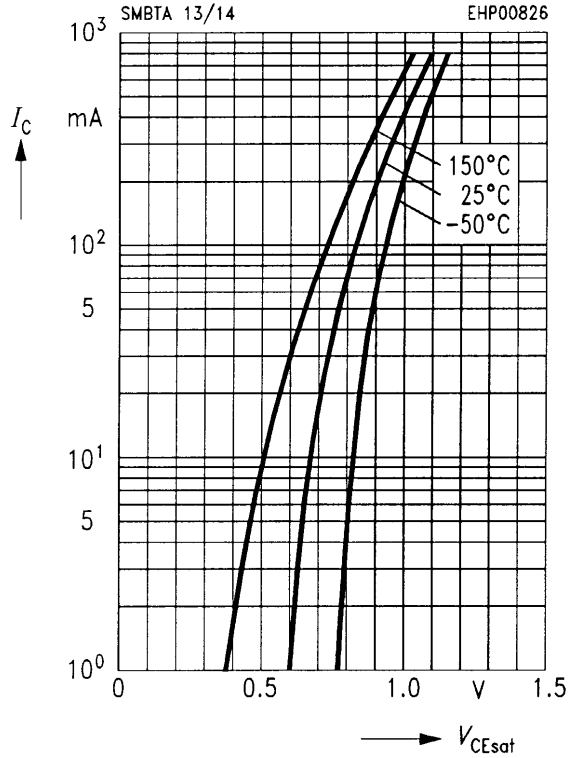

Collector-emitter saturation voltage

$I_C = f(V_{CE\ sat})$
 $h_{FE} = 1000$

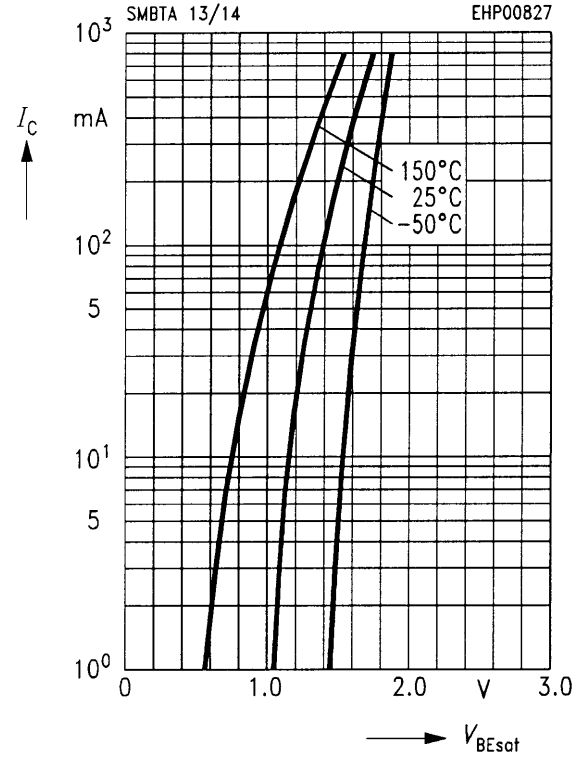

Collector cutoff current $I_{CB0} = f(T_A)$

$V_{CB} = 30\ V$

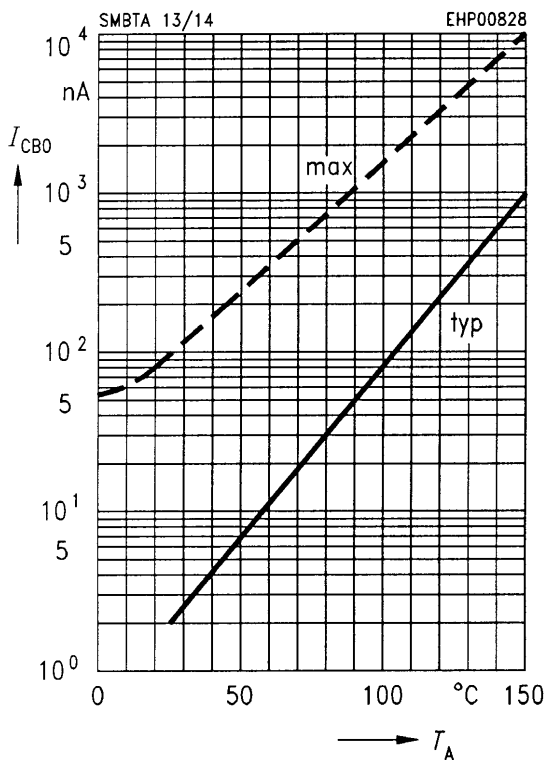

DC current gain $h_{FE} = f(I_C)$

$V_{CE} = 5\ V$

