

## Ge-Avalanche Photodiode in TO Package with Integrated Optics

SRD 00512Z

- Designed for application in fiber-optic communication systems
- Sensitive receiver for the 2<sup>nd</sup> optical window (1300 nm)
- High gain-bandwidth product
- Suitable for bit rates up to 1.2 Gbit/s and long-haul transmission
- Planar structure
- Small radiant sensitive area
- Low multiplied dark current
- High spectral sensitivity by built-in optics
- Hermetically sealed 3-pin metal case

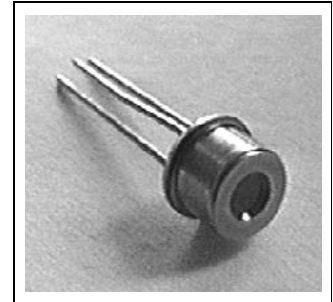

Type	Ordering Code	Connector/Flange
SRD 00512Z	Q62702-P3042	TO, with optics

### Maximum Ratings

Parameter	Symbol	Values	Unit
Forward current	$I_F$	50	mA
Reverse voltage	$V_R$	*	V
Operating and storage temperature	$T_A$ $T_{stg}$	- 40 ... + 85	°C
Max. radiant power into the opt. port ( $V_R = 5$ V)	$\Phi_{port}$	1	mW
Soldering time (wave / dip soldering), distance between solder point and base plate ( $\geq 2$ mm, 260 °C)	$t_s$	10	s

\* Individual value of  $V_{BR}$  is delivered with each component.

### Characteristics

All optical data refer to an optimally coupled 10/125  $\mu\text{m}$  SM fiber at ambient temperature of 25 °C, unless otherwise defined.

Parameter	Symbol	Values	Unit
Spectral sensitivity $\lambda = 1310 \text{ nm}$ , $M = 1$	$S_\lambda$	0.8 ( $\geq 0.7$ )	A/W
Rise and fall time (10 % – 90 %) $R_L = 50 \Omega$ , $M = 1$ , $\lambda = 1310 \text{ nm}$ , $\Phi_{\text{port}} = 100 \mu\text{W}$	$t_r$ ; $t_f$	0.3 ( $\leq 0.5$ )	ns
Multiplication factor at $V_R = 0.9 V_{\text{BR}}$	$M$	4 ( $\geq 3$ )	
Breakdown voltage $I_R = 100 \mu\text{A}$	$V_{\text{BR}}$	28 ... 40	V
Total capacitance $V_R = 0.9 V_{\text{BR}}$ , $\Phi_{\text{port}} = 0$ , $f = 1 \text{ MHz}$	$C$	$\leq 2$	pF
Dark current $V_R = 10 \text{ V}$ $V_R = 0.9 V_{\text{BR}}$	$I_D$	< 200 < 300	nA nA
Multiplied dark current ( $M = 10$ )	$I_{\text{DM}}$	$\leq 20$	nA

**Rel. Spectral Sensitivity**

$M = 1 (V_R = 10 \text{ V})$

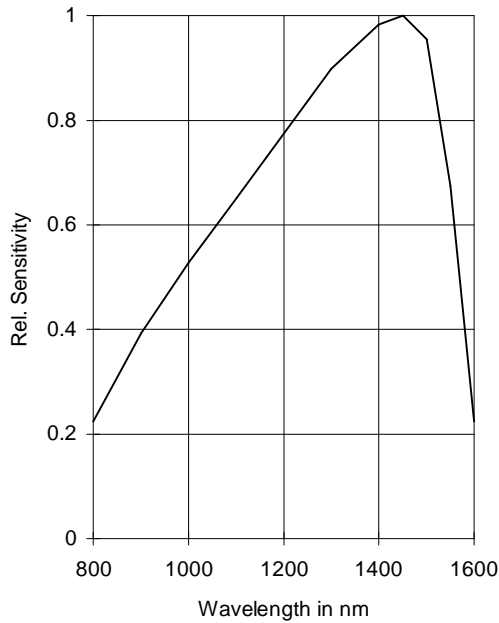

**Dark Current  $I_D = I_D(V_R / V_{BR})$**

**Multiplication Factor  $M = M(V_R / V_{BR})$**

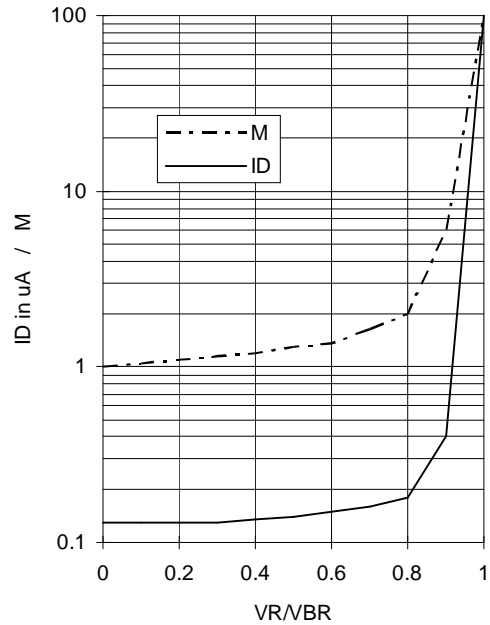

**Frequency Response of Sensitivity**

$S = S(f), \lambda = 1300 \text{ nm}$

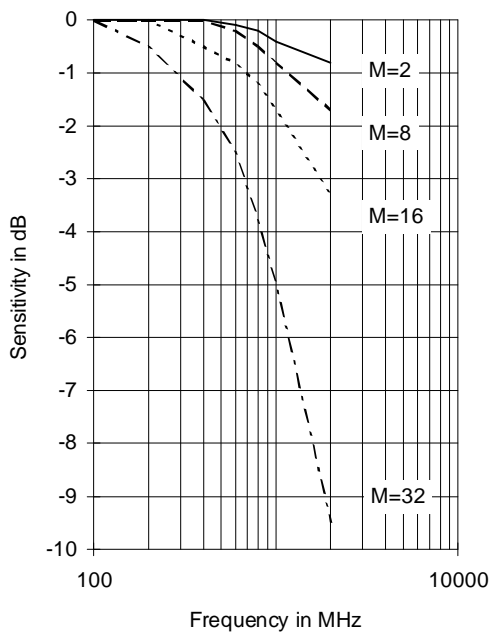

**Temperatur Behaviour of Breakdown Voltage**

$V_{BR} / V_{BR(25^\circ\text{C})}(T_A)$

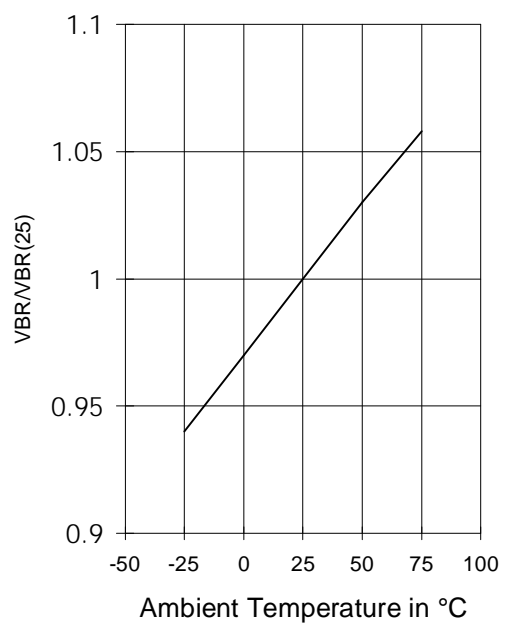

### Temperature Behaviour of Dark Current

$$I_D / I_{D(25^\circ\text{C})}(T_A)$$

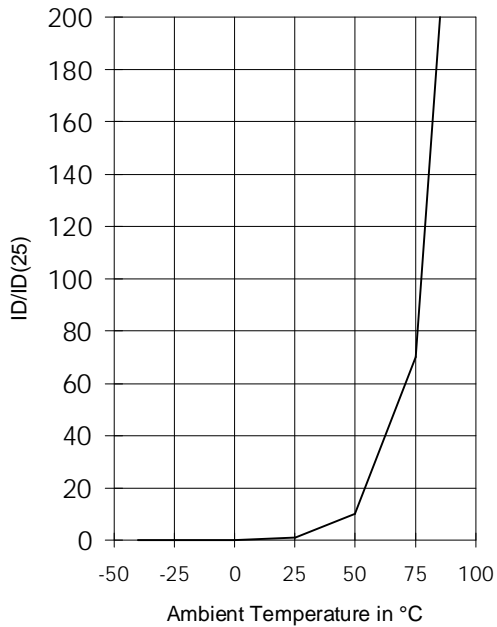

### Sensitivity at different input Powers

$$V_{BR} / V_{BR(25^\circ\text{C})}(T_A)$$

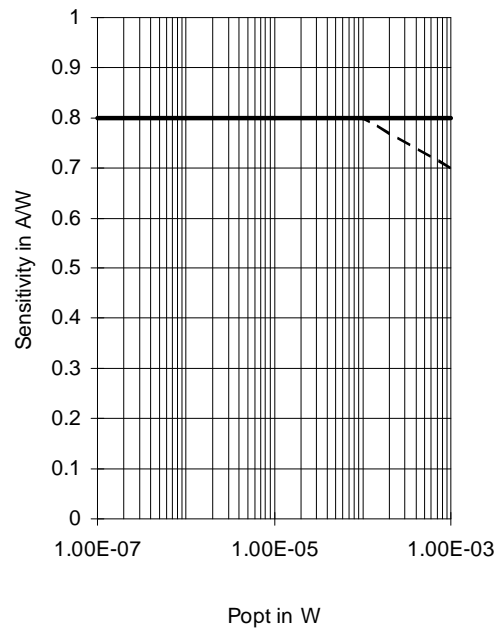

### Package Outlines (Dimensions in mm)

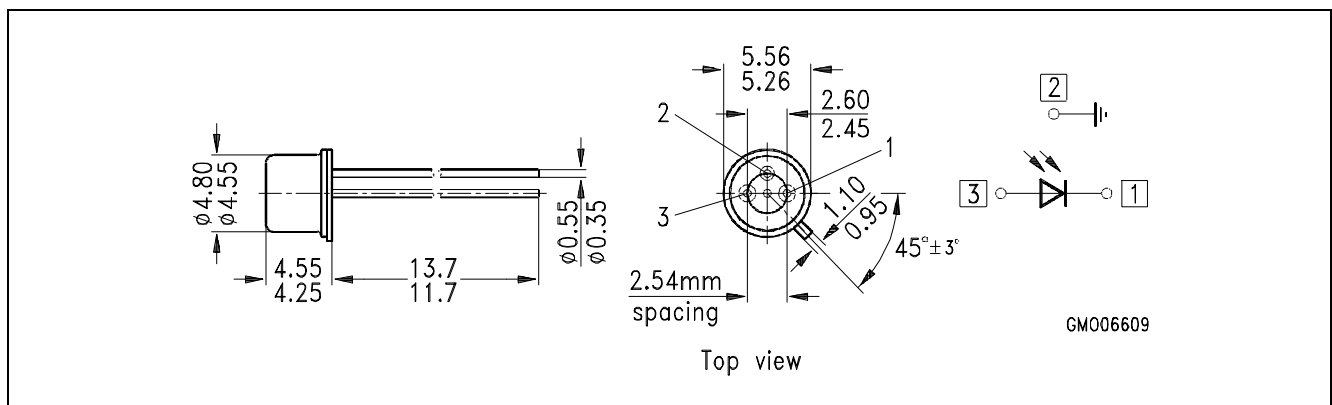

SRD 00512Z