

PNP Silicon Switching Transistor

SXT 3906

- High current gain: 0.1 mA to 100 mA
- Low collector-emitter saturation voltage

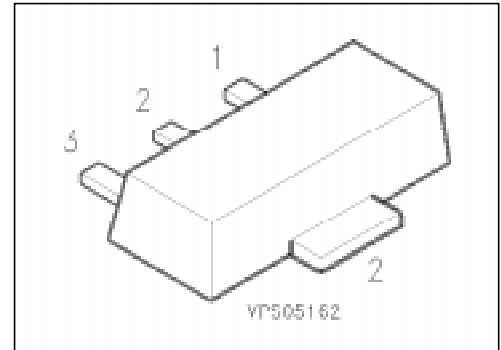

Type	Marking	Ordering Code (tape and reel)	Pin Configuration			Package ¹⁾
			1	2	3	
SXT 3906	2A	Q68000-A8397	B	C	E	SOT-89

Maximum Ratings

Parameter	Symbol	Values	Unit
Collector-emitter voltage	V_{CE0}	40	V
Collector-base voltage	V_{CB0}	40	
Emitter-base voltage	V_{EB0}	5	
Collector current	I_C	200	mA
Total power dissipation, $T_s = 100\text{ °C}$	P_{tot}	1	W
Junction temperature	T_j	150	°C
Storage temperature range	T_{stg}	- 65 ... + 150	

Thermal Resistance

Junction - ambient ²⁾	$R_{th\ JA}$	≤ 120	K/W
Junction - soldering point	$R_{th\ JS}$	≤ 50	

¹⁾ For detailed information see chapter Package Outlines.

²⁾ Package mounted on epoxy pcb 40 mm × 40 mm × 1.5 mm/6 cm² Cu.

Electrical Characteristics

at $T_A = 25\text{ }^\circ\text{C}$, unless otherwise specified.

Parameter	Symbol	Values			Unit
		min.	typ.	max.	

DC characteristics

Collector-emitter breakdown voltage $I_C = 1\text{ mA}$	$V_{(BR)CE0}$	40	–	–	V
Collector-base breakdown voltage $I_C = 10\text{ }\mu\text{A}$	$V_{(BR)CB0}$	40	–	–	
Emitter-base breakdown voltage $I_E = 10\text{ }\mu\text{A}$	$V_{(BR)EB0}$	5	–	–	
Collector-base cutoff current $V_{CB} = 30\text{ V}$	I_{CB0}	–	–	50	nA
Collector-emitter cutoff current $V_{CE} = 30\text{ V}, V_{BE} = -3\text{ V}$	I_{CEV}	–	–	50	
DC current gain $I_C = 100\text{ }\mu\text{A}, V_{CE} = 1\text{ V}$ $I_C = 1\text{ mA}, V_{CE} = 1\text{ V}$ $I_C = 10\text{ mA}, V_{CE} = 1\text{ V}$ $I_C = 50\text{ mA}, V_{CE} = 1\text{ V}$ $I_C = 100\text{ mA}, V_{CE} = 1\text{ V}$	h_{FE}	60 80 100 60 30	– – – – –	– – 300 – –	–
Collector-emitter saturation voltage ¹⁾ $I_C = 10\text{ mA}, I_B = 1\text{ mA}$ $I_C = 50\text{ mA}, I_B = 5\text{ mA}$	V_{CEsat}	– –	– –	0.25 0.4	V
Base-emitter saturation voltage ¹⁾ $I_C = 10\text{ mA}, I_B = 1\text{ mA}$ $I_C = 50\text{ mA}, I_B = 5\text{ mA}$	V_{BEsat}	0.65 –	– –	0.85 0.95	

¹⁾ Pulse test conditions: $t \leq 300\text{ }\mu\text{s}, D \leq 2\%$.

Electrical Characteristics

at $T_A = 25\text{ }^\circ\text{C}$, unless otherwise specified.

Parameter	Symbol	Values			Unit
		min.	typ.	max.	

AC characteristics

Transition frequency $I_C = 10\text{ mA}$, $V_{CE} = 20\text{ V}$, $f = 100\text{ MHz}$	f_t	250	–	–	MHz
Output capacitance $V_{CB} = 5\text{ V}$, $f = 1\text{ MHz}$	C_{obo}	–	–	4.5	pF
Input capacitance $V_{EB} = 0.5\text{ V}$, $f = 1\text{ MHz}$	C_{ibo}	–	–	10	
Input impedance $I_{CE} = 1\text{ mA}$, $V_{CE} = 10\text{ V}$, $f = 1\text{ kHz}$	h_{ie}	2	–	12	k Ω
Voltage feedback ratio $I_C = 1\text{ mA}$, $V_{CE} = 10\text{ V}$, $f = 1\text{ kHz}$	h_{re}	0.1	–	10	10^{-4}
Small-signal current gain $I_C = 1\text{ mA}$, $V_{CE} = 10\text{ V}$, $f = 1\text{ kHz}$	h_{te}	100	–	400	–
Output admittance $I_C = 1\text{ mA}$, $V_{CE} = 10\text{ V}$, $f = 1\text{ kHz}$	h_{oe}	3	–	60	μS
Noise figure $I_C = 0.1\text{ mA}$, $V_{CE} = 5\text{ V}$, $f = 10\text{ Hz to }15\text{ kHz}$ $R_S = 1\text{ k}\Omega$	NF	–	–	4	dB
Switching times $V_{CC} = 3\text{ V}$, $V_{BE} = 0.5\text{ V}$, $I_C = 10\text{ mA}$, $I_{B1} = 1\text{ mA}$	t_d	–	–	35	ns
	t_r	–	–	35	ns
$V_{CC} = 3\text{ V}$, $I_C = 10\text{ mA}$, $I_{B1} = 1\text{ mA}$	t_s	–	–	225	ns
	t_f	–	–	75	ns

Test circuits

Delay and rise time

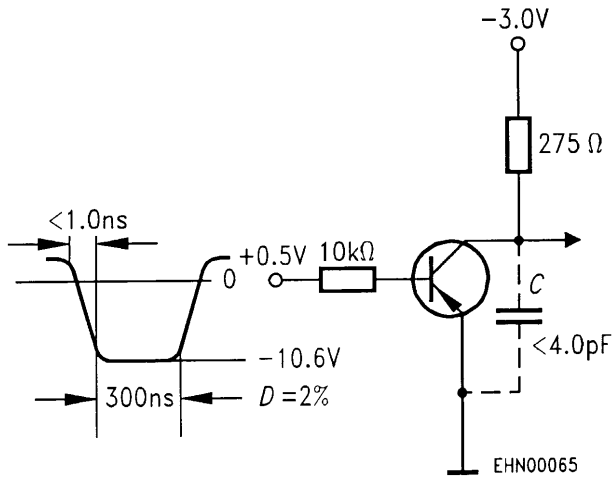

Storage and fall time

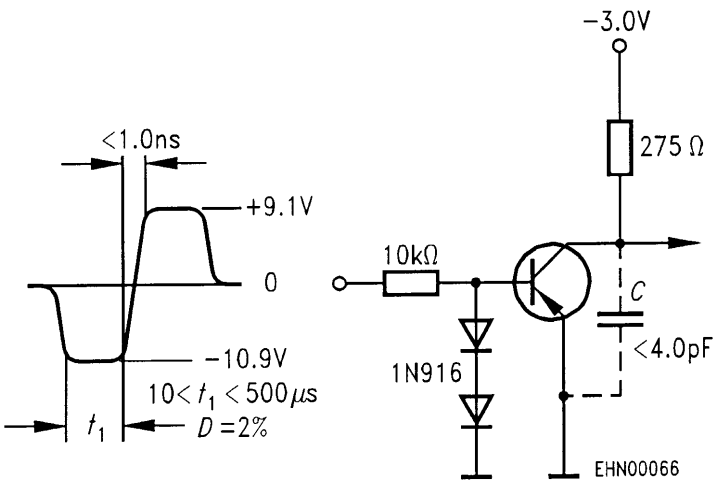

Total power dissipation $P_{tot} = f(T_A^*; T_S)$

* Package mounted on epoxy

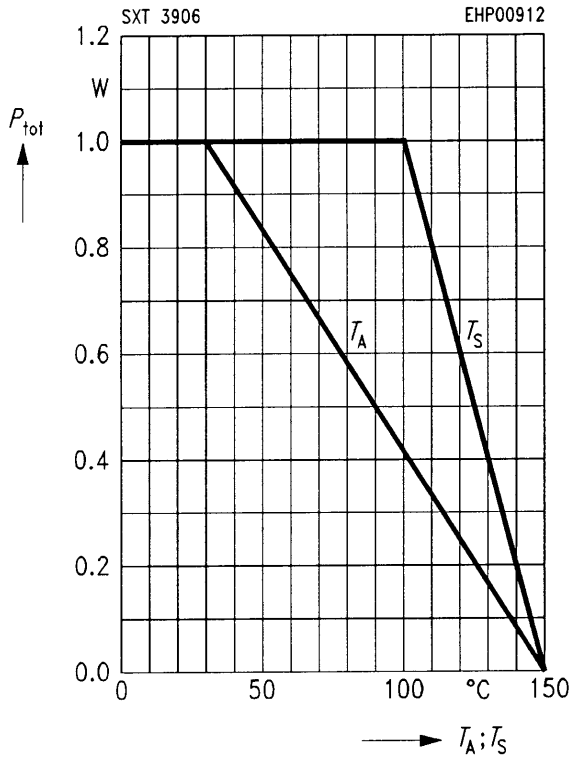

Saturation voltage $I_C = f(V_{BE sat}, V_{CE sat})$

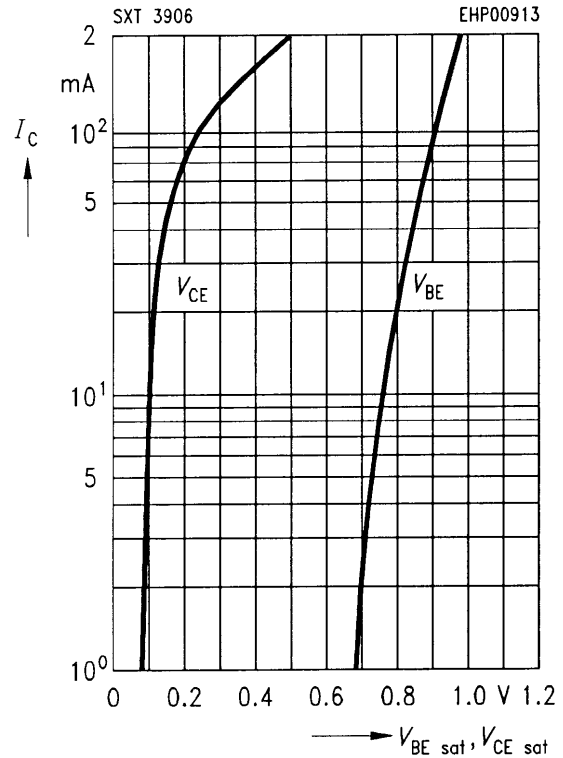

Permissible pulse load $P_{tot max}/P_{tot DC} = f(t_p)$

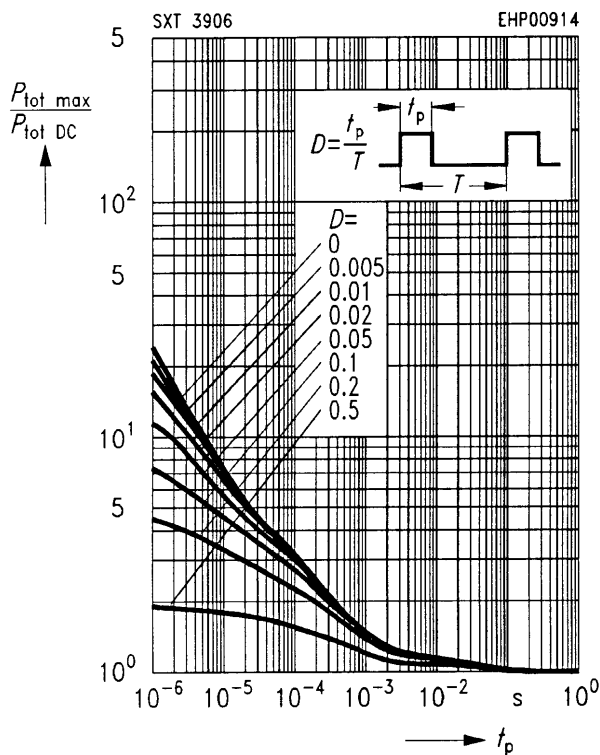

Open-circuit reverse voltage transfer ratio $h_{12e} = f(I_C)$

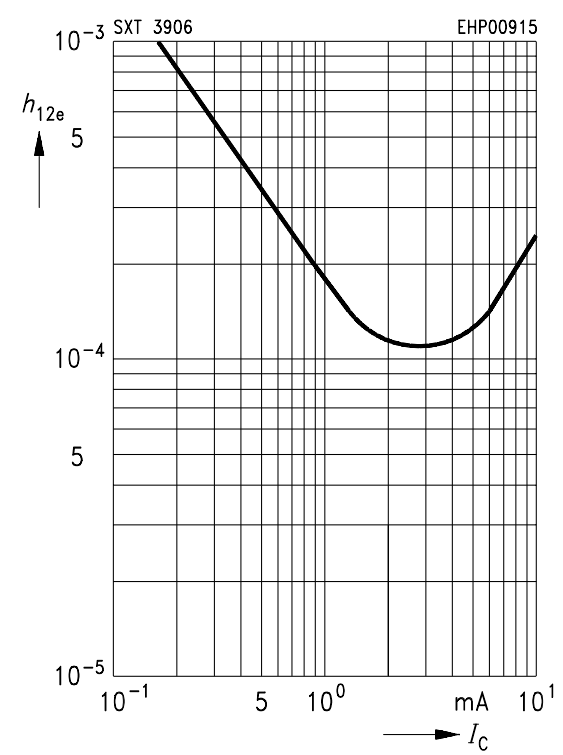

Small-signal current gain

$h_{fe} = f(I_C)$

$V_{CE} = 10\text{ V}, f = 1\text{ MHz}$

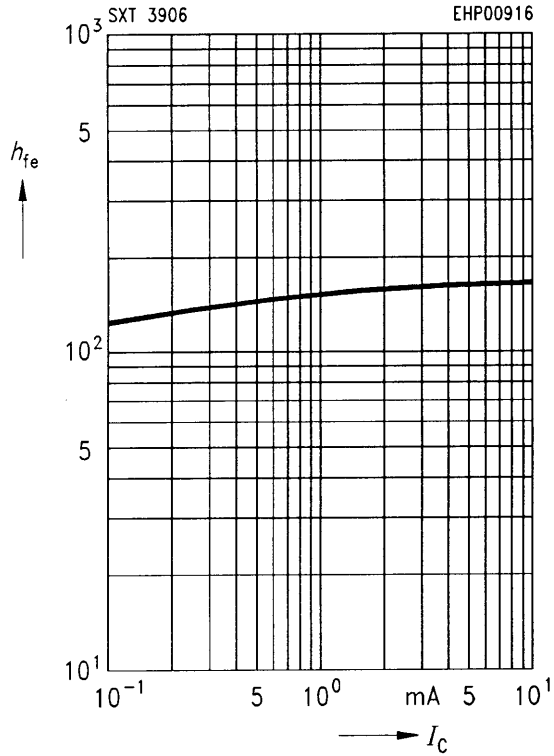

Output admittance

$h_{22e} = f(I_C)$

$V_{CE} = 10\text{ V}, f = 1\text{ MHz}$

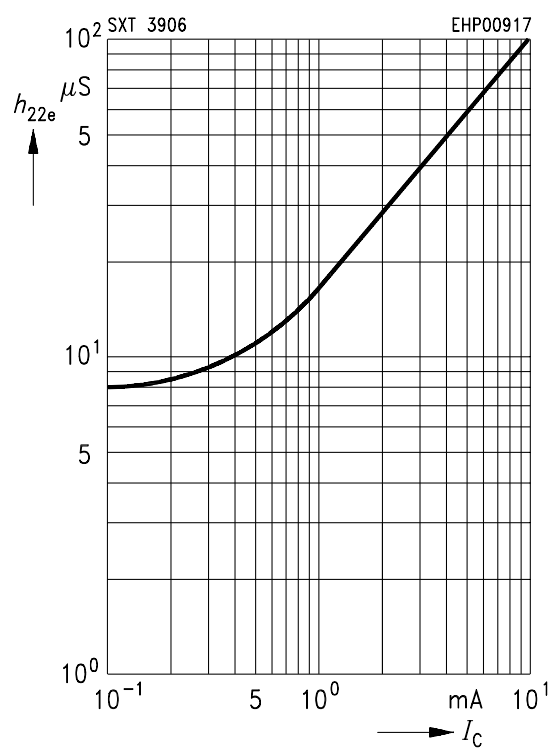

Delay time $t_d = f(I_C)$

Rise time $t_r = f(I_C)$

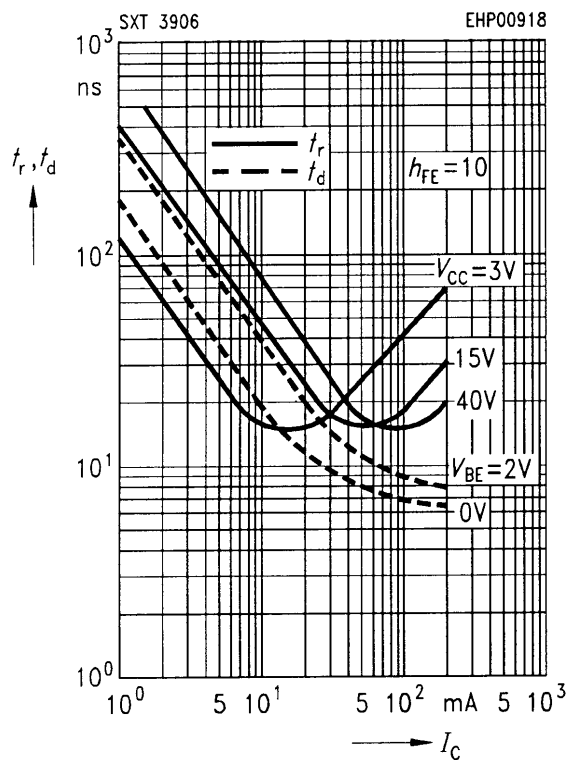

Fall time $t_f = f(I_C)$

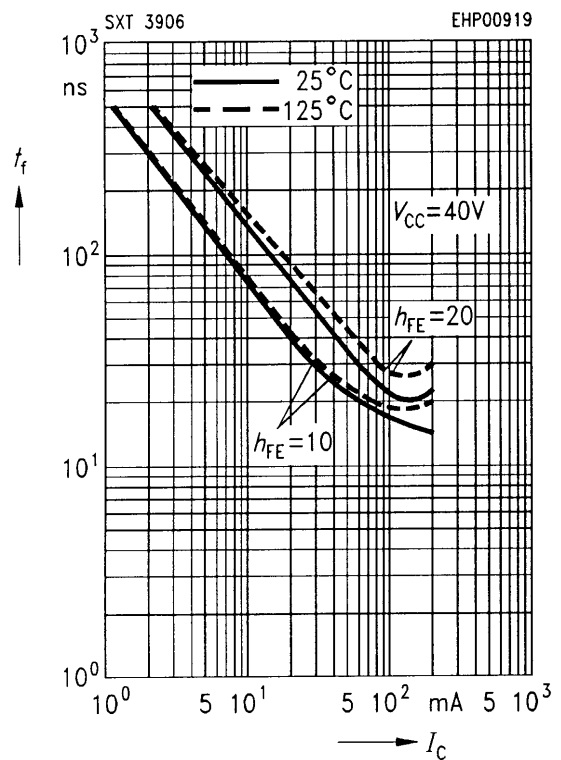

DC current gain $h_{FE} = f(I_C)$

$V_{CE} = 1$ V, normalized

