

## TV VIF & SIF & DEFLECTION SYSTEM (IC FOR TV LARGE INTEGRATION)

The KA2915 is a monolithic integrated circuit containing all stages for the VIF, SIF and deflection functions of television receivers.

### FUNCTIONS

- IF Amp.
- Video Amp.
- IF AGC
- Tuner AFT
- Sound DET. (FM DET.)
- Vertical trig.
- Vertical drive
- Horizontal drive
- Video DET. (AM DET.)
- Noise canceller
- Forward RF AGC
- SIF Amp.
- Sync separation
- Vertical oscillation
- Horizontal oscillation
- Horizontal AFC

### FEATURES

- High integration technology makes possible the integration of video IF circuit a tuner AFC circuit a sound IF circuit a and deflection-jungle circuit a on a single chip.
- Supply voltage range: 8 ~ 12V (Typ. 10V).

28 DIP

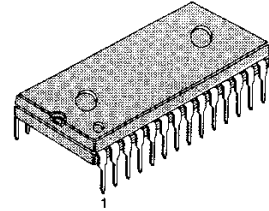

### ORDERING INFORMATION

Device	Package	Operating Temperature
KA2915	28 DIP	-20 ~ +70°C

### BLOCK DIAGRAM

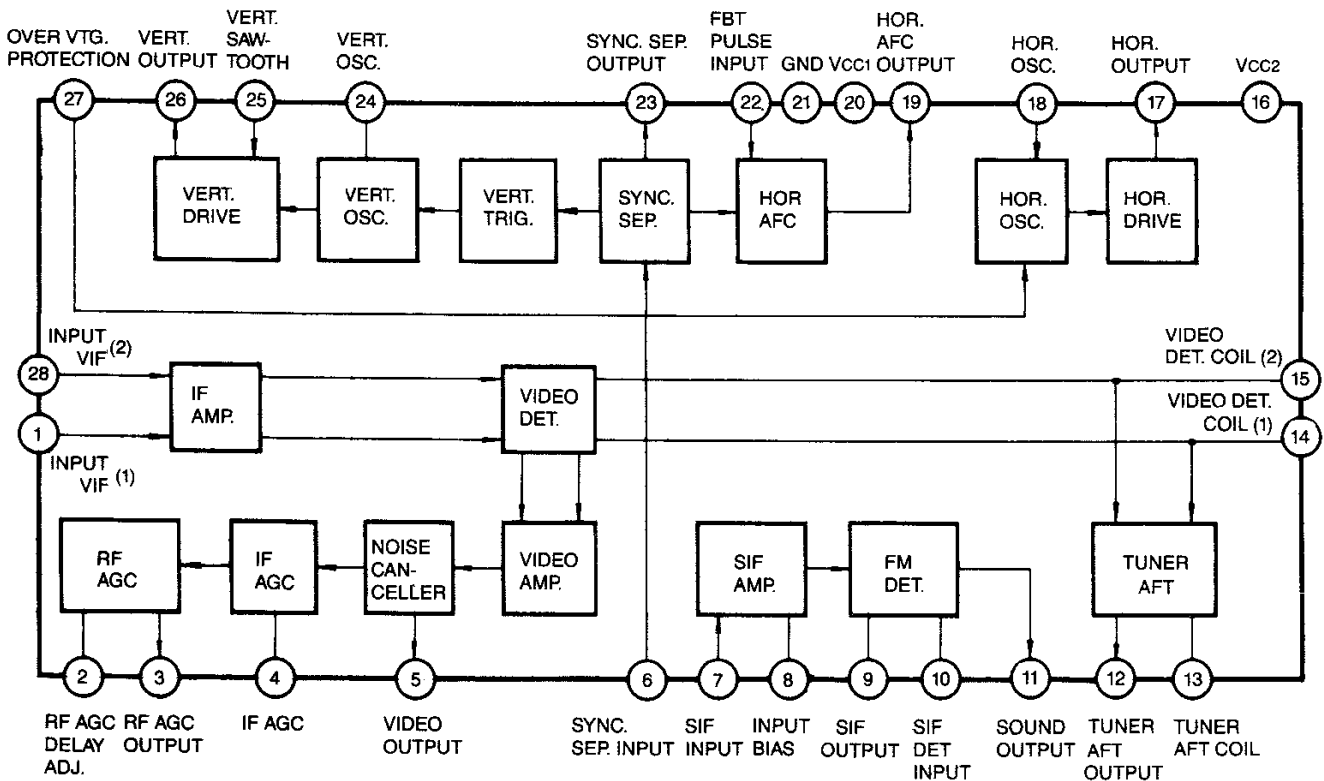

**ABSOLUTE MAXIMUM RATINGS ( $T_a = 25^\circ\text{C}$ )**

Characteristic	Symbol	Value		Unit
Supply Voltage	$V_{CC} (V_{20-21})$	12		V
Supply Current	$I_{20}$	85		mA
	$I_{16}$	15		mA
Circuit Voltage	$V_{2, 3, 4, 24-21}$	$V_{20-21}$	0	V
	$V_{8-21}$	5.5	0	V
	$V_{13-21}$	4.2	0	V
	$V_{17-21}$	$V_{16-21}$	0	V
Circuit Current	$I_{5, 6, 11, 23, 26}$	+0.3	-10	mA (peak)
	$I_{19}$	+0.6	-0.6	mA (peak)
	$I_{25}$	+10	0	mA (peak)
	$I_{17}$	+10	-4	mA (peak)
Power Dissipation ( $T_a = 70^\circ\text{C}$ )	$P_D$	1100		mW
Operating Temperature	$T_{OPR}$	-20 ~ +70		$^\circ\text{C}$
Storage Temperature	$T_{STG}$	-55 ~ +150		$^\circ\text{C}$

**ELECTRICAL CHARACTERISTICS ( $V_{CC1} = 10\text{V}$ ,  $V_{CC} = 9.5\text{V}$ ,  $T_a = 25^\circ\text{C}$ )****Video Section**

Characteristic	Symbol	Test Condition	Min	Typ	Max	Unit
Video Det. Output	$V_O$	$m = 87.5\%$	2.0	2.3	2.6	$V_{p-p}$
Input Sensitivity	$S_{VI}$	$V_O = -3\text{dB}$	-	50	55	$\text{dB}\mu$
Maximum Input	$V_{MAX}$	$V_O > +0\text{dB}$	105	110	-	dB
SN Rating	S/N	$V_I = 80\text{dB}\mu$	51	56	-	dB
Differential Gain	DG	$m = 87.5\%$	-	4	8	%
Differential Phase	DP	$m = 87.5\%$	-	3	6	deg
Video Freq. Characteristic	$G_{V(F)}$	$V_O = -3\text{dB}$	4.5	6.0	8.0	MHz
Sync. Peak Voltage	$V_P$		1.9	2.3	2.7	V
Noise Inverter Output Level	$V_{NT}$		1.0	1.4	1.8	V
Noise Inverter Capture Level	$V_{NI}$		3.0	4.0	5.0	V
Sound IF Output	$V_{SIF}$	$P/S = 20\text{dB}$	100	104	107	$\text{dB}\mu$
Input Resistor	$R_{INI}$	$f = 45.75\text{MHz}$	0.8	1.0	1.2	Kohm
Input Capacitcr	$C_{ZNI}$	$f = 45.75\text{MHz}$	3.0	3.4	3.8	pF
Output Resistor	$R_{O5}$	$f = 500\text{kHz}$	30	50	150	ohm
RF AGC Gain	$G_{RF AGC}$	$f = 10\text{kHz}$ , $V_4 = 5\text{mV}$	36	42	48	dB
RF AGC Max. Voltage	$V_{3(MAX)}$		8.2	8.8	9.4	V
RF AGC Min. Voltage	$V_{3(MIN)}$		3.6	4.2	4.8	V
AFT Center Voltage	$V_2$		4.0	5.4	6.0	V

**Video Section** (Continued)

Characteristic	Symbol	Test Condition	Min	Typ	Max	Unit
AFT SW Operating Voltage	$V_{ART\ SW}$	$R_S = 10K\Omega$	0.5	2.6	3.0	V
AFT Maximum Output Voltage	$V_{12\ (Max.)}$		8.5	9.6	10.0	V
AFT Minimum Output Voltage	$V_2\ (Min.)$		0	0.7	1.2	V
Selection Sensitivity	$\mu$	$R_L = 68K\Omega/82K\Omega$	30	50	90	mV/kHz

**Sound Section**

Characteristic	Symbol	Test Condition	Min	Typ	Max	Unit
Sound Det. Output	$V_O$	$f_O = 4.5MHz, f_m = 400Hz$ $\Delta f = \pm 25kHz, V_i = 100mVrms$	200	300	440	mVrms
Input Limit Voltage	$V_{i\ (LIM)}$	$f = 4.5MHz, f_m = 400Hz$ $\Delta f = \pm 25kHz$	—	280	450	$\mu Vrms$
Total Harmonic Distortion	THD	$f_O = 4.5MHz, f_m = 400Hz$ $\Delta f = \pm 25kHz, V_i = 100mVrms$		0.6	1.0	%
AM Rejection Ratio	AMR		43	55	—	dB
Input Impedance	$R_{17}$	$f = 4.5MHz$	6	20	100	$K\Omega$
	$C_{17}$		1.3	4.3	7.3	pF
Detector Input Impedance	$R_{D9}$	$f = 4.5MHz$	2.0	3.0	4.0	$K\Omega$
	$C_{D9}$		2.1	5.1	8.1	pF
	$R_{D10}$		50	200	—	$K\Omega$
	$C_{D10}$		2.9	3.4	3.9	pF

**Deflection Section**

Characteristic	Symbol	Test Condition	Min	Typ	Max	Unit
Sync Sep. Hori. Pulse Width (1)	$t_{SYNC1}$	Video Input 2.5V <sub>P-P</sub> , APL=50%, $V_{CC1} = 10V$	4.8	5.1	5.4	$\mu s$
Sync Sep. Hori. Pulse Width (2)	$t_{SYNC2}$	Video Input 1.0V <sub>P-P</sub> , APL=50% $V_{CC1} = 10V$	4.9	5.2	5.5	$\mu s$
Hori. AFC Hori. Pulse Width (1)	$t_{SYNC3}$	Video Input 2.5V <sub>P-P</sub> , APL=50% $V_{CC1} = 10V$	4.8	5.1	5.4	$\mu s$
Hori. AFC Hori. Pulse Width (2)	$t_{SYNC4}$	Video Input 1.0V <sub>P-P</sub> , APL=50% $V_{CC1} = 10V$	4.9	5.2	5.5	$\mu s$
Vert Osc, Start Supply Voltage	$V_{FVOS}$	$f_{VO} = 50 \sim 70Hz$ Output=0.7V <sub>P-P</sub>	—	—	6	V
Vert. Free Running Frequency	$f_{VO}$	$R_{OSC(V)} = 31.5K\Omega$	57	60	63	Hz

**Deflection Section (Continued)**

Characteristic	Symbol	Test Condition	Min	Typ	Max	Unit
Vert. OSC. Pulse Width	$t_{VO}$	$R_{OSC(V)} = 31.5K\Omega$	470	650	830	$\mu s$
Vert. full in Range	$f_{V(PULL)}$	$V_{CC1} = 12V, 8V$ $\Delta f_{VO}/V_{CC} = f_{VO(12V)} - f_{VO(8V)}$	0	1.0	1.3	Hz
Vert. Full in Range	$f_{PV}$	Composite Signal Input $2V_{P.P}$	—	44	48	Hz
Hori. OSC. Start Supply Voltage	$V_{FHOS}$	$f_{HO} = 10 \sim 20kHz$ Output = $1V_{P.P}$ Pin 16 Voltage	—	—	5	V
Hori. OSC. Freq.	$f_{HO}$	$R_{OSC(H)} = 21K\Omega$	15.0	15.75	16.25	kHz
Hori. OSC. Pulse Width	$t_{HO}$	$R_{OSC(H)} = 21\Omega$	23	26	29	$\mu s$
Hori. OSC. Freq. Voltage Dependent	$\Delta f_{HO}/V_{CC}$	$V_{CC2} = 10V, 8V$ $\Delta f_{HO}/V_{CC} = f_{HO(10V)} - f_{HO(8V)}$	0	50	100	Hz
Hori. OSC. Control Sensitivity	$\beta$	$\Delta I_1 \pm 100\mu A$ Input Variable OSC. Freq. Variable	73	81	89	Hz/ $\mu A$
Phase Det. Sensitivity	$\mu P$	TV Input $2V_{P.P}$ , $R_{(U)} = 31.4K\Omega, \mu = V19 \times 10$	13.5	16.5	19.5	$\mu A/\mu s$
X-Ray Protector Operating Voltage	$V_{27-21}$		0.81	0.87	0.93	V
X-Ray Protector Input Resistor	$R_{27}$		16	19	22.5	K $\Omega$

# TYPICAL APPLICATION CIRCUIT (12" or 14" B/W TV)

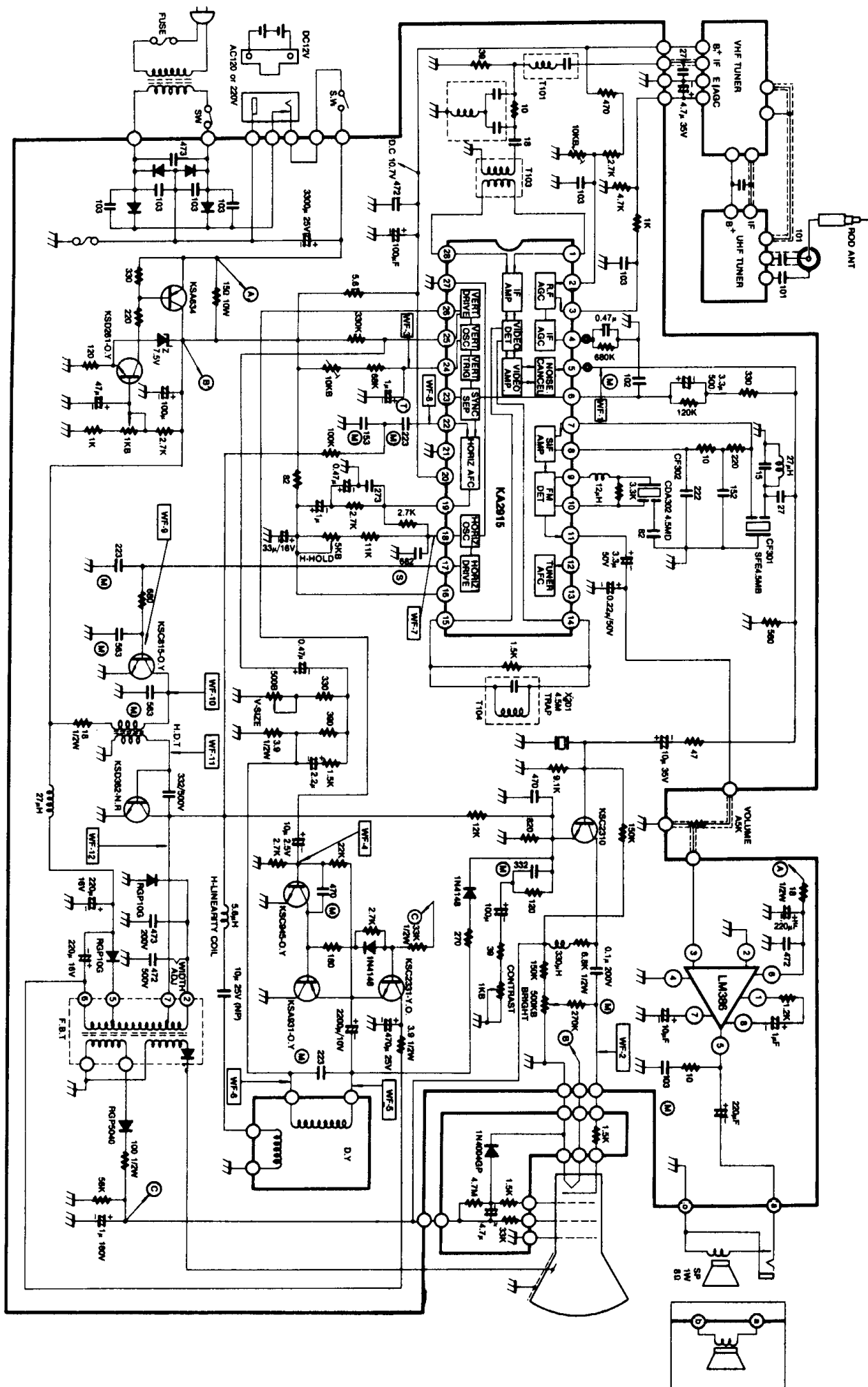

## APPLICATION CIRCUIT (12" or 14" B/W TV) (Continued)

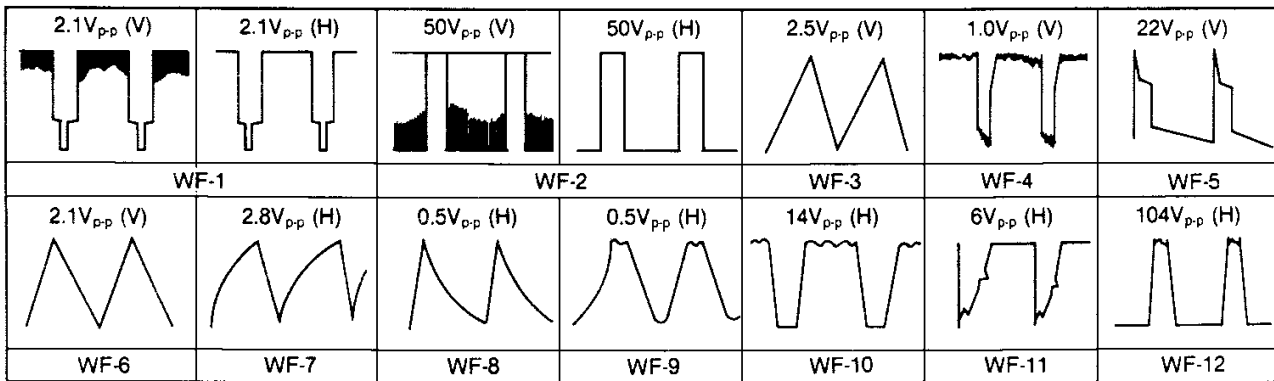

Change the specifications on the following table for your system

Location	System				
	B	D	I	IRELAND	AUSTRALIA
X201	5.5	6.5	6.0	6.0	5.5
CF301	SFE 5.5	SFE 6.5	SFE 6.0	SFE 6.0	SFE 5.5
CF302	CDA 5.5	CDA 6.5	CDA 6.0	CDA 6.0	CDA 5.5

NOTES: 1. All resistance values in ohm K = 1,000 M = 1,000,000.

2. All capacitors not noted in the schematic diagram are in pF the 3rd numeral of the capacitance value indicated  $10^3$  multiplier (EX: 683 → 68,000 pF).

3. Voltage readings taken with V.T.V.M. from the point indicated to chassis ground tuner on an unused channel at max other controls at normal line voltage 120 volts.

4. All waveforms measured with a strong signal input contrast set give a normal picture.

5. Voltage reading may vary 10%.

6. With this fundamental circuit diagram, some production changes may be made without revision of the overall diagram.

## COIL SPECIFICATIONS

### T104 Video Detector Coil

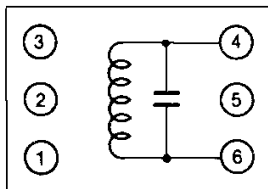

Bottom View

$C_o$ (pF)	$f$ (MHz)	$Q_o$	Turns
4-6		4-6	4-6
51	45.75	100	5 7/8t

Wire: 0.3mm  $\phi$