

# Darlington 2SD2045

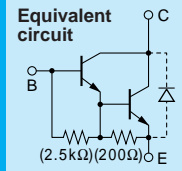

**Silicon NPN Triple Diffused Planar Transistor**

**Application :** Driver for Solenoid, Motor and General Purpose

**Absolute maximum ratings** (Ta=25°C)

Symbol	2SD2045	Unit
V <sub>CB0</sub>	120	V
V <sub>CE0</sub>	120	V
V <sub>EB0</sub>	6	V
I <sub>C</sub>	6(Pulse10)	A
I <sub>B</sub>	1	A
P <sub>C</sub>	50(T <sub>C</sub> =25°C)	W
T <sub>J</sub>	150	°C
T <sub>stg</sub>	-55 to +150	°C

**Electrical Characteristics** (Ta=25°C)

Symbol	Conditions	2SD2045	Unit
I <sub>CB0</sub>	V <sub>CB</sub> =120V	10max	μA
I <sub>EB0</sub>	V <sub>EB</sub> =6V	10max	mA
V <sub>(BR)CEO</sub>	I <sub>C</sub> =10mA	120min	V
h <sub>FE</sub>	V <sub>CE</sub> =2V, I <sub>C</sub> =3A	2000min	
V <sub>CE(sat)</sub>	I <sub>C</sub> =3A, I <sub>B</sub> =3mA	1.5max	V
V <sub>BE(sat)</sub>	I <sub>C</sub> =3A, I <sub>B</sub> =3mA	2.0max	V
f <sub>T</sub>	V <sub>CE</sub> =12V, I <sub>E</sub> =-1A	50typ	MHz
C <sub>OB</sub>	V <sub>CB</sub> =10V, f=1MHz	70typ	pF

**External Dimensions FM100(TO3PF)**

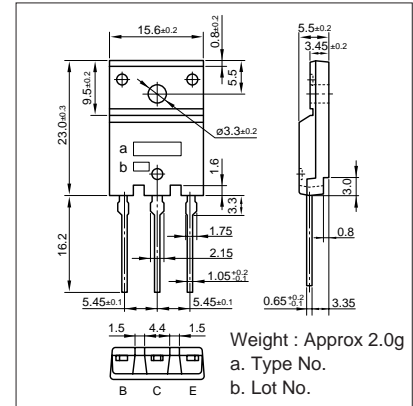

**Typical Switching Characteristics (Common Emitter)**

V <sub>CC</sub> (V)	R <sub>L</sub> (Ω)	I <sub>C</sub> (A)	V <sub>BB1</sub> (V)	V <sub>BB2</sub> (V)	I <sub>B1</sub> (mA)	I <sub>B2</sub> (mA)	t <sub>on</sub> (μs)	t <sub>stg</sub> (μs)	t <sub>f</sub> (μs)
30	10	3	10	-5	3	-3	0.5typ	5.5typ	1.5typ

**I<sub>C</sub>-V<sub>CE</sub> Characteristics (Typical)**

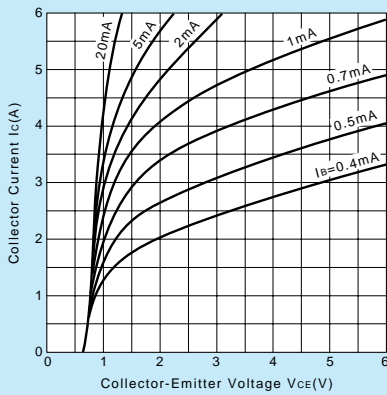

**V<sub>CE(sat)</sub>-I<sub>B</sub> Characteristics (Typical)**

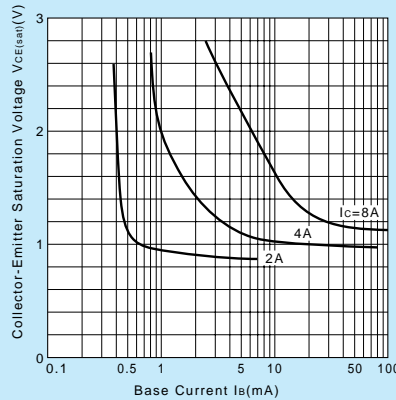

**I<sub>C</sub>-V<sub>BE</sub> Temperature Characteristics (Typical)**

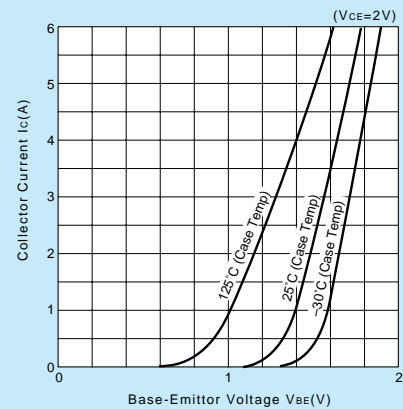

**h<sub>FE</sub>-I<sub>C</sub> Characteristics (Typical)**

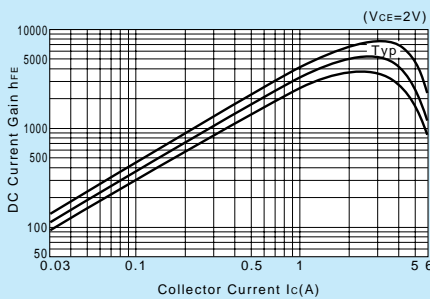

**h<sub>FE</sub>-I<sub>C</sub> Temperature Characteristics (Typical)**

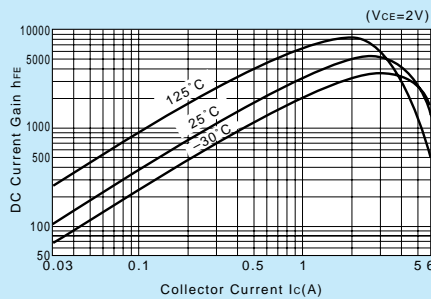

**θ<sub>j-a</sub>-t Characteristics**

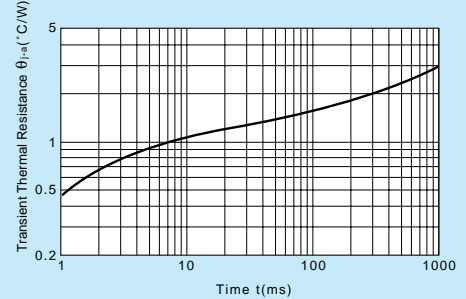

**f<sub>T</sub>-I<sub>E</sub> Characteristics (Typical)**

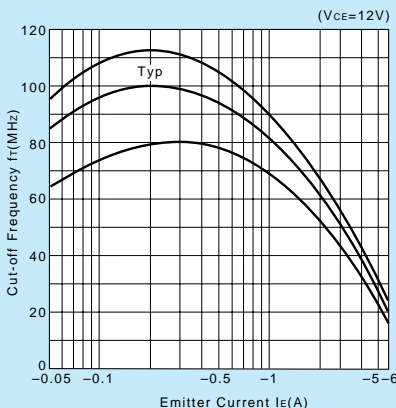

**Safe Operating Area (Single Pulse)**

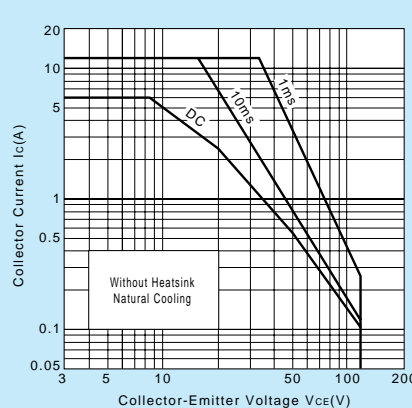

**P<sub>C</sub>-T<sub>a</sub> Derating**

