

# 30A Schottky barrier diode in TO220F package

## FMB-2306

- Feature
  - $I_F = 30A$  in TO220F package
  - $T_j = 150^\circ C$  guaranteed

### Absolute maximum ratings

Parameter	Ratings	Unit	Conditions
$V_{RM}$	60	V	
$I_{F(AV)}$	30	A	
$I_{FSM}$	150	A	10ms Half-cycle sinewave Single Shot
$I^2t$	112	$A^2s$	
$T_j$	-40 to +150	$^\circ C$	
$T_{stg}$	-40 to +150	$^\circ C$	

### Electrical characteristics

( $T_a = 25^\circ C$ )

Parameter	Ratings	Unit	Conditions
$V_F$	0.7max	V	$I_F = 15A$
$I_R$	8.0max	mA	$V_R = V_{RM}$
H.I.R1	115max	mA	$T_j = 125^\circ C, V_R = V_{RM}$
H.I.R2	400max	mA	$T_j = 150^\circ C, V_R = V_{RM}$
$R_{th(j-c)}$	4.0max	$^\circ C/W$	Junction-to-case

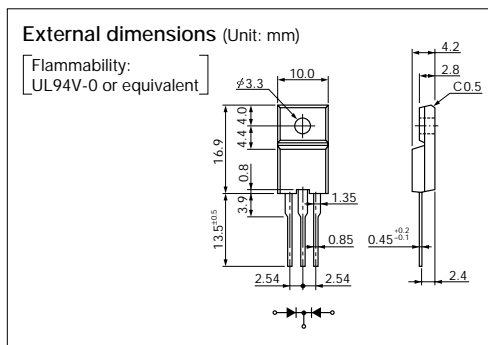
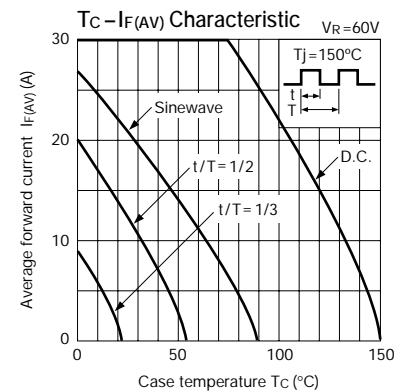
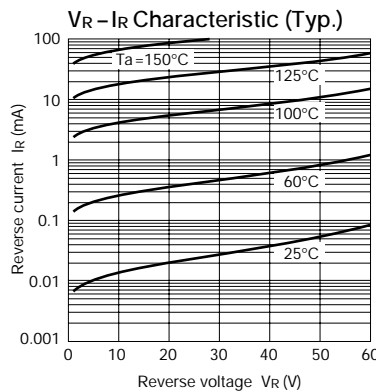
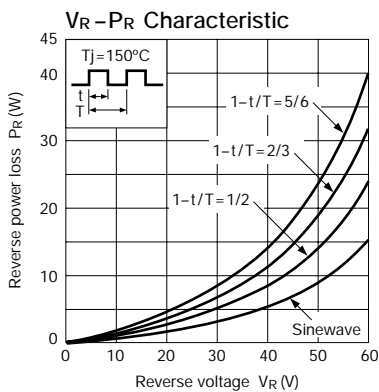
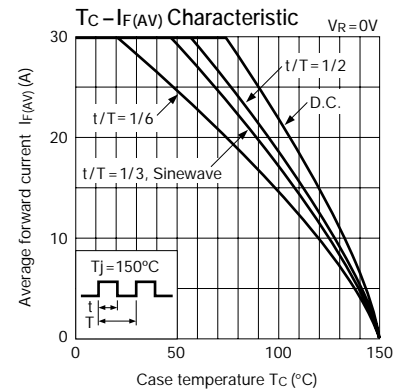
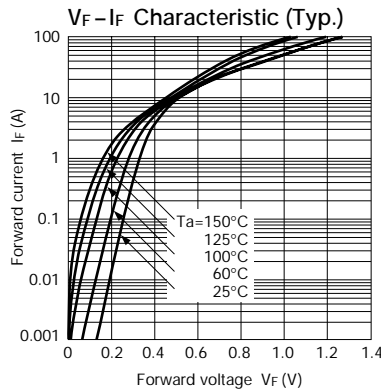
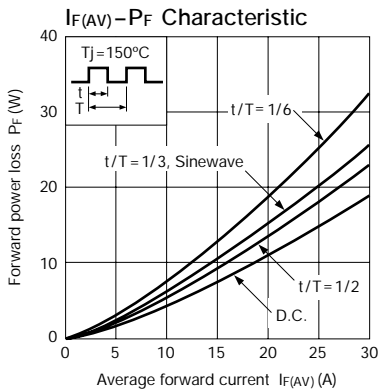

### Reference data

