

Application

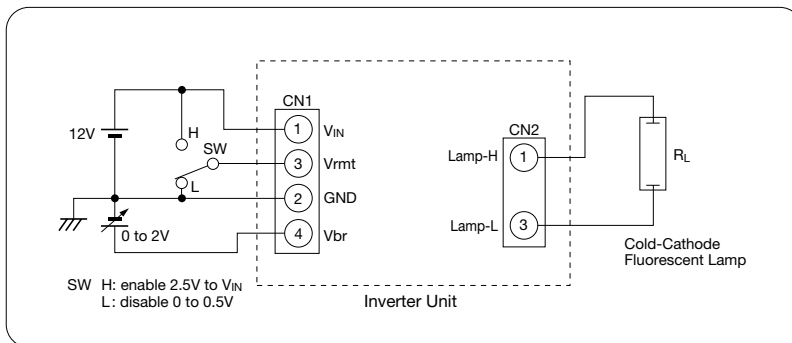

Absolute maximum ratings

Parameter	Symbol	Ratings	Unit	Remarks
DC input voltage	V_{IN}	0 to 16	V	
On/Off voltage	V_{rmt}	0 to 16	V	
Dimming voltage	V_{br}	0 to 2.5	V	
Output power	P_L	4.0	W	
Operating temp.	T_{opr}	0 to 60	°C	
Storage temp.	T_{stg}	-20 to 80	°C	
Humidity	RH	95	%RH	Maximum wet-bulb temp. 38°C No dew condensation

Electrical characteristics

Conditions: at $T_{opr}=25^{\circ}\text{C}$, $V_{IN}=12\text{V}$ (unless otherwise stated)

Parameter	Symbol	Ratings			Unit	Remarks
		min	typ	max		
DC input voltage	V_{IN}	9.6	12	15	V	
Input current	I_{IN}	—	—	500	mA	$V_{IN}=12\text{V}$
Driving frequency	f_{sw}	50	55	60	kHz	$R_L=120\text{k}\Omega$
Output current	I_L	—	6.0	—	mArms	$R_L=120\text{k}\Omega$, $V_{br}=0\text{V}$
		—	3.0	—	mArms	$R_L=120\text{k}\Omega$, $V_{br}=2\text{V}$
Output Power	P_L	—	3.6	—	W	$R_L=120\text{k}\Omega$
Open voltage	V_O	1500	—	—	Vrms	$V_{IN}=9.6\text{V}$, $R_L=100\text{M}\Omega$

Dimming characteristics

