

Square display LEDs

SEL1020 series

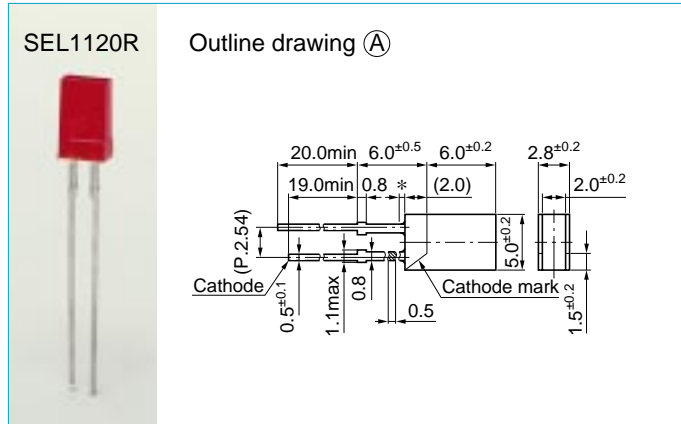

SEL1021 series

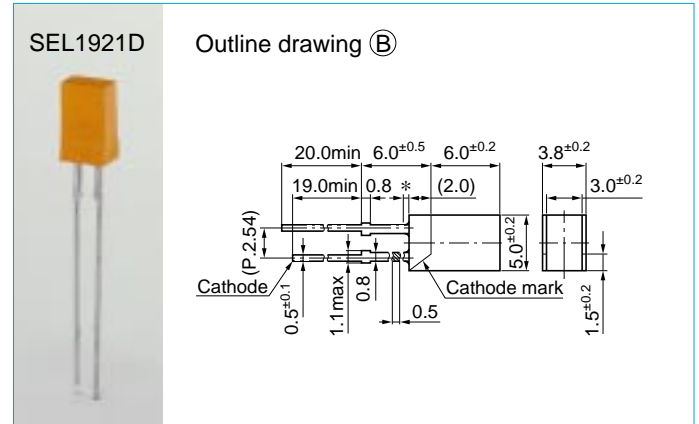

SEL1022 series

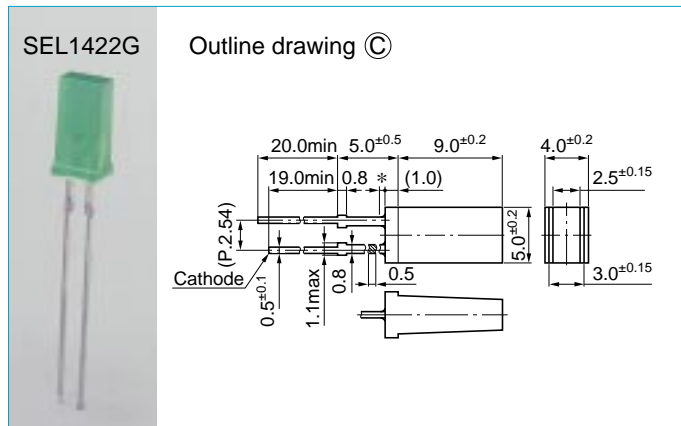



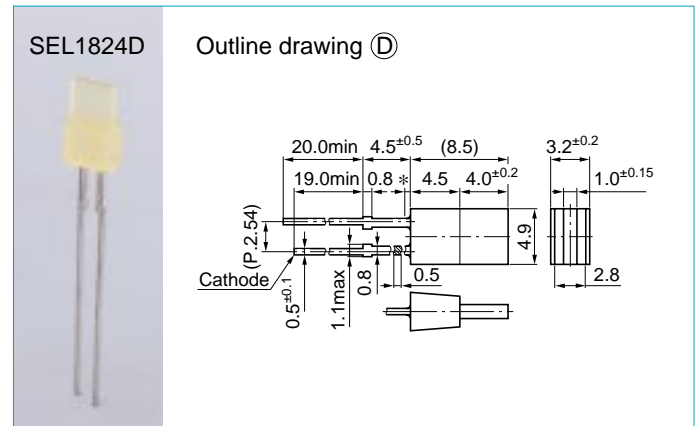

















SEL1024 series



External dimensions: Unit: mm Tolerance: ± 0.3
 * Resin heap: 1.5 mm Max

Absolute maximum ratings (Ta=25°C)

| Symbol | Unit | Ratings |
|-----------------|------|-------------|
| I _F | mA | 30 |
| I _{FP} | mA | 100 |
| V _R | V | 3 |
| Top | °C | -30 to +85 |
| Tstg | °C | -30 to +100 |

| Type No. | Display form (ø: mm) | Type of lens | Emitting color | Electro-optical characteristics (Ta=25°C) | | | | | | | | | Outline drawing |
|----------|---|-------------------------|--------------------|---|-----|-------------------------------|---------------------|------------------------------|----------------------|-------------------------------|----------------|-----|-----------------|
| | | | | V _F (V) | | Condition I _F (mA) | I _R (μA) | Condition V _R (V) | I _v (mcd) | Condition I _F (mA) | λ _p | Δλ | |
| | | | | typ | max | | max | | typ | | (nm) | typ | |
| SEL1120R |  2x5 | Red tinted, diffused | Red | 2.0 | 2.5 | 10 | 50 | 3 | 0.7 | 10 | 700 | 100 | Ⓐ |
| SEL1420G |  2x5 | Green tinted, diffused | Green | | | | | | 2.0 | 20 | 560 | 20 | |
| SEL1720Y |  2x5 | Yellow tinted, diffused | Yellow | 1.9 | 2.5 | 10 | 50 | 3 | 0.7 | 10 | 570 | 40 | |
| SEL1820D |  2x5 | Orange tinted, diffused | Amber | | | | | | 2.0 | | 610 | 35 | |
| SEL1920D |  2x5 | Orange tinted, diffused | Orange | 0.7 | 587 | 33 | | | | | | | |
| SEL1121R |  3x5 | Red tinted, diffused | Red | 2.0 | 2.5 | 10 | 50 | 3 | 0.7 | 10 | 700 | 100 | Ⓑ |
| SEL1421G |  3x5 | Green tinted, diffused | Green | | | | | | 2.0 | 20 | 560 | 20 | |
| SEL1721Y |  3x5 | Yellow tinted, diffused | Yellow | 1.9 | 2.5 | 10 | 50 | 3 | 0.7 | 10 | 570 | 40 | |
| SEL1821D |  3x5 | Orange tinted, diffused | Amber | | | | | | 1.5 | | 610 | 35 | |
| SEL1921D |  3x5 | Orange tinted, diffused | Orange | 0.7 | 587 | 33 | | | | | | | |
| SEL1222R |  2.5x5 | Red tinted, diffused | High intensity red | 1.9 | 2.5 | 10 | 50 | 3 | 5.0 | 20 | 630 | 35 | Ⓒ |
| SEL1422G |  2.5x5 | Green tinted, diffused | Green | 2.0 | | | | | 4.0 | 560 | 20 | | |
| SEL1722Y |  2.5x5 | Yellow tinted, diffused | Yellow | 1.9 | 2.5 | 10 | 50 | 3 | 4.0 | 10 | 570 | 40 | |
| SEL1822D |  2.5x5 | Orange tinted, diffused | Amber | | | | | | 2.5 | | 610 | 35 | |
| SEL1922D |  2.5x5 | Orange tinted, diffused | Orange | 3.0 | 587 | 33 | | | | | | | |
| SEL1124R |  1x4.9 | Red tinted, diffused | Red | 2.0 | 2.5 | 10 | 50 | 3 | 0.7 | 10 | 700 | 100 | Ⓓ |
| SEL1424G |  1x4.9 | Green tinted, diffused | Green | | | | | | 2.0 | 20 | 560 | 20 | |
| SEL1724Y |  1x4.9 | Yellow tinted, diffused | Yellow | 1.9 | 2.5 | 10 | 50 | 3 | 0.7 | 10 | 570 | 40 | |
| SEL1824D |  1x4.9 | Orange tinted, diffused | Amber | | | | | | 2.1 | | 610 | 35 | |
| SEL1924D |  1x4.9 | Orange tinted, diffused | Orange | 0.7 | 587 | 33 | | | | | | | |