

Round-type contact mount LEDs (for automatic insertion)

SEL6010 series (Standard type)

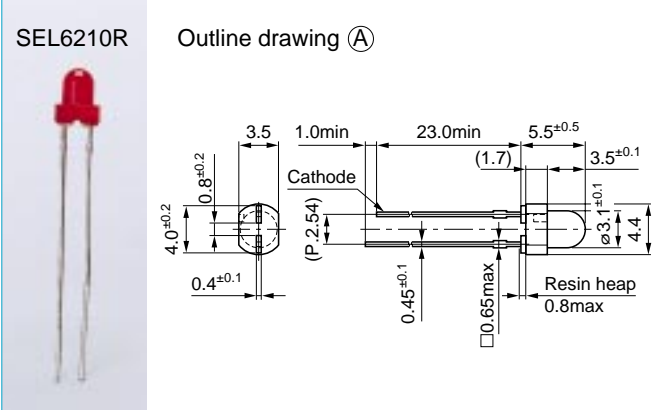

SEL6014 series (Wide viewing angle)

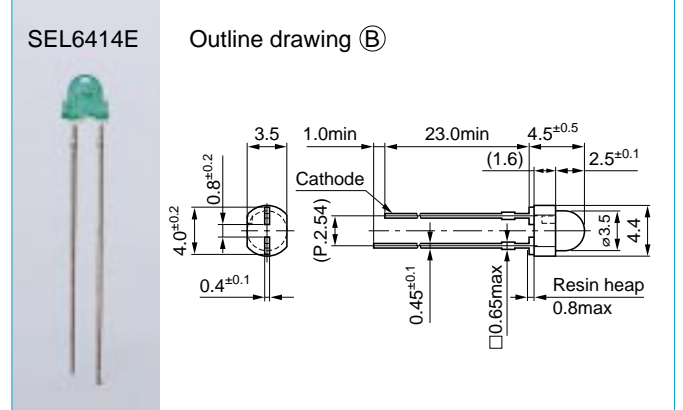

SEL6015 series (Narrow viewing angle)

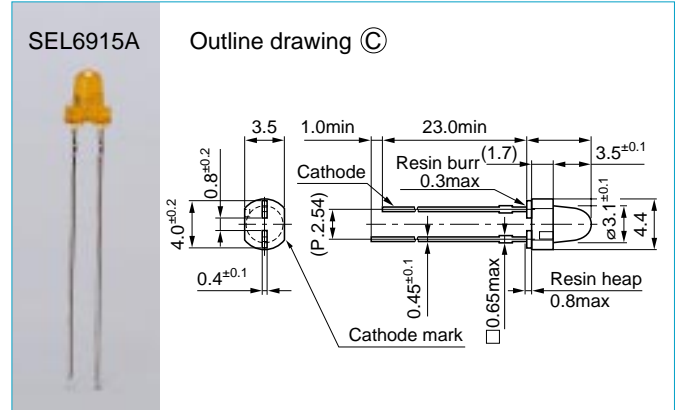

Absolute maximum ratings (Ta=25°C)

Symbol	Unit	Rated
I _F	mA	30
I _{FP}	mA	100
V _R	V	3
Top	°C	-30 to +85
Tstg	°C	-30 to +100

●SEL6000 series LEDs packaged on tapes can withstand shocks caused by insertion machines; Thus, they can be contact-mounted automatically on circuit boards.

Recommended dimensions of insertion holes on printed circuit boards

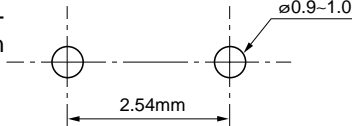

■External dimensions: Unit: mm Tolerance: ±0.3

Viewing angle

SEL6010 series

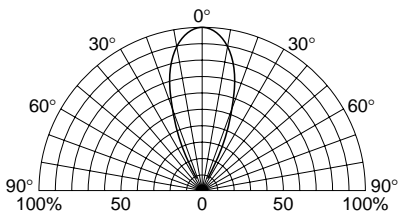

Viewing angle of a non-diffused lens

SEL6014 series

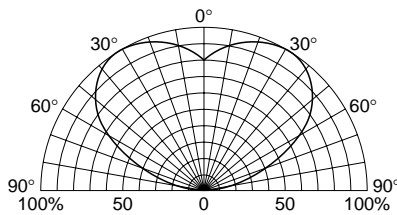

Viewing angle of a non-diffused lens

SEL6015 series

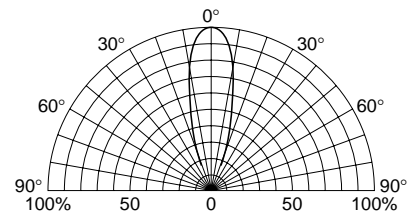

Viewing angle of a non-diffused lens

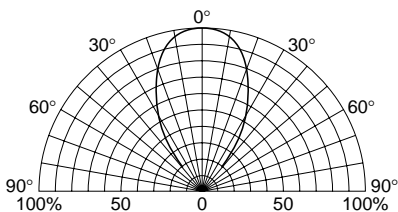

Viewing angle of a diffused lens

Type No.	Display form (\varnothing : mm)	Type of lens	Emitting color	Electro-optical characteristics (Ta=25°C)									Outline drawing
				V _F (V)		Condition I _F (mA)	I _R (μ A)	Condition V _R (V)	I _V (mcd)	Condition I _F (mA)	λ_p (nm)	$\Delta\lambda$ (nm)	
				typ	max								
SEL6210R	●3.1	Red tinted, diffused	High intensity red	1.9	2.5	10	50	3	12	20	630	35	Ⓐ
SEL6210S	●3.1	Red tinted, non-diffused											
SEL6410G	●3.1	Green tinted, diffused	Pure green	2.0	2.5	10	50	3	45	10	555	20	
SEL6410E	●3.1	Green tinted, non-diffused											
SEL6510G	●3.1	Green tinted, diffused	Amber	1.9	2.5	10	50	3	16	10	610	35	
SEL6510C	●3.1	Un-tinted, non-diffused											
SEL6710Y	●3.1	Yellow tinted, diffused	Amber	1.9	2.5	10	50	3	15	10	610	35	
SEL6710K	●3.1	Yellow tinted, non-diffused											
SEL6810D	●3.1	Orange tinted, diffused	Orange	1.9	2.5	10	50	3	10	10	610	35	
SEL6810A	●3.1	Orange tinted, non-diffused											
SEL6910D	●3.1	Orange tinted, diffused	Orange	1.9	2.5	10	50	3	14	10	587	33	
SEL6910A	●3.1	Orange tinted, non-diffused											
SEL6214S	●3.5	Red tinted, non-diffused	High intensity red	1.9	2.5	10	50	3	10	20	630	35	Ⓑ
SEL6414E	●3.5	Green tinted, non-diffused											
SEL6514C	●3.5	Un-tinted, non-diffused	Pure green	2.0	2.5	10	50	3	6	10	555	20	
SEL6814A	●3.5	Orange tinted, non-diffused											
SEL6914A	●3.5	Orange tinted, non-diffused	Orange	1.9	2.5	10	50	3	5	10	587	33	
SEL6215S	●3.1	Red tinted, non-diffused											High intensity red
SEL6415E	●3.1	Green tinted, non-diffused	Green	2.0	2.5	10	50	3	50	20	560	20	
SEL6515C	●3.1	Un-tinted, non-diffused											Pure green
SEL6815A	●3.1	Orange tinted, non-diffused	Amber	1.9	2.5	10	50	3	30	20	610	35	
SEL6915A	●3.1	Orange tinted, non-diffused											Orange

■Using contact mount LEDs packaged on tapes

1. Printed circuit board
 - One-side printed circuit board is recommended.
 - If there are several SMD parts on the same printed circuit board, insert the LEDs after the adhesive for other SMD parts hardened.
2. Insertion conditions
 - Use low insertion pusher pressure, as much as possible.
 - Cut and clinch: Panasert T pattern is recommended.
For N pattern, make the clinching angle of the LED's anode as small as possible.
3. Soldering conditions
 - Preheating must be less than 90°C (temperature on printed circuit board's bottom surface) for no more than two minutes
 - Solder dipping must be made at a temperature of 250°C for no more than 3 seconds.

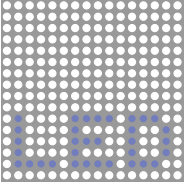

Taping of packaged LEDs with holder (for automatic insertion)

TH12E

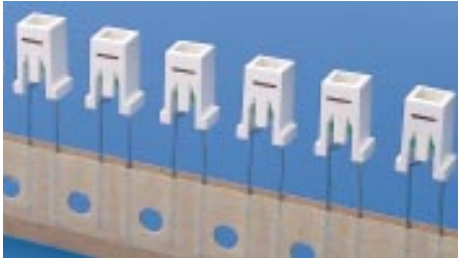

Outline drawing (A)

TH12E

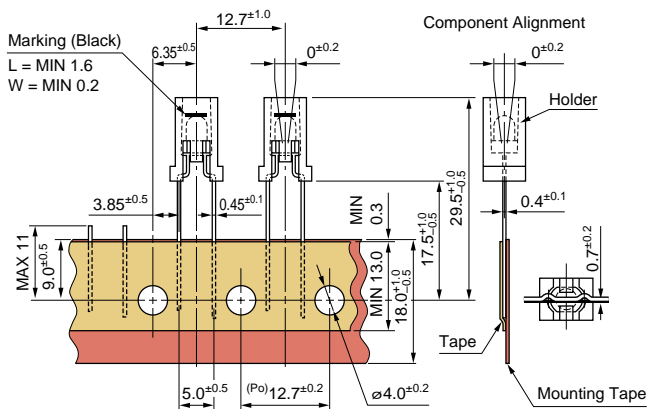

(Po): Cumulative pitch tolerance shall not exceed ± 1.0 mm over 20 consecutive pitches.

Tolerance: ± 0.3

TH10D

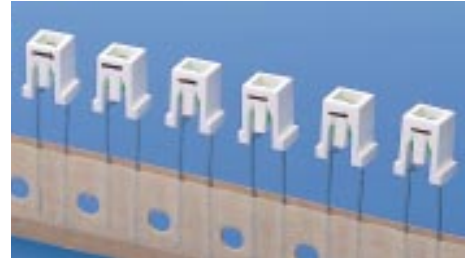

Outline drawing (B)

TH10D

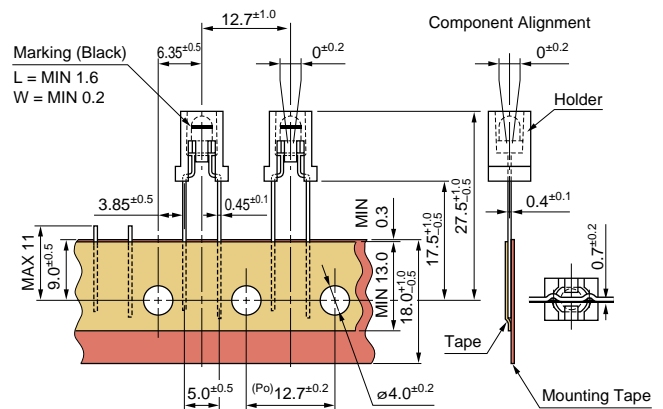

(Po): Cumulative pitch tolerance shall not exceed ± 1.0 mm over 20 consecutive pitches.

Tolerance: ± 0.3

External dimensions: Unit: mm Tolerance: ± 0.3

- Eliminates the cumbersome need to attach holders.
- Available in heights of 12 mm, 10 mm and 8 mm with a luminous area of 4.0 mm × 4.0 mm.
- Available in radial taping configuration with a lead pitch of 5 mm allowing mounting by inserters.

- Available in different colors.
- TH10D and TH12E are holders used for the SEL6010 series. TH8F is a holder used for the SEL5020 and SEL5021 series.

TH8F



Outline drawing ©

TH8F

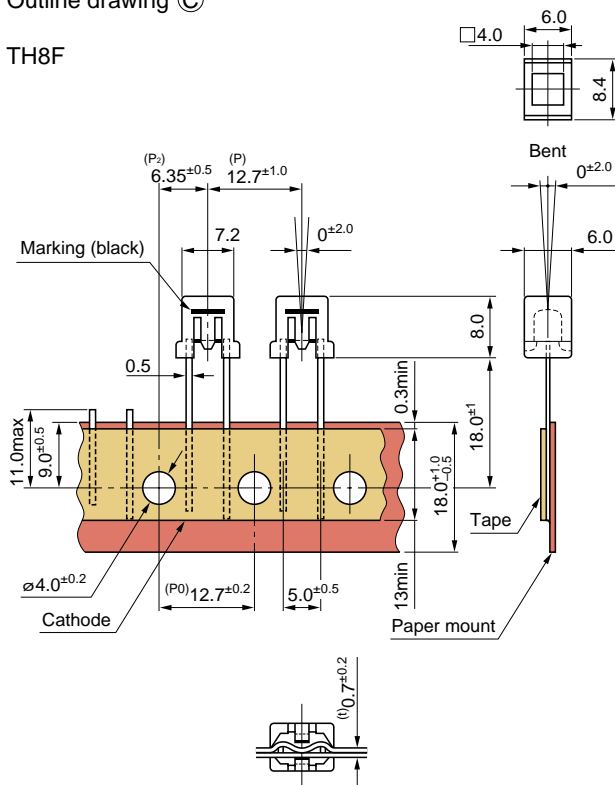

External dimensions: Unit: mm Tolerance: ±0.3

Product list

Type No.	Emitting color
SEL6210S TH12E	High intensity red
SEL6410E TH12E	Green
SEL6510C TH12E	Pure green
SEL6710K TH12E	Yellow
SEL6810A TH12E	Amber
SEL6910A TH12E	Orange
SEL6210S TH10D	High intensity red
SEL6410E TH10D	Green
SEL6510C TH10D	Pure green
SEL6710K TH10D	Yellow
SEL6810A TH10D	Amber
SEL6910A TH10D	Orange
SEL5220S TH8F	High intensity red
SEL5420E TH8F	Green
SEL5520C TH8F	Pure green
SEL5820A TH8F	Amber
SEL5920A TH8F	Orange
SEL5221S TH8F	High intensity red
SEL5421E TH8F	Green
SEL5521C TH8F	Pure green
SEL5821A TH8F	Amber
SEL5921A TH8F	Orange

Quantity per box: 1,200

Recommended dimensions of insertion holes on printed circuit boards (common)

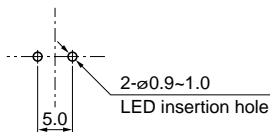

(P₀): The cumulative pitch error must be within ±1.0 for 2.0 pitches.