

SI-3001N Series

3-Terminal, Full-Mold, Low Dropout Voltage Dropper Type

■Features

- Compact full-mold package (equivalent to TO220)
- Output current: 1.5A
- Low dropout voltage: $V_{DIF} \leq 1V$ (at $I_o = 1.5A$)
- Built-in foldback overcurrent, overvoltage, thermal protection circuits

■Applications

- For stabilization of the secondary stage of switching power supplies
- Electronic equipment

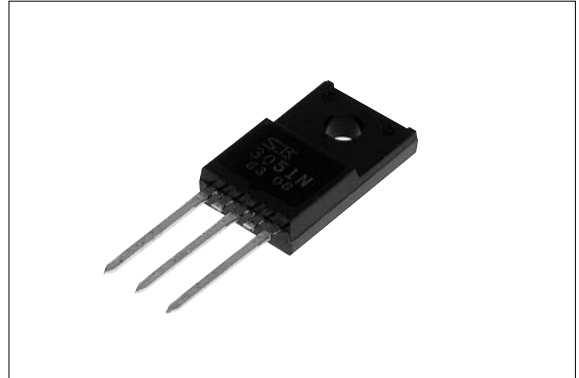

■Absolute Maximum Ratings

($T_a = 25^\circ C$)

Parameter	Symbol	Ratings			Unit
		SI-3051N/3091N	SI-3121N/3151N	SI-3241N	
DC Input Voltage	V_{IN}	35	35	45	V
DC Output Current	I_o	1.5 ²			A
Power Dissipation	P_{D1}	18(With infinite heatsink)			W
	P_{D2}	1.5(Without heatsink, stand-alone operation)			W
Junction Temperature	T_j	-40 to +125			$^\circ C$
Ambient Operating Temperature	T_{op}	-30 to +100			$^\circ C$
Storage Temperature	T_{stg}	-40 to +125			$^\circ C$
Thermal Resistance (junction to case)	$R_{th(j-c)}$	5.5			$^\circ C/W$
Thermal Resistance (junction to ambient air)	$R_{th(j-a)}$	66.7(Without heatsink, stand-alone operation)			$^\circ C/W$

■Electrical Characteristics

(Ta=25°C unless otherwise specified)

Parameter	Symbol	Ratings															Unit
		SI-3051N			SI-3091N			SI-3121N			SI-3151N			SI-3241N			
		min.	typ.	max.	min.	typ.	max.	min.	typ.	max.	min.	typ.	max.	min.	typ.	max.	
Input Voltage	V _{IN}	6 ³		30 ²	10 ³		30 ²	13 ³		30 ²	16 ³		30 ²	25 ³		40 ²	V
Output Voltage	SI-3001N *1	4.80	5.00	5.20	8.64	9.00	9.36	11.52	12.00	12.48	14.40	15.00	15.60	23.04	24.00	24.96	V
	SI-3001NA	4.90	5.00	5.10	8.82	9.00	9.18	11.76	12.00	12.24	14.70	15.00	15.30	23.52	24.00	24.48	
Dropout Voltage	V _{DIF}			0.5			0.5			0.5			0.5			0.5	V
	Conditions	V _{IN} =8V, I _o =1.0A			V _{IN} =12V, I _o =1.0A			V _{IN} =15V, I _o =1.0A			V _{IN} =18V, I _o =1.0A			V _{IN} =27V, I _o =1.0A			
	Conditions	I _o ≤1.0A															
Line Regulation	ΔV _{OLINE}		10	30		18	48		24	64		30	90		48	128	mV
	Conditions	V _{IN} =6V to 15V, I _o =1.0A			V _{IN} =10V to 20V, I _o =1.0A			V _{IN} =13V to 25V, I _o =1.0A			V _{IN} =16V to 27V, I _o =1.0A			V _{IN} =25V to 38V, I _o =1.0A			
	Conditions	I _o ≤1.5A															
Load Regulation	ΔV _{OLOAD}		40	100		70	180		93	240		120	300		120	300	mV
	Conditions	V _{IN} =8V, I _o =0 to 1.5A			V _{IN} =12V, I _o =0 to 1.5A			V _{IN} =15V, I _o =0 to 1.5A			V _{IN} =18V, I _o =0 to 1.5A			V _{IN} =27V, I _o =0 to 1.5A			
Temperature Coefficient of Output Voltage	ΔV _o /ΔT _a		±0.5			±1.0			±1.5			±1.5			±2.5		mV/°C
	Conditions	V _{IN} =8V, I _o =5mA, T _i =0 to 100°C			V _{IN} =12V, I _o =5mA, T _i =0 to 100°C			V _{IN} =15V, I _o =5mA, T _i =0 to 100°C			V _{IN} =18V, I _o =5mA, T _i =0 to 100°C			V _{IN} =27V, I _o =5mA, T _i =0 to 100°C			
Ripple Rejection	R _{REJ}		54			54			54			54			54		dB
	Conditions	V _{IN} =8V, f=100 to 120Hz			V _{IN} =12V, f=100 to 120Hz			V _{IN} =15V, f=100 to 120Hz			V _{IN} =18V, f=100 to 120Hz			V _{IN} =27V, f=100 to 120Hz			
Quiescent Circuit Current	I _q		5	10		5	10		5	10		5	10		5	10	mA
	Conditions	V _{IN} =8V, I _o =0A			V _{IN} =12V, I _o =0A			V _{IN} =15V, I _o =0A			V _{IN} =18V, I _o =0A			V _{IN} =27V, I _o =0A			
Overcurrent Protection Starting Current*4,5	I _{s1}	1.6			1.6			1.6			1.6			1.6			A
	Conditions	V _{IN} =8V			V _{IN} =12V			V _{IN} =15V			V _{IN} =18V			V _{IN} =27V			

*1: "A" may be indicated to the right of the Sanken logo.

*2: V_{IN(max)} and I_{o(max)} are restricted by the relation P_{D(max)}=(V_{IN}-V_o)•I_o=18(W).

*3: Refer to the dropout voltage.(Refer to Setting DC Input Voltage on page 7.)

*4: I_{s1} is specified at -5(%) drop point of output voltage V_o on the condition that V_{IN}=V_o+3V, I_o=1A.

*5: A foldback type overcurrent protection circuit is built into the IC regulator. Therefore, avoid using it for the following applications as it may cause starting errors:

- (1) Constant current load (2) Plus/minus power (3) Series power (4) V_o adjustment by raising ground voltage

■Outline Drawing

(unit:mm)

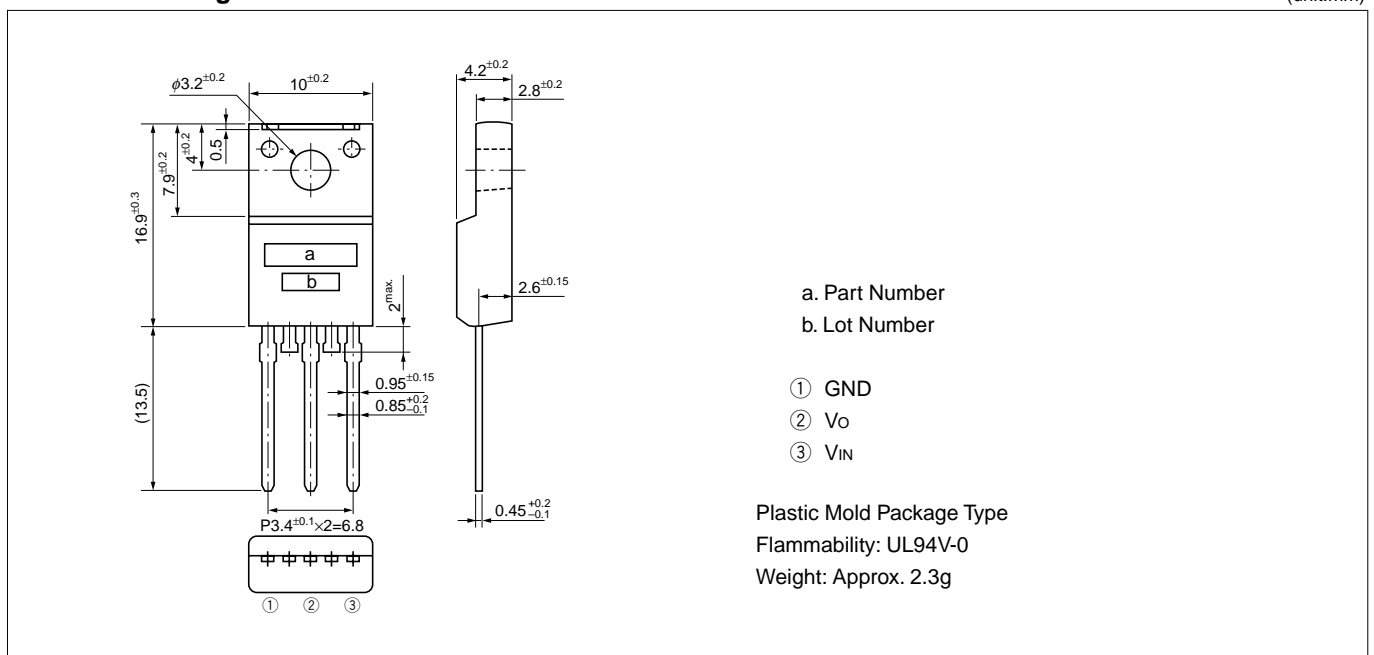

■Block Diagram

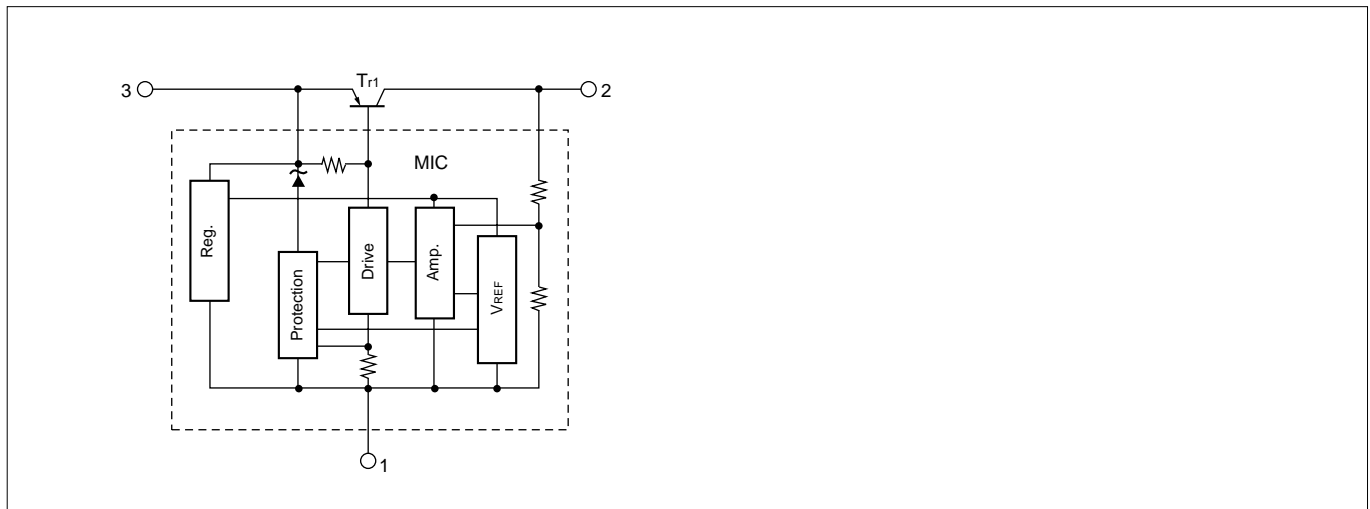

■Standard External Circuit

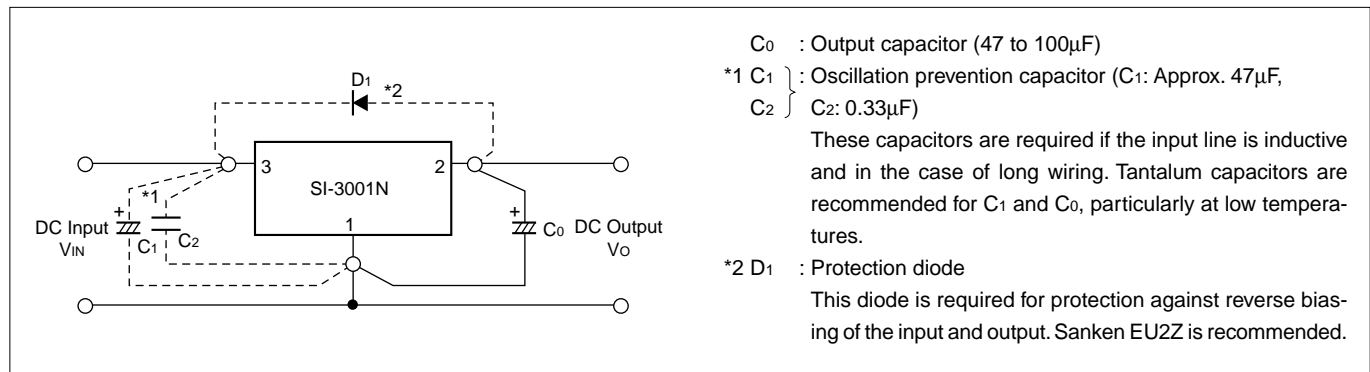

■ T_a - P_D Characteristics

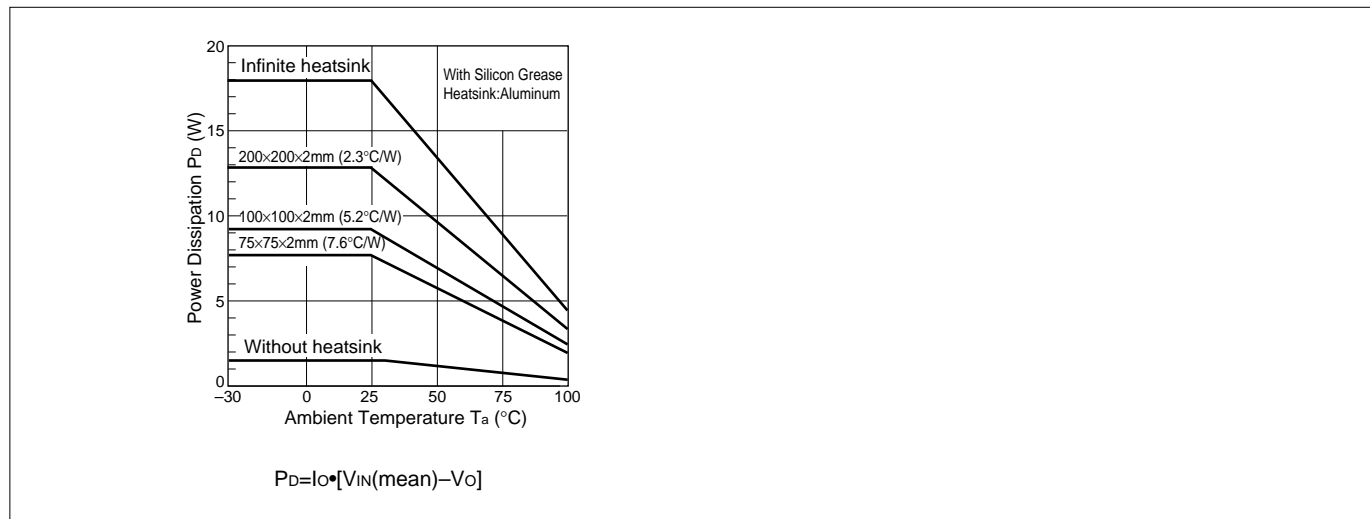

■Typical Characteristics

($T_a=25^\circ\text{C}$)

Io vs. VdIF Characteristics

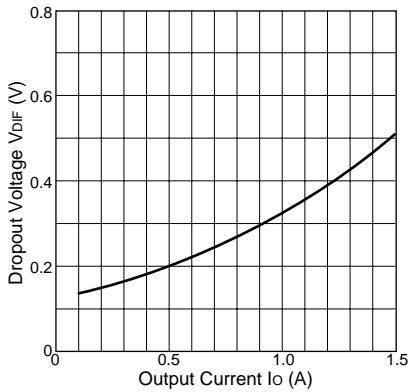

Temperature Coefficient of Output Voltage(SI-3051N)

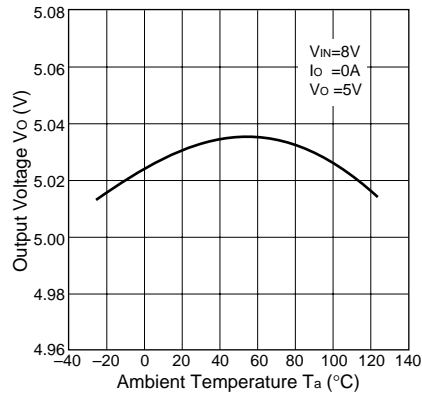

Circuit Current(SI-3051N)

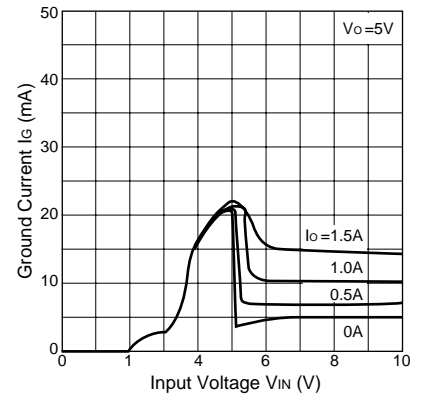

Rise Characteristics(SI-3051N)

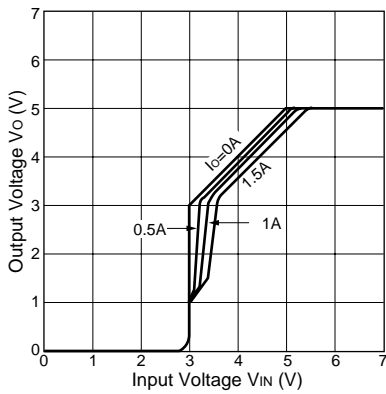

Rise Characteristics(SI-3121N)

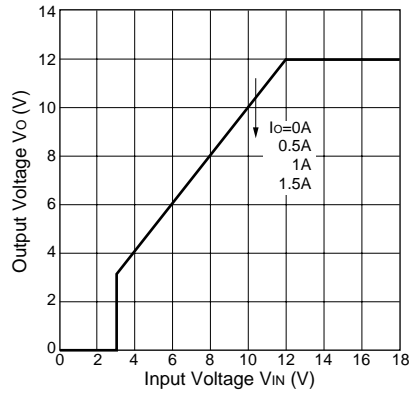

Rise Characteristics(SI-3241N)

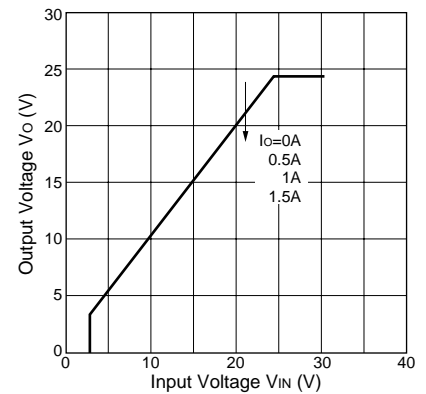

Overcurrent Protection Characteristics(SI-3051N)

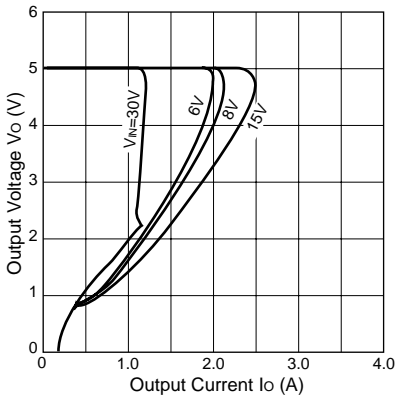

Overcurrent Protection Characteristics(SI-3121N)

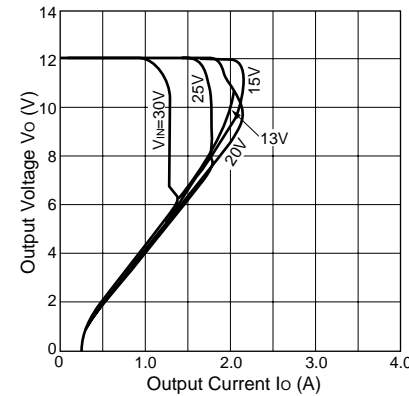

Overcurrent Protection Characteristics(SI-3241N)

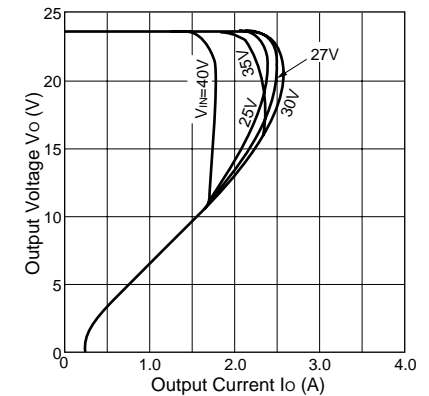

Thermal Protection Characteristics(SI-3051N)

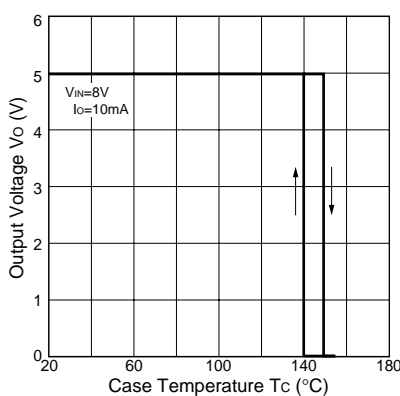

Note on Thermal Protection:

The thermal protection circuit is intended for protection against heat during instantaneous short-circuiting. Its operation is not guaranteed for short-circuiting over extended periods of time.