

Dropper Type Dual Output Regulator SI-3102S

Features

- Single input dual output <sub output (5V/0.04A), main output (5V/0.1A)>
- Main output can be externally turned ON/OFF (with ignition switch, etc.)
<most suitable as memory backup power supply>
- Low standby current ($\leq 0.8\text{mA}$)
- Low dropout voltage $\leq 1\text{V}$
- Built-in constant current type overcurrent, overvoltage and thermal protection circuits
- TO-220 equivalent 5-terminal full-mold miniature package

Absolute Maximum Ratings

($T_a = 25^\circ\text{C}$)

Parameter	Symbol	Ratings	Unit	Conditions
DC input voltage	V_{IN}	35	V	
Battery reverse connection	V_{INB}	-13 ^{*6}	V	One minute
Output control terminal voltage	V_C	V_{IN}	V	
Output current	CH1	I_{O1}	0.04 ^{*1}	A
	CH2	I_{O2}	0.1 ^{*1}	A
Power Dissipation	P_{D1}	22	W	With infinite heatsink
	P_{D2}	1.8	W	Stand-alone without heatsink
Junction temperature	T_J	-40 to +150	$^\circ\text{C}$	
Operating temperature	T_{OP}	-40 to +105	$^\circ\text{C}$	
Storage temperature	T_{stg}	-40 to +150	$^\circ\text{C}$	
Junction to case thermal resistance	θ_{J-C}	5.5	$^\circ\text{C/W}$	
Junction to ambient-air thermal resistance	θ_{J-a}	66.7	$^\circ\text{C/W}$	Stand-alone without heatsink

Electrical Characteristics

($T_J = 25^\circ\text{C}$, $V_{IN} = 14\text{V}$ unless otherwise specified)

Parameter	Symbol	Ratings			Unit	Conditions	
		min	typ	max			
Input voltage	V_{IN}	6 ^{*2}		30 ^{*1}	V		
Output voltage	CH1	V_{O1}	4.80	5.00	5.20	V	$I_O = 0.04\text{A}$
	CH2	V_{O2}	4.80	5.00	5.20	V	$I_O = 0.1\text{A}$
Channel-channel voltage difference ($V_{O1} - V_{O2}$)	ΔV_O	-0.3		5.3	V	$V_{IN} = 0$ to 40V , I_{O1} and $I_{O2} = 0\text{A}$ up to load short-circuiting	
Dropout voltage	CH1	V_{DIF1}		1.0	V	$I_{O1} \cong 0.04\text{A}$	
	CH2	V_{DIF2}		1.0	V	$I_{O2} \cong 0.1\text{A}$	
Line regulation	CH1	$\Delta V_{O LINE1}$	10	50	mV	$V_{IN} = 6$ to 30V , $I_O = 0.04\text{A}$	
	CH2	$\Delta V_{O LINE2}$	10	50	mV	$V_{IN} = 6$ to 30V , $I_O = 0.1\text{A}$	
Load regulation	CH1	$\Delta V_{O LOAD1}$	30	70	mV	$I_{O1} = 0$ to 0.04A	
	CH2	$\Delta V_{O LOAD2}$	40	70	mV	$I_{O2} = 0$ to 0.1A	
Ripple rejection	CH1	R_{REJ1}	54		dB	$f = 100$ to 120Hz	
	CH2	R_{REJ2}	54		dB	$f = 100$ to 120Hz	
Quiescent circuit current	I_q			0.8	mA	$I_{O1} = 0\text{A}$, $V_C = 0\text{V}$	
Overcurrent protection starting current	CH1	$I_{(S)1}$	0.06 ^{*3}		A		
	CH2	$I_{(S)2}$	0.15 ^{*3}		A		
Output control voltage	Output ON	V_{CH}	4.2	4.5	4.8	V	
	Output OFF	V_{CL}	3.2	3.5	3.8	V	
Output control current	Output ON	I_{CH}			100	μA	$V_C = 4.8\text{V}$
	Output OFF	I_{CL}	-100			μA	$V_C = 3.2\text{V}$
Overvoltage protection starting voltage	V_{OVP}	30 ^{*4}			V		
Thermal protection starting temperature	T_{TSD}	151 ^{*5}			$^\circ\text{C}$		

Notes:

1. Since $P_{D(max)} = (V_{IN} - V_O) \cdot I_{O1} + (V_{IN} - V_{O2}) \cdot I_{O2} = 22\text{ (W)}$, $V_{IN(max)}$, $I_{O1(max)}$ and $I_{O2(max)}$ may be limited depending on operating conditions. Refer to the $T_a - P_D$ curve to compute the corresponding values.
2. Refer to the dropout voltage.
3. I_{S1} rating shall be the point at which the output voltage V_{O1} or V_{O2} ($V_{IN} = 14\text{V}$, $I_{O1} = 0.04\text{A}$ or $I_{O2} = 0.1\text{A}$) drops to -5%.
4. Overvoltage protection circuit is built only in CH2 (V_{O2} side).
5. The indicated temperatures are junction temperatures.
6. All terminals, except V_{IN} and GND, are open.

External Dimensions (unit: mm)

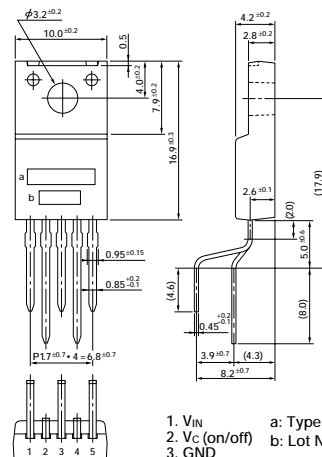

1. V_{IN}
 2. V_C (on/off)
 3. GND
 4. V_{O1}
 5. V_{O2}
- a: Type No.
b: Lot No.
- (Forming No. 1101)

Equivalent Circuit Diagram

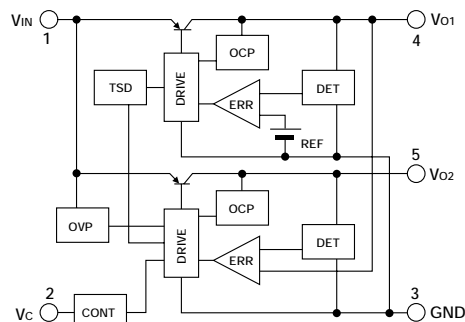

Standard Circuit Diagram

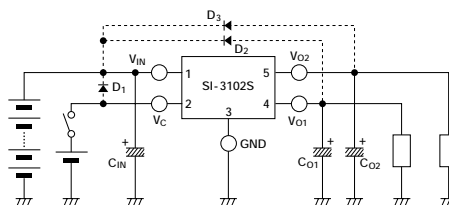

- C_{O1} : Output capacitor (47 to $100\mu\text{F}$, 50V)
 C_{O2} : Output capacitor (47 to $100\mu\text{F}$, 50V)
 $*1 C_{IN}$: Anti-oscillation capacitors (approx. $47\mu\text{F}$).
 Tantalum capacitors are recommended, especially at low temperatures.
 $*2 D_1, D_2, D_3$: Protection diode.
 Required as protection against reverse biasing between input and output.
 (Recommended diode: Sanken EU2Z.)

■ Line Regulation (1)

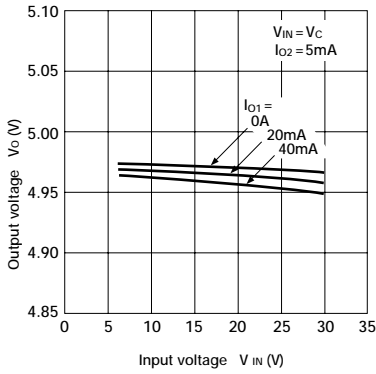

■ Line Regulation (2)

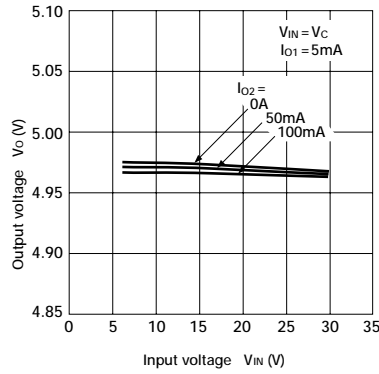

■ Load Regulation (1)

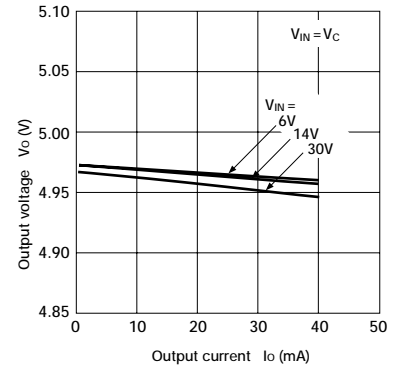

■ Load Regulation (2)

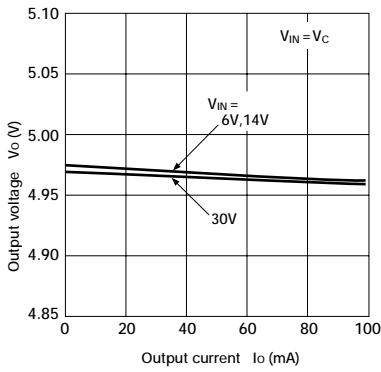

■ Rise Characteristics

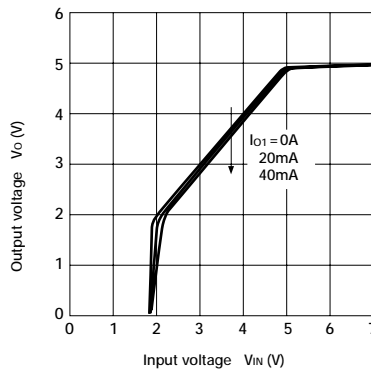

■ Circuit Current

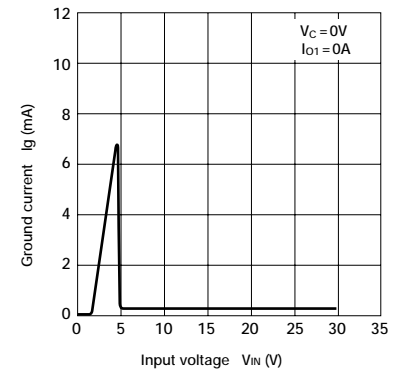

■ ON/OFF Control Characteristics

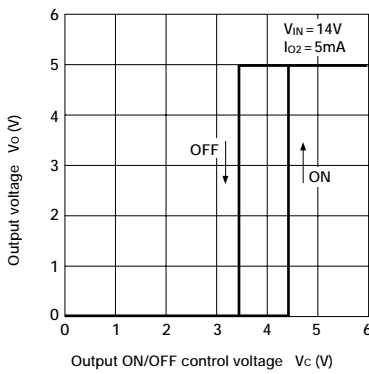

■ Overcurrent Protection Characteristics (1)

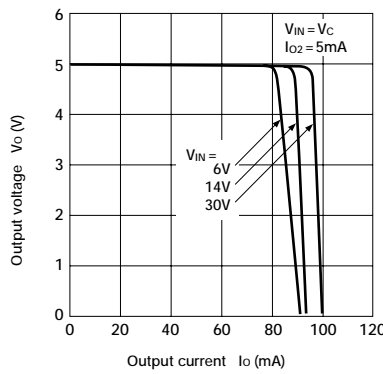

■ Overcurrent Protection Characteristics (2)

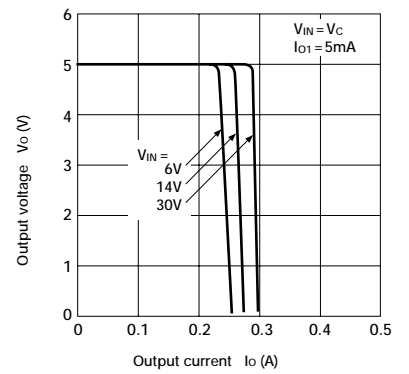

■ Thermal Protection Characteristics

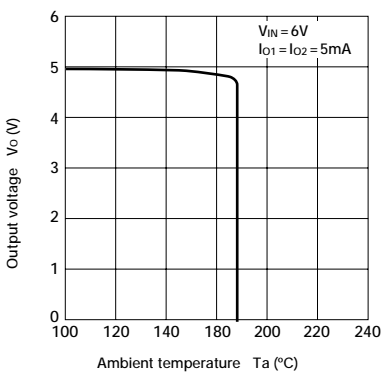

■ Overvoltage Protection Characteristics

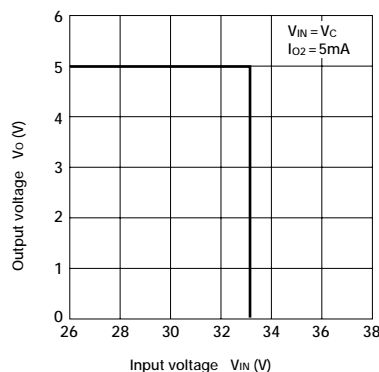

■ Ta—Pd Characteristics

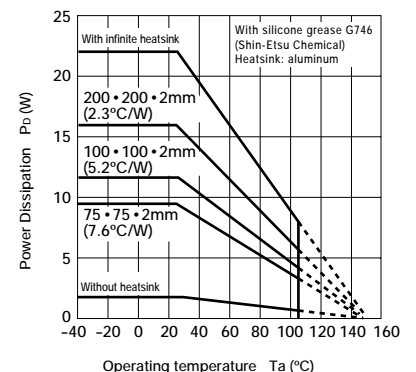

Note on Thermal Protection Characteristics:
The thermal protection circuit is intended for protection against heat during instantaneous short-circuiting. Its operation, including reliability, is not guaranteed for short-circuiting over an extended period of time.