

SI-8000S Series

Full-Mold, Separate Excitation Switching Type

■Features

- Compact full-mold package (equivalent to TO220)
- Output current: 3.0A
- High efficiency: 79 to 91%
- Requires only 4 external components
- Phase correction and output voltage adjustment performed internally
- Built-in reference oscillator (60kHz)
- Built-in overcurrent and thermal protection circuits
- Built-in soft start circuit (output ON/OFF control)



■Applications

- Power supplies for telecommunication equipment
- Onboard local power supplies

■Lineup

Part Number	SI-8033S	SI-8050S	SI-8090S	SI-8120S	SI-8150S
Vo(V)	3.3	5.0	9.0	12.0	15.0
Io(A)	3.0				

■Absolute Maximum Ratings

Parameter	Symbol	Ratings	Unit
DC Input Voltage	V _{IN}	43*	V
Power Dissipation	P _{D1}	18(With infinite heatsink)	W
	P _{D2}	1.5(Without heatsink, stand-alone operation)	W
Junction Temperature	T _j	+125	°C
Storage Temperature	T _{stg}	-40 to +125	°C
SW Terminal Applied Reverse Voltage	V _{sw}	-1	V
Thermal Resistance(junction to case)	R _{th(j-c)}	5.5	°C/W

*SI-8033S: 35V

■Recommended Operating Conditions

Parameter	Symbol	Ratings					Unit
		SI-8033S	SI-8050S	SI-8090S	SI-8120S	SI-8150S	
DC Input Voltage Range	V _{IN}	5.5 to 28	7 to 40	12 to 40	15 to 40	18 to 40	V
Output Current Range	I _o	0 to 3.0					A
Operating Junction Temperature Range	T _{jop}	-30 to +125					°C

■Electrical Characteristics

(Ta=25°C)

Parameter	Symbol	Ratings															Unit
		SI-8033S			SI-8050S			SI-8090S			SI-8120S			SI-8150S			
		min.	typ.	max.	min.	typ.	max.	min.	typ.	max.	min.	typ.	max.	min.	typ.	max.	
Output Voltage	SI-8000S *1	3.17	3.30	3.43	4.80	5.00	5.20	8.55	9.00	9.45	11.50	12.00	12.50	14.25	15.00	15.75	V
	SI-8000SS	3.234	3.30	3.366	4.90	5.00	5.10	8.73	9.00	9.27	—			—			
	Conditions	VIN=15V, Io=1.0A			VIN=20V, Io=1.0A			VIN=21V, Io=1.0A			VIN=24V, Io=1.0A			VIN=25V, Io=1.0A			
Efficiency	η		79			84			88			90			91		%
	Conditions	VIN=15V, Io=1.0A			VIN=20V, Io=1.0A			VIN=21V, Io=1.0A			VIN=24V, Io=1.0A			VIN=25V, Io=1.0A			
Switching Frequency	f		60			60			60			60			60		kHz
	Conditions	VIN=15V, Io=1.0A			VIN=20V, Io=1.0A			VIN=21V, Io=1.0A			VIN=24V, Io=1.0A			VIN=25V, Io=1.0A			
Line Regulation	ΔV _{OLINE}		25	80		40	100		50	120		60	130		60	130	mV
	Conditions	VIN=8 to 28V, Io=1.0A			VIN=10 to 30V, Io=1.0A			VIN=15 to 30V, Io=1.0A			VIN=18 to 30V, Io=1.0A			VIN=21 to 30V, Io=1.0A			
Load Regulation	ΔV _{OLOAD}		10	30		10	40		10	40		10	40		10	40	mV
	Conditions	VIN=15V, Io=0.5 to 1.5A			VIN=20V, Io=0.5 to 1.5A			VIN=21V, Io=0.5 to 1.5A			VIN=24V, Io=0.5 to 1.5A			VIN=25V, Io=0.5 to 1.5A			
Temperature Coefficient of Output Voltage	ΔVo/ΔTa		±0.5			±0.5			±1.0			±1.0			±1.0		mV/°C
Ripple Rejection	R _{REJ}		45			45			-45			45			45		dB
	Conditions	f=100 to 120Hz			f=100 to 120Hz			f=100 to 120Hz			f=100 to 120Hz			f=100 to 120Hz			
Overcurrent Protection Starting Current	Is1	3.1			3.1			3.1			3.1			3.1			A
Conditions	VIN=15V			VIN=20V			VIN=21V			VIN=24V			VIN=25V				

*1: "S" may be indicated to the right of the Sanken logo.

■Outline Drawing

(unit: mm)

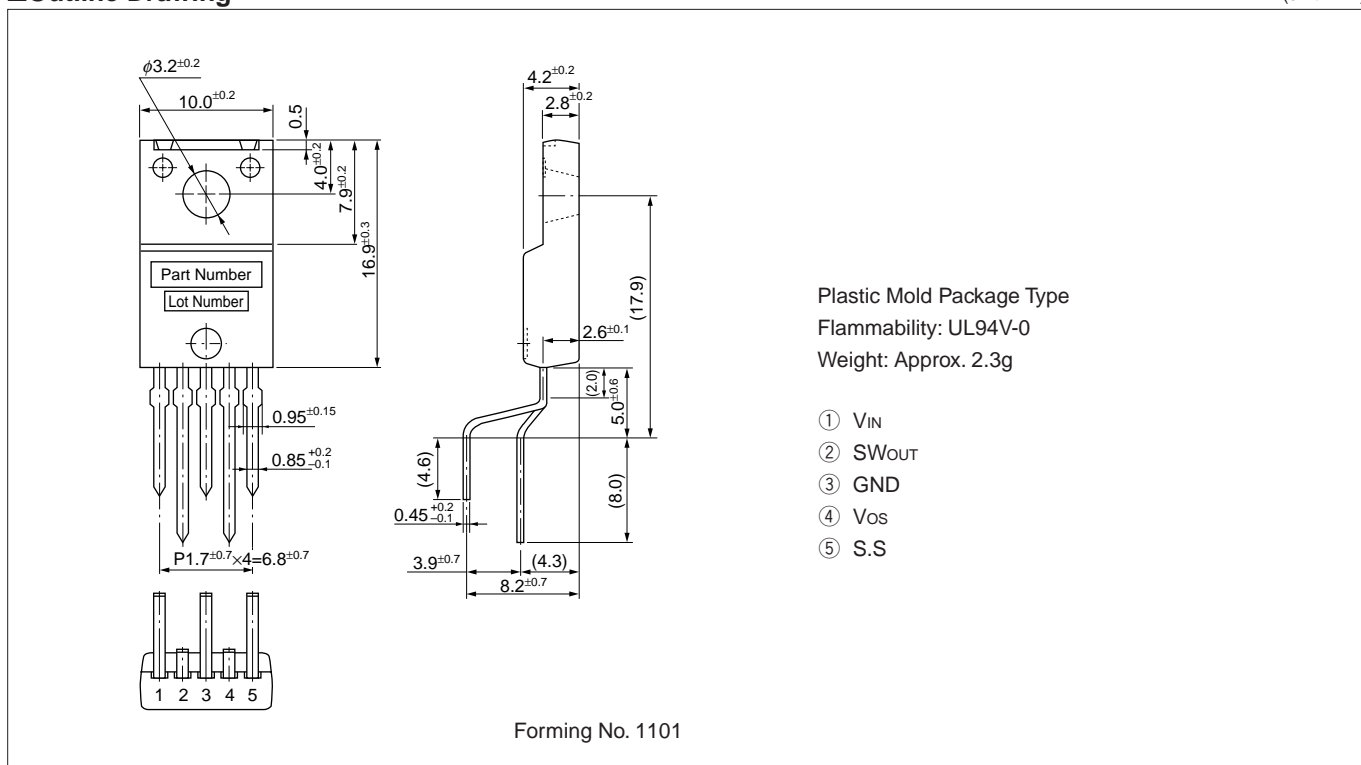

■Block Diagram

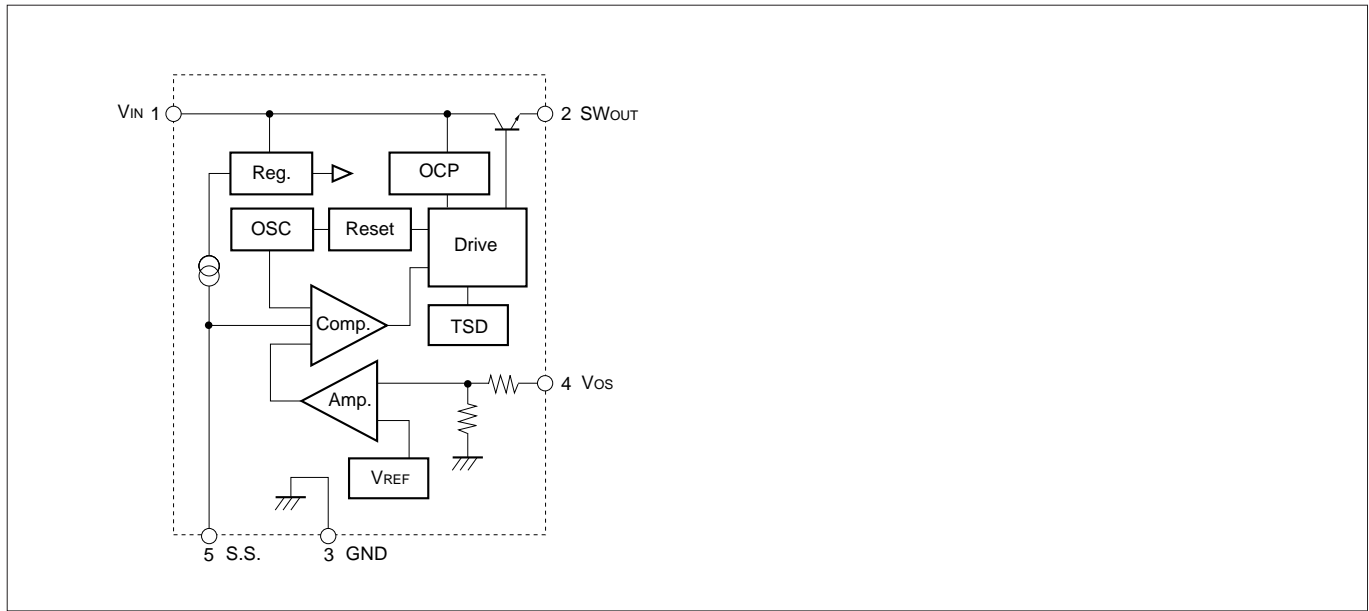

■Standard External Circuit

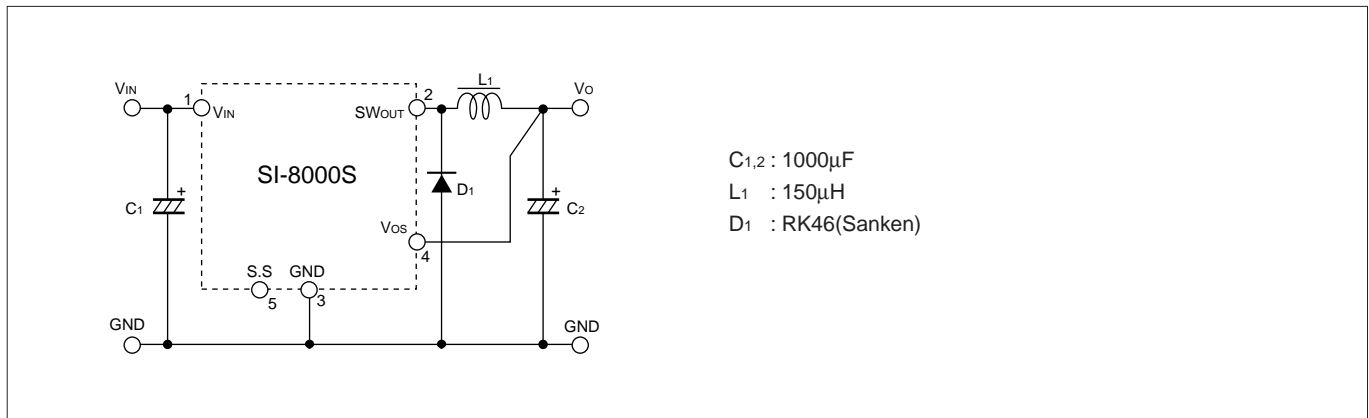

■ T_a - P_D Characteristics

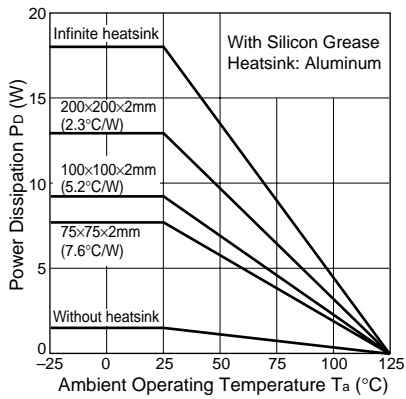

$$P_D = V_O \cdot I_O \left(\frac{100}{\eta \chi} - 1 \right) - V_F \cdot I_O \left(1 - \frac{V_O}{V_{IN}} \right)$$

The efficiency depends on the input voltage and the output current. Thus, obtain the value from the efficiency graph on page 83 and substitute the percentage in the formula above.

- V_O : Output voltage
- V_{IN} : Input voltage
- I_O : Output current
- $\eta \chi$: Efficiency (%)
- V_F : Diode forward voltage
0.5V(RK46)

Thermal design for D₁ must be considered separately.

■Typical Characteristics

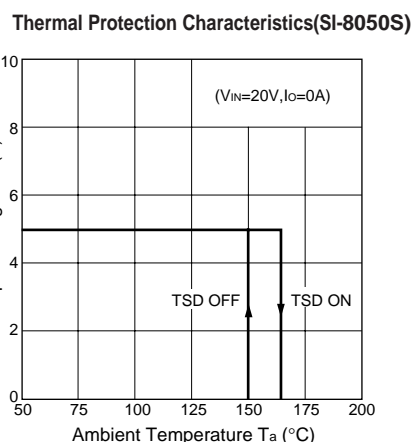
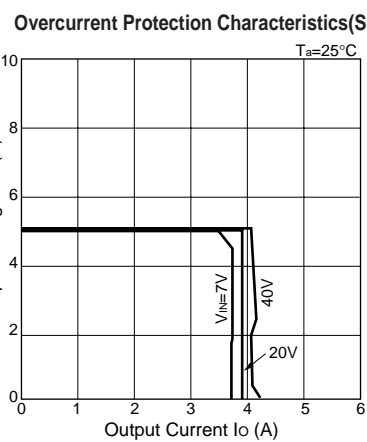
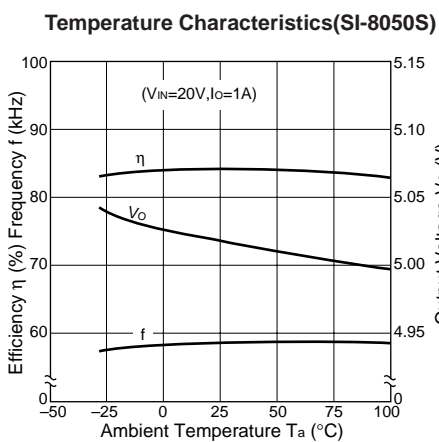
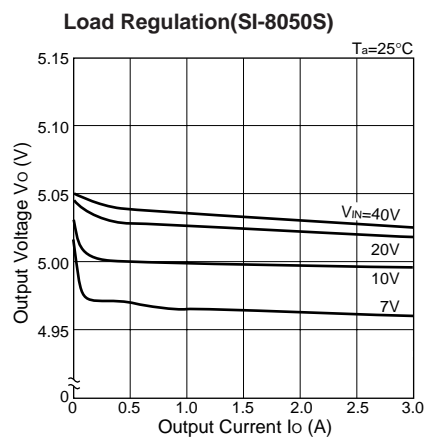
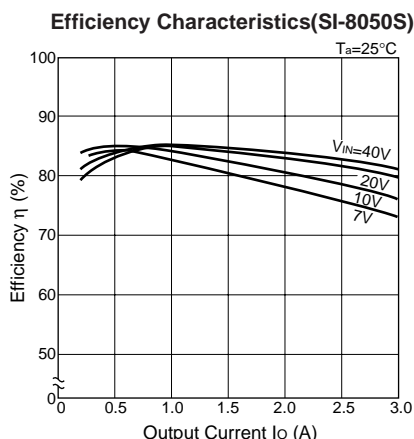
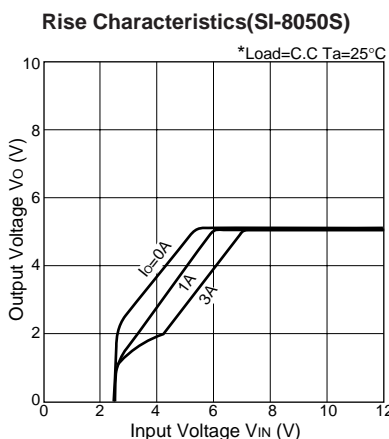

Note on Thermal Protection:

The thermal protection circuit is intended for protection against heat during instantaneous short-circuiting. Its operation is not guaranteed for short-circuiting over extended periods of time.

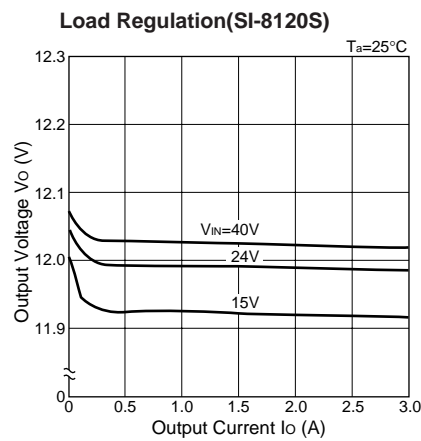
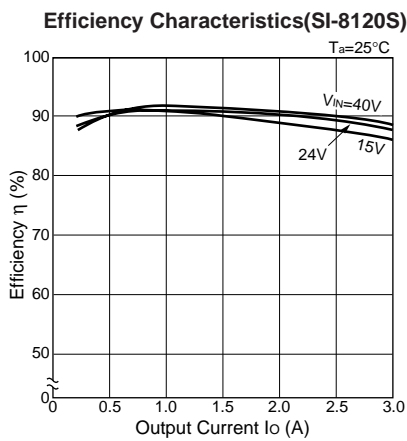
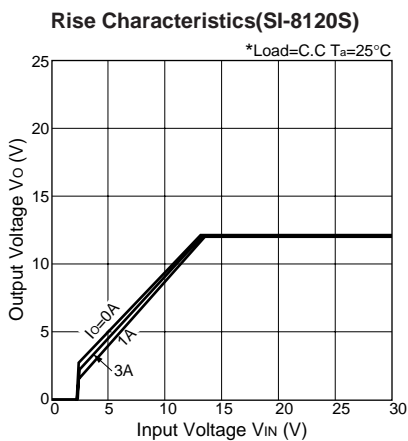

Caution

1. Selecting External Components

(1) Choke coil L₁

To maintain the stable operation of the regulator, choke coil L₁ should be selected appropriately.

When selecting choke coil L₁, consider the following:

- a) Suitable for a switching regulator
Do not use a coil as a noise filter because it generates excess heat.
- b) Appropriate inductance
The greater the inductance of the choke coil, the smaller the output ripple voltage. However, the size of the coil increases large as the inductance increases. If the inductance is low, a greater peak current flows to the IC and loss increases. This is not favorable for stable operation.

The standard external circuit shows reference inductance values suitable for stable operation. However, the appropriate inductance may also be calculated as follows:

$$L = \frac{(V_{IN} - V_O) \cdot V_O}{\Delta I_L \cdot V_{IN} \cdot f}$$

Where, ΔI_L indicates the ripple current of the choke coil that is roughly set as follows:

- If the working output current is close to the maximum rating (3 A) of SI-8000S
Ripple current = output current × 0.2 to 0.3
- If the working output current is about 1.0A or less
Ripple current = output current × 0.3 to 0.4

c) Satisfying the rated current

The rated current of a choke coil must be greater than the maximum load current. Note that the inductance decreases drastically and an excess current flows if the load current exceeds the rated current of the coil.

d) Good DC current superposition characteristics

The current flowing through a choke coil is a triangular waveform current superimposed on a DC current equal to the load current. The coil inductance decreases as the load current increases. In general, the coil can be used until the inductance drops to 50% of the rated value. Use this as the reference value for selection.

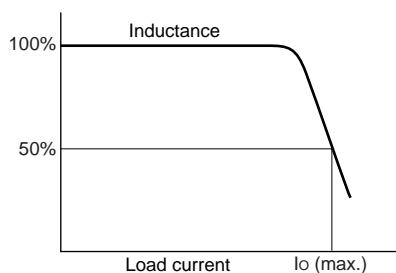

e) Less noise

A drum-type open magnetic core coil can affect peripheral circuits with noise because the flux passes outside the coil. To avoid this problem, use a toroidal, EI, or EE type open magnetic core coil.

(2) Input capacitor C₁

Input capacitor C₁ operates as a bypass capacitor in the input circuit.

When selecting input capacitor C₁, consider the following:

- a) The breakdown voltage is higher than the maximum input voltage.
- b) Satisfies the allowable ripple current
Exceeding the ratings of this capacitor or using it without derating may reduce its service life and also cause the regulator to malfunction. Therefore, an input capacitor with a sufficient margin should be selected. With the SI-8000S Series, the effective ripple current I_{rms} flowing to the input capacitor can be calculated approximately as follows:

$$I_{rms} \approx 1.2 \times \frac{V_O}{V_{IN}} \times I_O$$

(3) Output capacitor C₂

Output capacitor C₂ operates as a smoothing capacitor for switching output. The output ripple voltage from the regulator is determined by the product of the pulsating current part ΔI_L (=C₂ charge-discharge current) of the choke coil current and the equivalent series resistance ESR of the output capacitor C₂.

$$V_{rip} = \Delta I_L \cdot C_2 \cdot ESR$$

Therefore, a capacitor of low equivalent series resistance ESR should be selected to reduce the output ripple voltage. It is recommended to select a low-impedance capacitor intended for use with switching regulators as C₂.

(4) Diode D₁

Use a Schottky barrier diode for D₁. If you use a general rectifier diode or fast recovery diode, the IC may be damaged. (Sanken RK46 recommended)

2. Notes on Pattern Design

(1) Large current line

Since a large current flows through the bold lines in the standard external circuit make the pattern as wide and as short as possible.

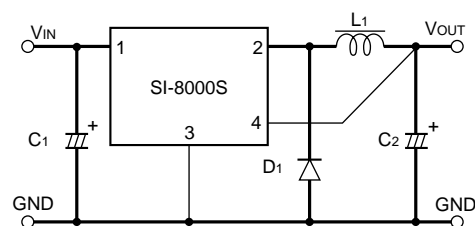

(2) Input capacitor

Place the input capacitor C₁ and output capacitor C₂ as close to the IC as possible. Since a large current flows through the lead wires of the input and output capacitors to charge and discharge them quickly, minimize the lead wire length. The pattern around the capacitors should also be minimized.

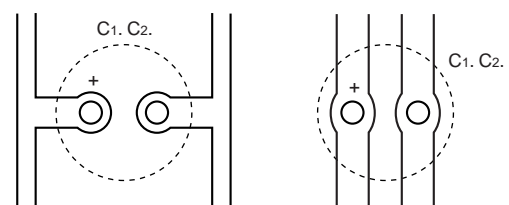

Example of bad pattern

Example of good pattern

(3) Sensing terminal

Output voltage sensing terminal V_{OS} should be connected as close to output capacitor C_2 as possible. If the terminal is far from the capacitor, the decreasing regulation and increasing switching ripple may result in abnormal oscillation.

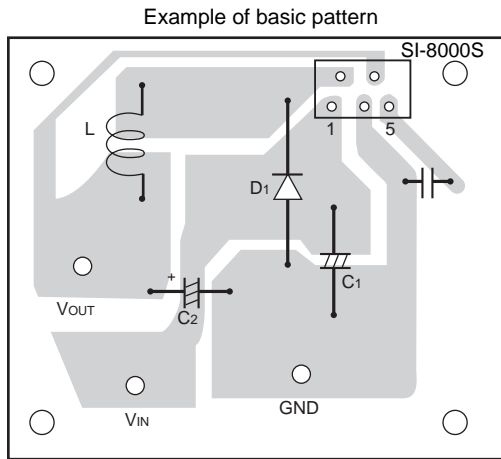

Top view (with part names)

Applications

1. Soft Start

Connecting a capacitor to terminal no. 5 permits a soft start at power-on. Delay time T_d and rise time T_s can roughly be calculated as shown below. (However, the values may slightly vary in an actual application.) If the capacitance of C_3 is increased, it takes longer to discharge C_3 after V_{IN} is turned off. Therefore, it is recommended to set the value within 10 μ F. When not using the soft start function, keep terminal no. 5 open.

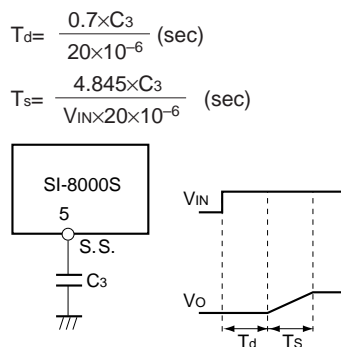

2. Output ON/OFF control

Output can be turned on and off by using the soft start terminals. Set the soft start terminal voltage to V_{SSL} (0.2V typ.) or less to stop output. To switch the potential at the soft start terminals, drive the open collector of the transistor. Since the discharge current from C_3 flows to the ON/OFF control transistor, limit the current for protection. The SS terminal is pulled up to the power supply in the IC and no external voltage can be applied.

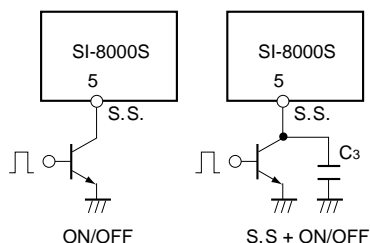

3. Variable Output Voltage

The output voltage can be increased by connecting a resistor to V_{OS} terminal No. 4. (There is no way of decreasing the voltage)

(1) Variable output voltage with single external resistor

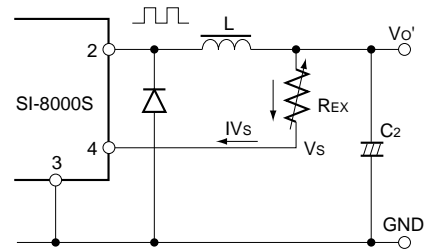

The output voltage adjustment resistance R_{EX} is calculated as follows:

$$R_{EX} = \frac{V_{O'} - V_s}{I_{V_s}}$$

- V_s : Set output voltage of product
- $V_{O'}$: Adjusted output voltage
- I_{V_s} : Inflow current to V_s terminal

* The temperature characteristics of output voltage worsen because the value R_{EX} is not compensated for temperature. The V_s value fluctuates by up to $\pm 20\%$ depending on the IC product. Since the output voltage fluctuates more, a semi-fixed resistor is necessary for accurate output voltage adjustment. If V_s and R_{EX} are constant, the range of output voltage fluctuation can be expressed as follows:

$$\Delta V_{O'}(\%) = \pm 20 \cdot \frac{V_{O'} - V_s}{V_{O'}}$$

$\Delta V_{O'}$: Adjusted output voltage

(2) Variable output voltage with two external resistors

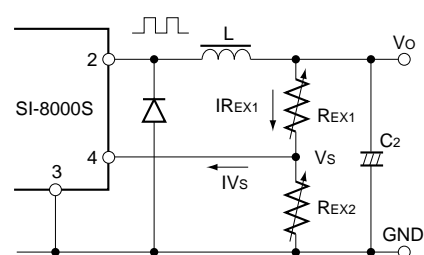

The output voltage adjustment resistances R_{EX1} and R_{EX2} are calculated as follows:

$$R_{EX1} = \frac{V_{O'} - V_s}{S \cdot I_{V_s}}$$

$$R_{EX2} = \frac{V_s}{(S-1) \cdot I_{V_s}}$$

S: Stability factor

Bypassing the current to R_{EX2} improves the temperature characteristics and voltage fluctuation ranges more than the method of (1). Stability factor S indicates the ratio of R_{EX1} to V_s terminal inflow current. Increasing the S value improves the fluctuations of the temperature characteristics and output voltage. (Usually 5 to 10)

If the V_s and R_{EX} values are constant, the output voltage fluctuation range can be calculated as follows:

$$\Delta V_{O'}(\%) = \frac{\pm 20}{S} \cdot \frac{V_{O'} - V_s}{V_{O'}}$$