

SI-8400L/8500L Series

Switching Type — **Separate Excitation Type with Coil**

Features

- Integrated switching IC and coil construction
- Requires only 2 external components
- Low switching noise
- Heatsink not required
- Built-in overcurrent and thermal protection circuits
- Pin compatible with SI-8200L/8300L, providing easy replacement
- Built-in soft start and ON/OFF circuit (8500L Series)

Applications

- For power supplies in telephone sets
- For power supplies in office equipment

Lineup

SI-8400L Series

Type No.	V _O (V)	I _O (A)
SI-8401L	5	0.5
SI-8402L	12	0.4
SI-8403L	3.3	0.5
SI-8404L	13	0.4
SI-8405L	15	0.4
SI-8406L	8	0.4

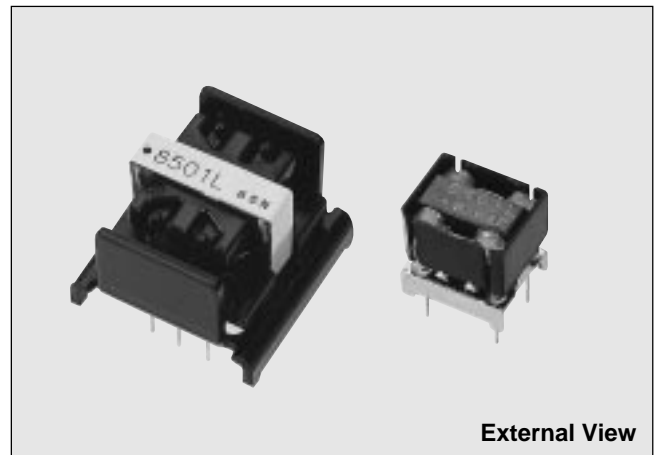

External View

SI-8500L Series

Type No.	V _O (V)	I _O (A)
SI-8501L	5	1
SI-8502L	12	
SI-8503L	3.3	
SI-8504L	9	
SI-8505L	15	

Absolute Maximum Ratings

Parameter	Symbol	Ratings		Unit
		SI-8400L	SL-8500L	
DC Input Voltage Range	V _{IN}	35	35	V
Power Dissipation	P _D	1.25	3	W
Junction Temperature	T _j	+100	+100	°C
Storage Temperature	T _{stg}	-25 to +85	-25 to +85	°C

Recommended Operating Conditions

SI-8400L Series

Parameter	Symbol	Ratings						Unit
		SI-8401L	SL-8402L	SI-8403L	SI-8404L	SI-8405L	SI-8406L	
DC Input Voltage Range	V _{IN}	7 to 33	15 to 33	5.3 to 33	16 to 33	18 to 33	10 to 33	V
Output Current Range	I _o	0 to 0.5	0 to 0.4	0 to 0.5	0 to 0.4	0 to 0.4	0 to 0.4	A
Operating Temperature Range	T _{op}	-20 to +85						°C

SI-8500L Series

Parameter	Symbol	Ratings					Unit
		SI-8501L	SL-8502L	SI-8503L	SI-8504L	SI-8505L	
DC Input Voltage Range	V _{IN}	7 to 33	15 to 33	5.3 to 33	12 to 33	18 to 33	V
Output Current Range	I _o	0 to 1					A
Operating Temperature Range	T _{op}	-20 to +85					°C

SI-8400L/8500L Series

■ Electrical Characteristics (Ta=25°C)

Parameter	Symbol	Ratings																		Unit
		SI-8400L Series																		
		SI-8401L			SI-8402L			SI-8403L			SI-8404L			SI-8405L			SI-8406L			
min	typ	max	min	typ	max	min	typ	max	min	typ	max	min	typ	max	min	typ	max			
Output Voltage	V _O	4.80	5.00	5.20	11.40	12.00	12.60	3.17	3.30	3.43	12.35	13.00	13.65	14.25	15.00	15.75	7.60	8.00	8.40	V
	Condition	V _{IN} =20V, I _O =0.3A			V _{IN} =24V, I _O =0.3A			V _{IN} =15V, I _O =0.3A			V _{IN} =25V, I _O =0.3A			V _{IN} =27V, I _O =0.3A			V _{IN} =20V, I _O =0.3A			
Efficiency	η		80			88			75			88			89			85		%
	Condition	V _{IN} =20V, I _O =0.3A			V _{IN} =24V, I _O =0.3A			V _{IN} =15V, I _O =0.3A			V _{IN} =25V, I _O =0.3A			V _{IN} =27V, I _O =0.3A			V _{IN} =20V, I _O =0.3A			
Switching Frequency	f		60			60			60			60			60			60		kHz
	Condition	V _{IN} =20V, I _O =0.3A			V _{IN} =24V, I _O =0.3A			V _{IN} =15V, I _O =0.3A			V _{IN} =25V, I _O =0.3A			V _{IN} =27V, I _O =0.3A			V _{IN} =20V, I _O =0.3A			
Line Regulation	ΔV _{OLINE}		80	100		100	130		60	80		100	130		100	130		85	105	mV
	Condition	V _{IN} =10 to 30V, I _O =0.3A			V _{IN} =18 to 30V, I _O =0.3A			V _{IN} =8 to 30V, I _O =0.3A			V _{IN} =19 to 30V, I _O =0.3A			V _{IN} =21 to 30V, I _O =0.3A			V _{IN} =13 to 30V, I _O =0.3A			
Load Regulation	ΔV _{OLOAD}		30	40		70	95		20	30		75	100		90	120		40	70	mV
	Condition	V _{IN} =20V, I _O =0.1 to 0.4A			V _{IN} =24V, I _O =0.1 to 0.4A			V _{IN} =15V, I _O =0.1 to 0.4A			V _{IN} =25V, I _O =0.1 to 0.4A			V _{IN} =25V, I _O =0.1 to 0.4A			V _{IN} =21V, I _O =0.1 to 0.4A			
Temperature Coefficient of Output Voltage	ΔV _O /ΔT		±0.5			±1.5			±0.5			±1.5			±1.5			±1.0		mV/°C
Switching Ripple Voltage (C ₂ =470μF)	ΔV _r		20	40		35	70		15	30		30	60		40	80		25	50	mVp-p
	Condition	V _{IN} =20V, I _O =0.3A			V _{IN} =24V, I _O =0.3A			V _{IN} =15V, I _O =0.3A			V _{IN} =25V, I _O =0.3A			V _{IN} =27V, I _O =0.3A			V _{IN} =20V, I _O =0.3A			
Overcurrent Protection Starting Current	I _s	0.55			0.45			0.55			0.45			0.45			0.45			A
	Condition	V _{IN} =10V			V _{IN} =18V			V _{IN} =8V			V _{IN} =19V			V _{IN} =21V			V _{IN} =20V			

Parameter	Symbol	Ratings																		Unit
		SI-8500L Series																		
		SI-8501L			SI-8502L			SI-8503L			SI-8504L			SI-8505L						
min	typ	max	min	typ	max	min	typ	max	min	typ	max	min	typ	max	min	typ	max			
Output Voltage	V _O	4.80	5.00	5.20	11.40	12.00	12.60	3.17	3.30	3.43	8.55	9.00	9.45	14.25	15.00	15.75				V
	Condition	V _{IN} =20V, I _O =0.5A			V _{IN} =24V, I _O =0.5A			V _{IN} =15V, I _O =0.5A			V _{IN} =21V, I _O =0.5A			V _{IN} =25V, I _O =0.5A						
Efficiency	η		83			89			79			87			90					%
	Condition	V _{IN} =20V, I _O =0.5A			V _{IN} =24V, I _O =0.5A			V _{IN} =15V, I _O =0.5A			V _{IN} =21V, I _O =0.5A			V _{IN} =25V, I _O =0.5A						
Switching Frequency	f		60			60			60			60			60					kHz
	Condition	V _{IN} =20V, I _O =0.5A			V _{IN} =24V, I _O =0.5A			V _{IN} =15V, I _O =0.5A			V _{IN} =21V, I _O =0.5A			V _{IN} =25V, I _O =0.5A						
Line Regulation	ΔV _{OLINE}		70	130		70	130		50	80		70	130		70	130				mV
	Condition	V _{IN} =10 to 30V, I _O =0.5A			V _{IN} =18 to 30V, I _O =0.5A			V _{IN} =8 to 30V, I _O =0.5A			V _{IN} =15 to 30V, I _O =0.5A			V _{IN} =21 to 30V, I _O =0.5A						
Load Regulation	ΔV _{OLOAD}		30	55		30	55		20	45		30	55		30	55				mV
	Condition	V _{IN} =20V, I _O =0.2 to 0.8A			V _{IN} =24V, I _O =0.2 to 0.8A			V _{IN} =15V, I _O =0.2 to 0.8A			V _{IN} =21V, I _O =0.2 to 0.8A			V _{IN} =21V, I _O =0.2 to 0.8A						
Temperature Coefficient of Output Voltage	ΔV _O /ΔT		±0.5			±1.5			±0.5			±1.0			±1.5					mV/°C
Switching Ripple Voltage (C ₂ =470μF)	ΔV _r		45			30			15			25			30					mVp-p
	Condition	V _{IN} =20V, I _O =0.5A			V _{IN} =24V, I _O =0.5A			V _{IN} =15V, I _O =0.5A			V _{IN} =21V, I _O =0.5A			V _{IN} =25V, I _O =0.5A						
Overcurrent Protection Starting Current	I _s	1.1			1.1			1.1			1.1			1.1			1.1			A
	Condition	V _{IN} =18V			V _{IN} =24V			V _{IN} =12V			V _{IN} =21V			V _{IN} =25V						

Outline Drawing (unit: mm)

SI-8400L

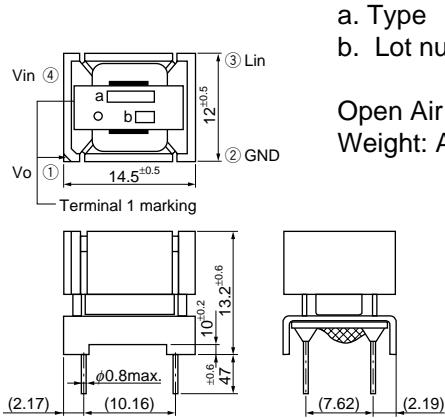

SI-8500L

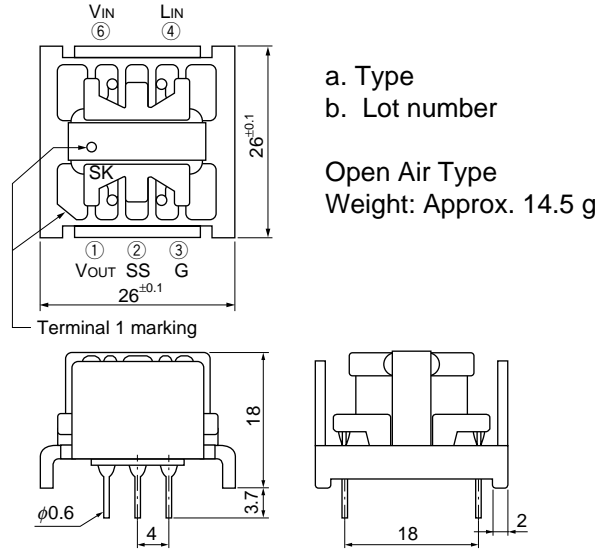

Standard External Circuit

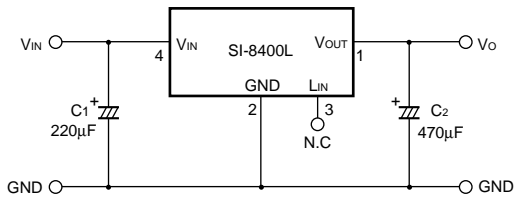

Pin compatible with SI-8200L

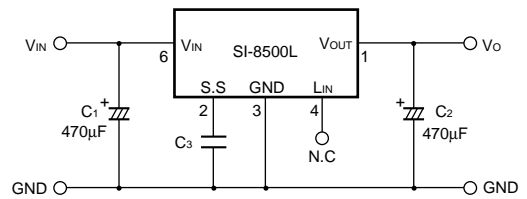

C₃ is necessary only for using soft start function.
Pin compatible with SI-8300L

Block Diagram

SI-8400L

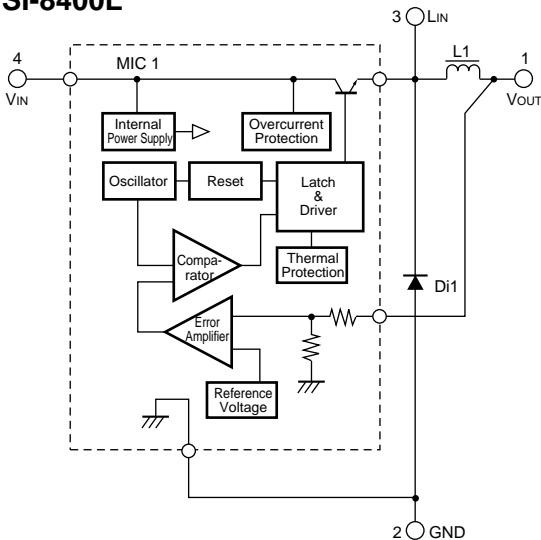

SI-8500L

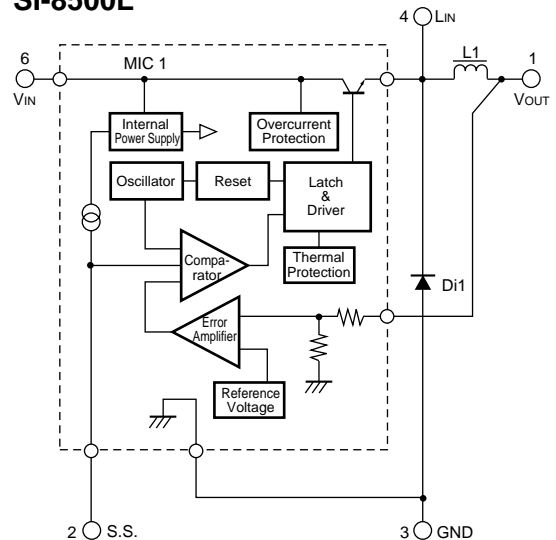

SI-8400L/8500L Series

■ Ta-PD Characteristics

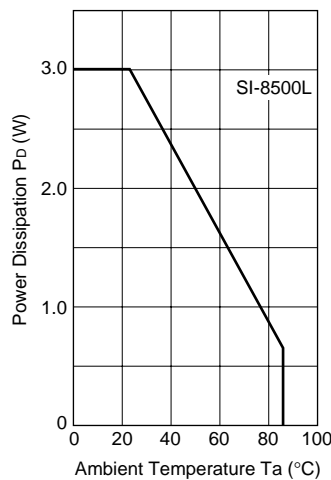
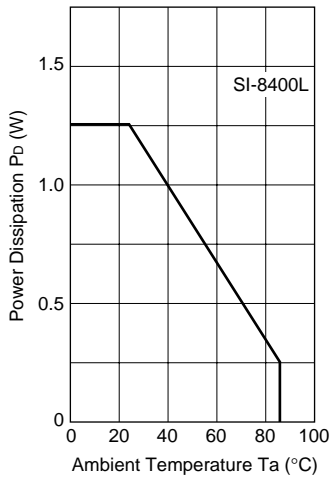

$$P_D = V_O \cdot I_O \left(\frac{100}{\eta\%} - 1 \right)$$

V_O : Output voltage

I_O : Output current

$\eta\%$: Efficiency

Note: The efficiency depends on the input voltage and the output current. Thus, obtain the value from the efficiency graph and substitute the percentage in the formula above.

■ SI-8500L Application Circuit

V_O .ON/OFF operation can be performed with an open collector driver using a transistor. Soft start can also be performed by connecting a capacitor.

Voltage cannot be applied to soft start terminal externally. When not using the soft start terminal, it must be left open. It is pulled up inside the IC.

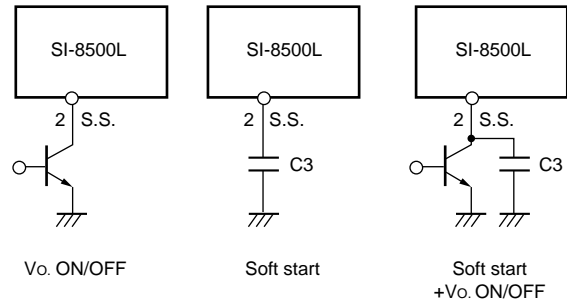

■ Caution

1. Allocation of Components

For the best operating environment, the ground should be a single ground line at the GND pin (pin 2 on the SI-8400L, pin 3 on the SI-8500L), and the wiring from C₁ and C₂ to ground should be as short as possible.

2. Capacitors C₁ and C₂

- ① They must satisfy the breakdown voltage and allowable ripple current. Use of these capacitors over their derating values shortens their service lives and may also cause abnormal oscillation of the IC.
- ② C₂ must be a low-impedance type capacitor. A low-impedance type capacitor is recommended for C₂ to ensure minimum ripple voltage and stable switching operation.
- ③ C₃ (SI-8500L only) is a capacitor for soft start. When not using soft start, leave pin 2 open. It is pulled up inside the IC.

3. Terminals L_{IN} and NC in the connection diagram must be left unconnected to other circuits.

4. The IC's metallic heatsink is electrically floating. Do not connect it to GND or any other circuit.

5. Since the SI-8400L and 8500L series have an open-package construction, they can only be operated in specific environments. Verify the operating environment and use the IC within the conditions indicated in the reliability data.

SI-8400L/SI-8500L Series Typical Operating Characteristics

Rise Characteristics (SI-8401L)

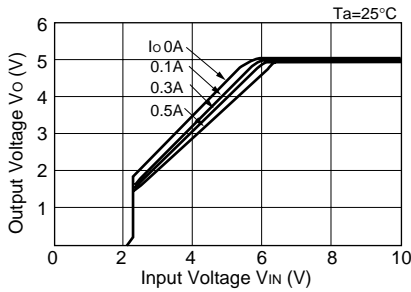

Efficiency Characteristics (SI-8401L)

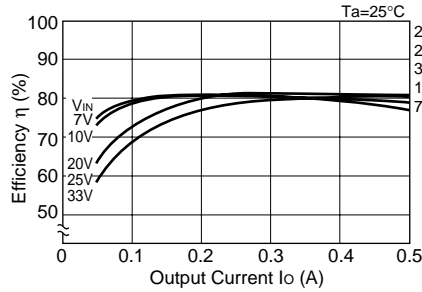

Load Regulation (SI-8401L)

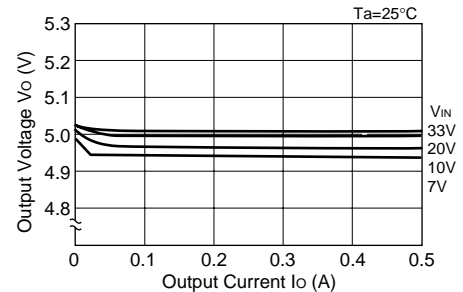

Temperature Characteristics (SI-8401L)

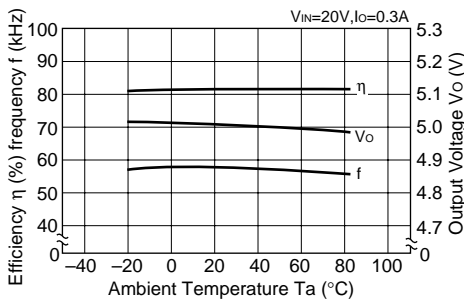

Overcurrent Protection Characteristics (SI-8401L)

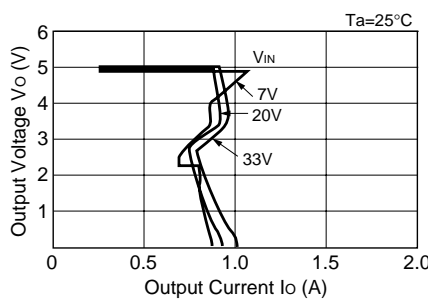

Thermal Protection Characteristics (SI-8401L)

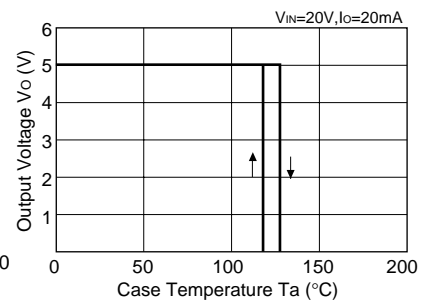

Note on Thermal Protection Characteristics:

The thermal protection circuit is intended for protection against heat during instantaneous short-circuiting. Its operation is not guaranteed for short-circuiting over extended periods of time.

Rise Characteristics (SI-8402L)

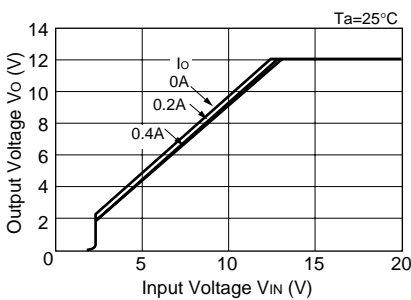

Efficiency Characteristics (SI-8402L)

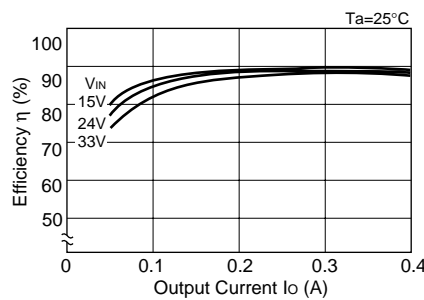

Load Regulation (SI-8402L)

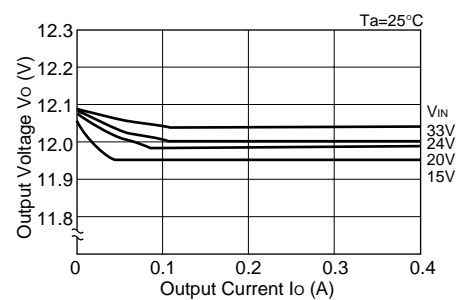

SI-8400L/8500L Series

SI-8400L/SI-8500L Series Typical Operating Characteristics

Rise Characteristics (SI-8501L)

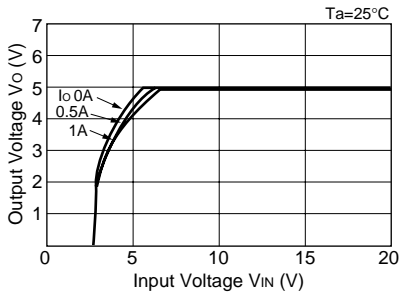

Efficiency Characteristics (SI-8501L)

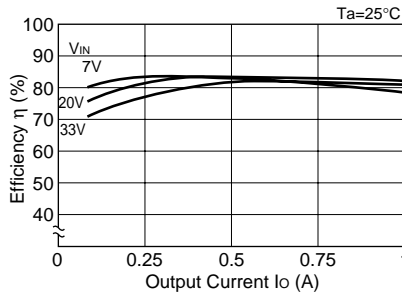

Load Regulation (SI-8501L)

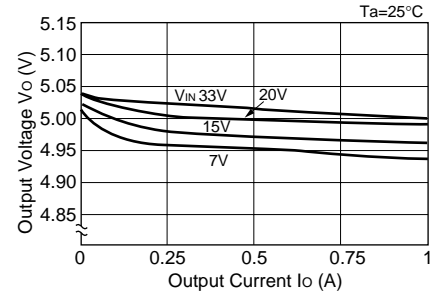

Temperature Characteristics (SI-8501L)

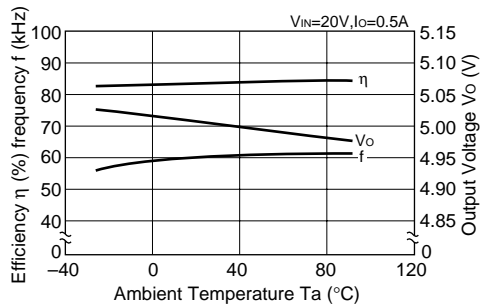

Overcurrent Protection Characteristics (SI-8501L)

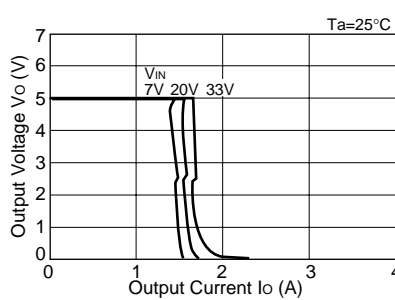

Thermal Protection Characteristics (SI-8501L)

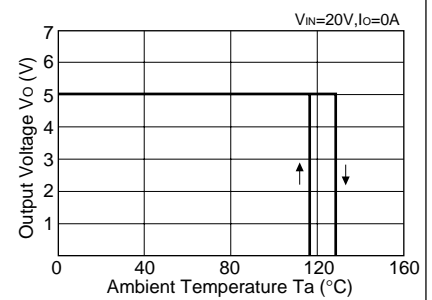

Note on Thermal Protection Characteristics:

The thermal protection circuit is intended for protection against heat during instantaneous short-circuiting. Its operation is not guaranteed for short-circuiting over extended periods of time.

Rise Characteristics (SI-8502L)

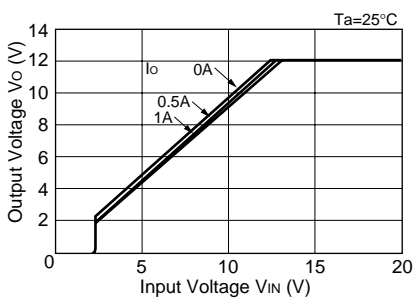

Efficiency Characteristics (SI-8502L)

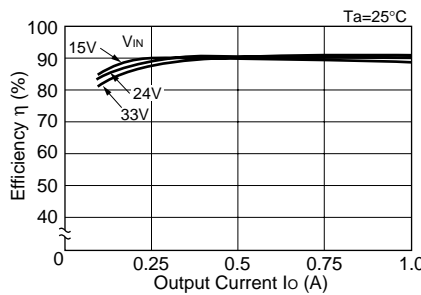

Load Regulation (SI-8502L)

