

## SI-8400L/8500L Series

# Separate Excitation Switching Type with Coil

### ■Features

- Integrated switching IC and coil construction
- Requires 2 external components only
- Low switching noise
- Heatsink not required
- Built-in overcurrent and thermal protection circuits
- Built-in soft start circuit (Output ON/OFF control)...SI-8500L Series

### ■Applications

- Telephone power supplies
- Onboard local power supplies



### ■Lineup

| Part Number        | SI-8401L | SI-8402L | SI-8403L | SI-8405L | SI-8501L | SI-8502L | SI-8503L | SI-8504L | SI-8505L |
|--------------------|----------|----------|----------|----------|----------|----------|----------|----------|----------|
| V <sub>o</sub> (V) | 5.0      | 12.0     | 3.3      | 15.0     | 5.0      | 12.0     | 3.3      | 9.0      | 15.0     |
| I <sub>o</sub> (A) | 0.5      | 0.4      | 0.5      | 0.4      | 1.0      |          |          |          |          |

### ■Absolute Maximum Ratings

| Parameter            | Symbol           | Ratings    |          | Unit |
|----------------------|------------------|------------|----------|------|
|                      |                  | SI-8400L   | SI-8500L |      |
| DC Input Voltage     | V <sub>IN</sub>  | 35         |          | V    |
| Power Dissipation    | P <sub>D</sub>   | 1.25       | 3        | W    |
| Junction Temperature | T <sub>j</sub>   | +100       |          | °C   |
| Storage Temperature  | T <sub>stg</sub> | -25 to +85 |          | °C   |

### ■Recommended Operating Conditions

| Parameter                   | Symbol          | Ratings    |          |           |          | Unit |
|-----------------------------|-----------------|------------|----------|-----------|----------|------|
|                             |                 | SI-8401L   | SI-8402L | SI-8403L  | SI-8405L |      |
| DC Input Voltage Range      | V <sub>IN</sub> | 7 to 33    | 15 to 33 | 5.3 to 33 | 18 to 33 | V    |
| Output Current Range        | I <sub>o</sub>  | 0 to 0.5   | 0 to 0.4 | 0 to 0.5  | 0 to 0.4 | A    |
| Operating Temperature Range | T <sub>op</sub> | -20 to +85 |          |           |          | °C   |

| Parameter                   | Symbol          | Ratings    |          |           |          |          | Unit |
|-----------------------------|-----------------|------------|----------|-----------|----------|----------|------|
|                             |                 | SI-8501L   | SI-8502L | SI-8503L  | SI-8504L | SI-8505L |      |
| DC Input Voltage Range      | V <sub>IN</sub> | 7 to 33    | 15 to 33 | 5.3 to 33 | 12 to 33 | 18 to 33 | V    |
| Output Current Range        | I <sub>o</sub>  | 0 to 1.0   |          |           |          |          | A    |
| Operating Temperature Range | T <sub>op</sub> | -20 to +85 |          |           |          |          | °C   |

■Electrical Characteristics

(Ta=25°C)

| Parameter                                 | Symbol              | Ratings                 |      |      |                         |       |       |                         |      |      |                         |       |       | Unit              |
|---|---------------------|-------------------------|------|------|-------------------------|-------|-------|-------------------------|------|------|-------------------------|-------|-------|-------------------|
|   |                     | SI-8401L                |      |      | SI-8402L                |       |       | SI-8403L                |      |      | SI-8405L                |       |       |                   |
|   |                     | min.                    | typ. | max. | min.                    | typ.  | max.  | min.                    | typ. | max. | min.                    | typ.  | max.  |                   |
| Output Voltage                            | Vo                  | 4.80                    | 5.00 | 5.20 | 11.40                   | 12.00 | 12.60 | 3.17                    | 3.30 | 3.43 | 14.25                   | 15.00 | 15.75 | V                 |
|   | Conditions          | VIN=20V, Io=0.3A        |      |      | VIN=24V, Io=0.3A        |       |       | VIN=15V, Io=0.3A        |      |      | VIN=27V, Io=0.3A        |       |       |                   |
| Efficiency                                | η                   |                         | 80   |      |                         | 88    |       |                         | 75   |      |                         | 89    |       | %                 |
|   | Conditions          | VIN=20V, Io=0.3A        |      |      | VIN=24V, Io=0.3A        |       |       | VIN=15V, Io=0.3A        |      |      | VIN=27V, Io=0.3A        |       |       |                   |
| Switching Frequency                       | f                   |                         | 60   |      |                         | 60    |       |                         | 60   |      |                         | 60    |       | kHz               |
|   | Conditions          | VIN=20V, Io=0.3A        |      |      | VIN=24V, Io=0.3A        |       |       | VIN=15V, Io=0.3A        |      |      | VIN=27V, Io=0.3A        |       |       |                   |
| Line Regulation                           | ΔV <sub>OLINE</sub> |                         | 80   | 100  |                         | 100   | 130   |                         | 60   | 80   |                         | 100   | 130   | mV                |
|   | Conditions          | VIN=10 to 30V, Io=0.3A  |      |      | VIN=18 to 30V, Io=0.3A  |       |       | VIN=8 to 30V, Io=0.3A   |      |      | VIN=21 to 30V, Io=0.3A  |       |       |                   |
| Load Regulation                           | ΔV <sub>OLOAD</sub> |                         | 30   | 40   |                         | 70    | 95    |                         | 20   | 30   |                         | 90    | 120   | mV                |
|   | Conditions          | VIN=20V, Io=0.1 to 0.4A |      |      | VIN=24V, Io=0.1 to 0.4A |       |       | VIN=15V, Io=0.1 to 0.4A |      |      | VIN=27V, Io=0.1 to 0.4A |       |       |                   |
| Temperature Coefficient of Output Voltage | ΔVo/ΔTa             |                         | ±0.5 |      |                         | ±1.5  |       |                         | ±0.5 |      |                         | ±1.5  |       | mV/°C             |
| Switching Ripple Voltage (C2=470μF)       | ΔV <sub>r</sub>     |                         | 20   | 40   |                         | 35    | 70    |                         | 15   | 30   |                         | 40    | 80    | mV <sub>p-p</sub> |
|   | Conditions          | VIN=20V, Io=0.3A        |      |      | VIN=24V, Io=0.3A        |       |       | VIN=15V, Io=0.3A        |      |      | VIN=27V, Io=0.3A        |       |       |                   |
| Overcurrent Protection Starting Current   | Is1                 | 0.55                    |      |      | 0.45                    |       |       | 0.55                    |      |      | 0.45                    |       |       | A                 |
|   | Conditions          | VIN=10V                 |      |      | VIN=18V                 |       |       | VIN=8V                  |      |      | VIN=21V                 |       |       |                   |

(Ta=25°C)

| Parameter                                 | Symbol              | Ratings                 |      |      |                         |       |       |                         |      |      |                         |      |      | Unit                    |          |                   |      |
|---|---------------------|-------------------------|------|------|-------------------------|-------|-------|-------------------------|------|------|-------------------------|------|------|-------------------------|----------|-------------------|------|
|   |                     | SI-8501L                |      |      | SI-8502L                |       |       | SI-8503L                |      |      | SI-8504L                |      |      |                         | SI-8505L |                   |      |
|   |                     | min.                    | typ. | max. | min.                    | typ.  | max.  | min.                    | typ. | max. | min.                    | typ. | max. |                         | min.     | typ.              | max. |
| Output Voltage                            | Vo                  | 4.80                    | 5.00 | 5.20 | 11.40                   | 12.00 | 12.60 | 3.17                    | 3.30 | 3.43 | 8.55                    | 9.00 | 9.45 | 14.25                   | 15.00    | 15.75             | V    |
|   | Conditions          | VIN=20V, Io=0.5A        |      |      | VIN=24V, Io=0.5A        |       |       | VIN=15V, Io=0.5A        |      |      | VIN=21V, Io=0.5A        |      |      | VIN=25V, Io=0.5A        |          |                   |      |
| Efficiency                                | η                   |                         | 83   |      |                         | 89    |       |                         | 79   |      |                         | 87   |      | 90                      |          | %                 |      |
|   | Conditions          | VIN=20V, Io=0.5A        |      |      | VIN=24V, Io=0.5A        |       |       | VIN=15V, Io=0.5A        |      |      | VIN=21V, Io=0.5A        |      |      | VIN=25V, Io=0.5A        |          |                   |      |
| Switching Frequency                       | f                   |                         | 60   |      |                         | 60    |       |                         | 60   |      |                         | 60   |      | 60                      |          | kHz               |      |
|   | Conditions          | VIN=20V, Io=0.5A        |      |      | VIN=24V, Io=0.5A        |       |       | VIN=15V, Io=0.5A        |      |      | VIN=21V, Io=0.5A        |      |      | VIN=25V, Io=0.5A        |          |                   |      |
| Line Regulation                           | ΔV <sub>OLINE</sub> |                         | 70   | 130  |                         | 70    | 130   |                         | 50   | 80   |                         | 70   | 130  |                         | 70       | 130               | mV   |
|   | Conditions          | VIN=10 to 30V, Io=0.5A  |      |      | VIN=18 to 30V, Io=0.5A  |       |       | VIN=8 to 30V, Io=0.5A   |      |      | VIN=15 to 30V, Io=0.5A  |      |      | VIN=21 to 30V, Io=0.5A  |          |                   |      |
| Load Regulation                           | ΔV <sub>OLOAD</sub> |                         | 30   | 55   |                         | 30    | 55    |                         | 20   | 45   |                         | 30   | 55   |                         | 30       | 55                | mV   |
|   | Conditions          | VIN=20V, Io=0.2 to 0.8A |      |      | VIN=24V, Io=0.2 to 0.8A |       |       | VIN=15V, Io=0.2 to 0.8A |      |      | VIN=21V, Io=0.2 to 0.8A |      |      | VIN=25V, Io=0.2 to 0.8A |          |                   |      |
| Temperature Coefficient of Output Voltage | ΔVo/ΔTa             |                         | ±0.5 |      |                         | ±1.5  |       |                         | ±0.5 |      |                         | ±1.0 |      | ±1.5                    |          | mV/°C             |      |
| Switching Ripple Voltage (C2=470μF)       | ΔV <sub>r</sub>     |                         | 45   |      |                         | 30    |       |                         | 15   |      |                         | 25   |      | 30                      |          | mV <sub>p-p</sub> |      |
|   | Conditions          | VIN=20V, Io=0.5A        |      |      | VIN=24V, Io=0.5A        |       |       | VIN=15V, Io=0.5A        |      |      | VIN=21V, Io=0.5A        |      |      | VIN=25V, Io=0.5A        |          |                   |      |
| Overcurrent Protection Starting Current   | Is1                 | 1.1                     |      |      | 1.1                     |       |       | 1.1                     |      |      | 1.1                     |      |      | 1.1                     |          | A                 |      |
|   | Conditions          | VIN=18V                 |      |      | VIN=24V                 |       |       | VIN=12V                 |      |      | VIN=21V                 |      |      | VIN=25V                 |          |                   |      |

■Outline Drawing

(unit:mm)

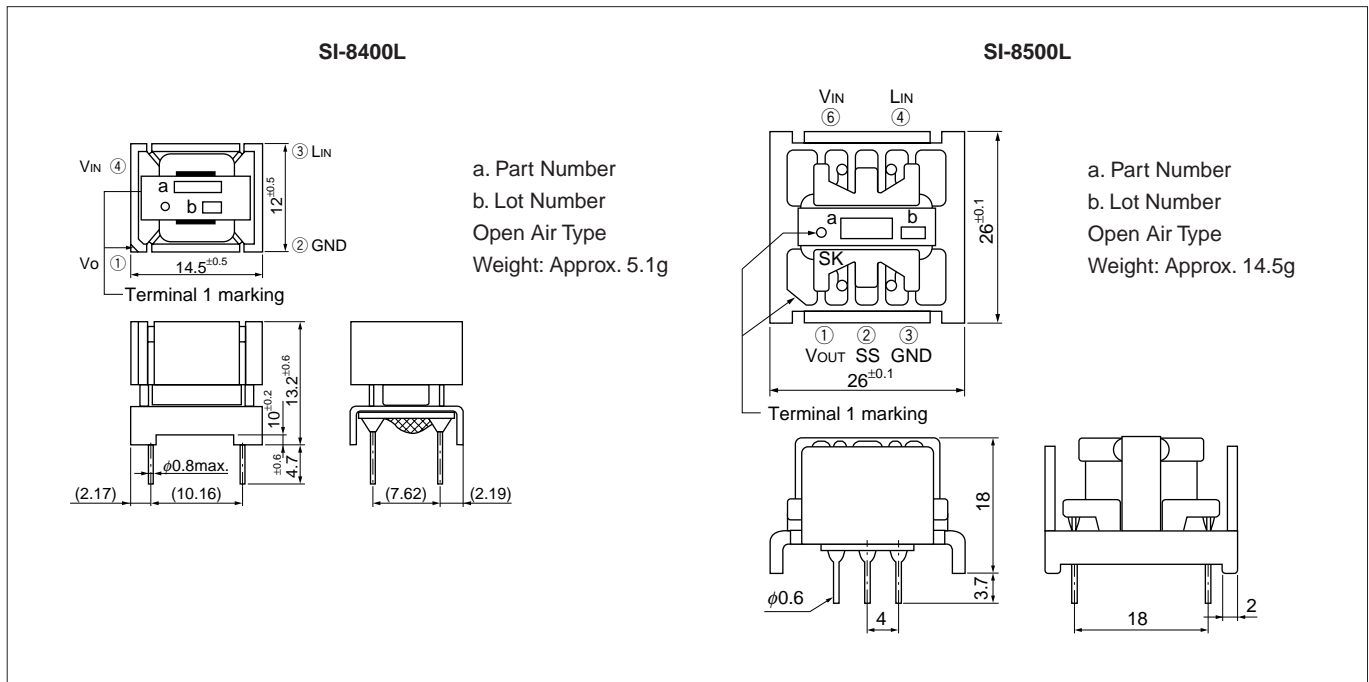

■Block Diagram

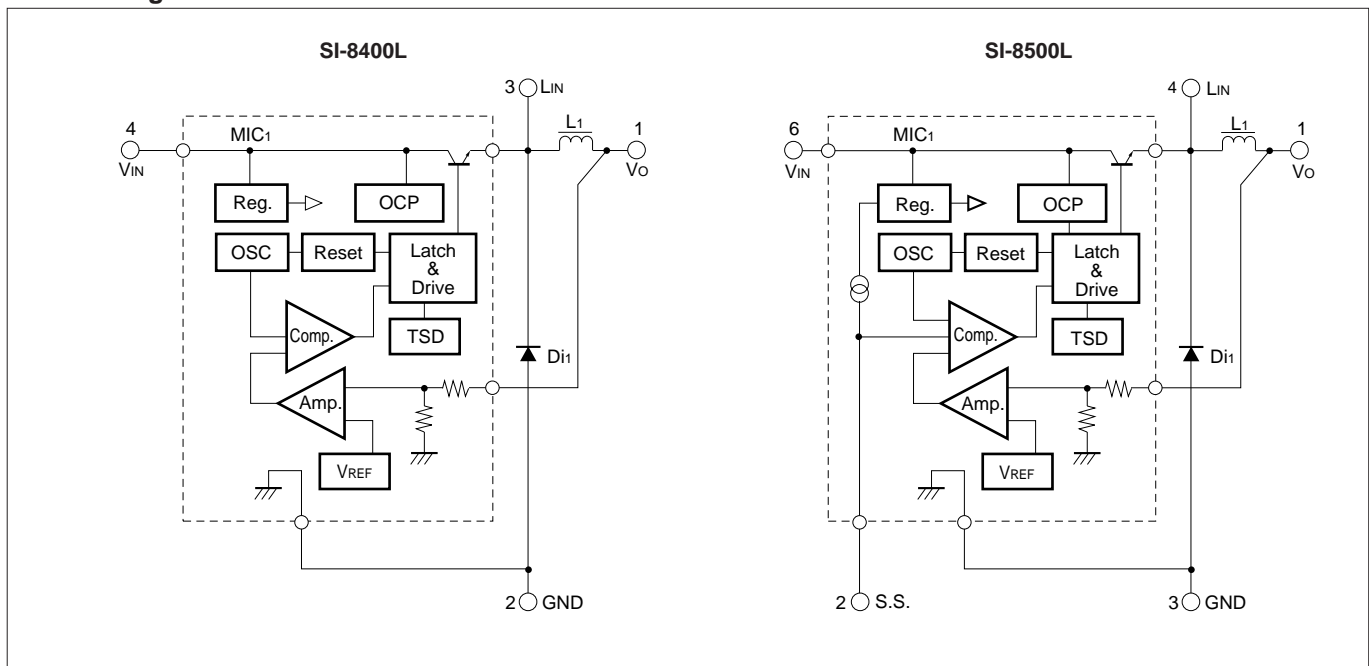

■Standard External Circuit

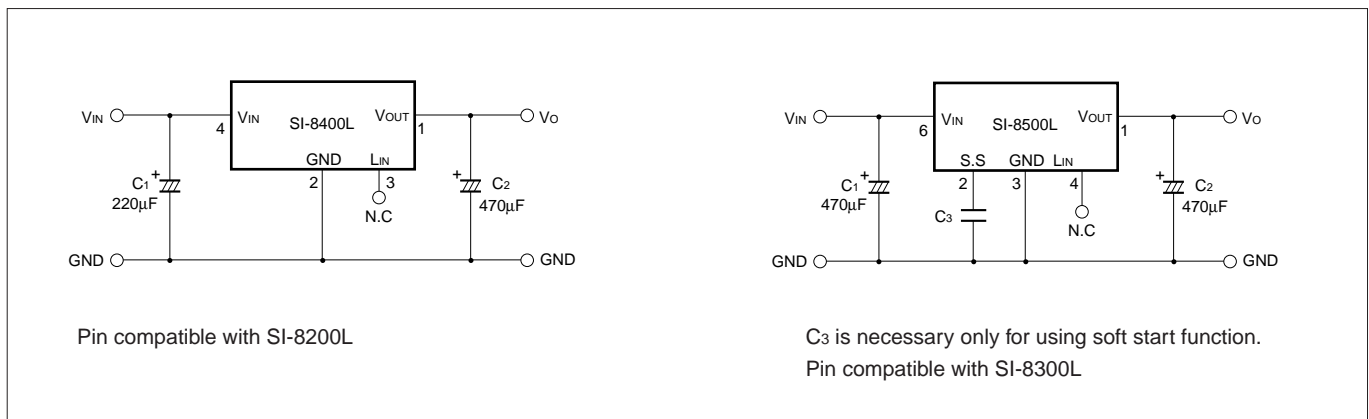

■**T<sub>a</sub>-P<sub>D</sub> Characteristics**

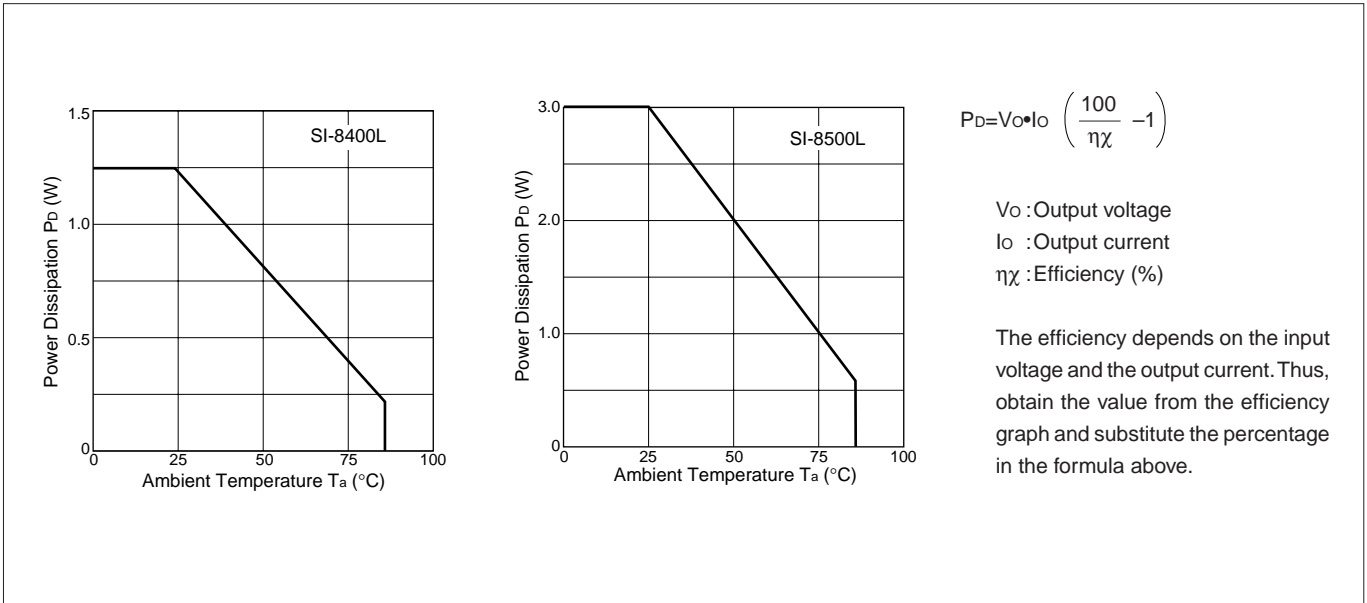

■**SI-8500L application circuit**

Terminal no.2 is for soft start. Connecting a capacitor to the terminal enables the soft start function. See page 85 for the formulas to calculate delay time and rise time. Output can be turned on and off by using the soft start terminal. To stop output, set the soft start terminal voltage to V<sub>SSL</sub> (0.2V typ.) or less. To switch the potential of the soft start terminal, drive the open collector of the transistor. Since the discharge current from C<sub>3</sub> flows to the ON/OFF control transistor, limit the current for protection. The SS terminal is pulled up to the power supply in the IC and no external voltage can be applied.

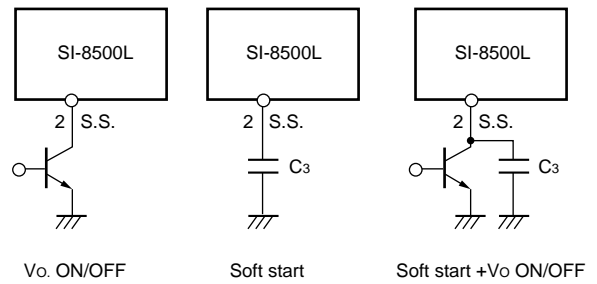

■**Caution**

1. Allocation of Components

For the best operating environment, the ground should be a single ground line at the GND terminal (terminal 2 on the SI-8400L, terminal 3 on the SI-8500L), and the wiring from C<sub>1</sub> and C<sub>2</sub> to ground should be as short as possible.

2. Capacitors C<sub>1</sub> and C<sub>2</sub>

1) They must satisfy the breakdown voltage and allowable ripple current.

Exceeding the ratings of these capacitors or using them without derating shortens their service lives and may also cause abnormal oscillation of the IC.

2) C<sub>2</sub> must be a low-impedance type capacitor to ensure minimum ripple voltage and stable switching operation.

3) C<sub>3</sub> (SI-8500L only) is a capacitor for soft start. When not using soft start, leave terminal 2 open. It is pulled up inside the IC.

3. Terminals LIN and NC in the connection diagram must be left unconnected to other circuits.

4. The IC's metallic heatsink is electrically floating. Do not connect it to GND or any other circuit.

5. Since the SI-8400L and 8500L series have an open-package construction, they can only be operated in specific environments. Verify the operating environment and use the conditions indicated in the reliability data.

■Typical Characteristics (SI-8400L Series)

Rise Characteristics(SI-8401L)

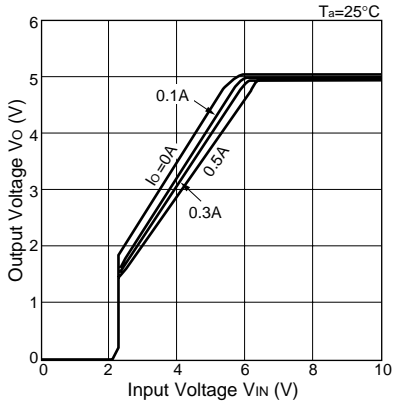

Efficiency Characteristics(SI-8401L)

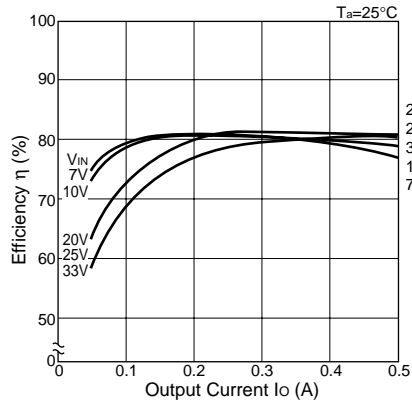

Load Regulation(SI-8401L)

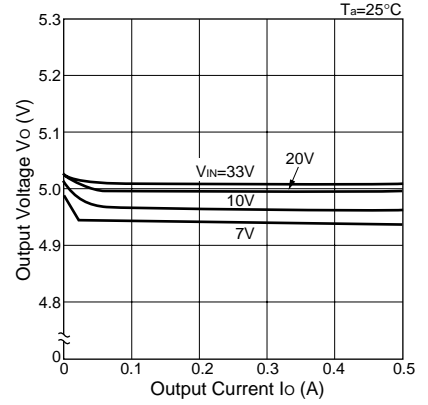

Temperature Characteristics(SI-8401L)

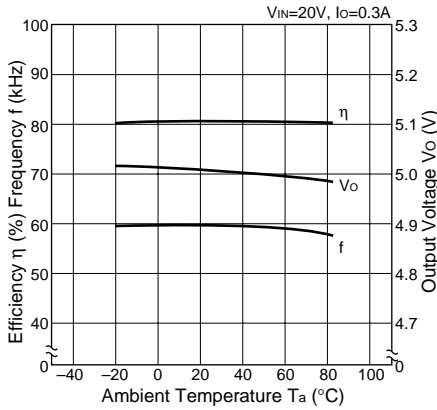

Overcurrent Protection Characteristics(SI-8401L)

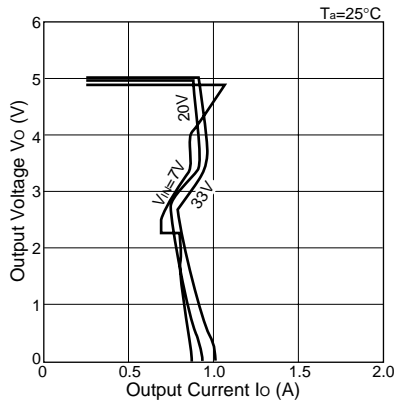

Thermal Protection Characteristics(SI-8401L)

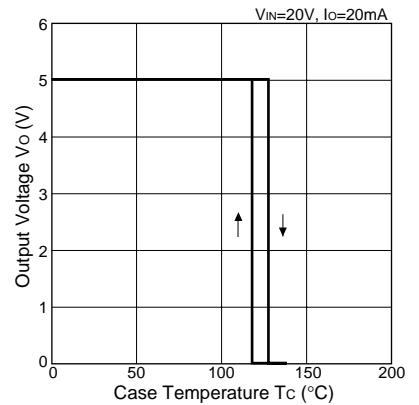

Note on Thermal Protection:

The thermal protection circuit is intended for protection against heat during instantaneous short-circuiting. Its operation is not guaranteed for short-circuiting over extended periods of time.

Rise Characteristics(SI-8402L)

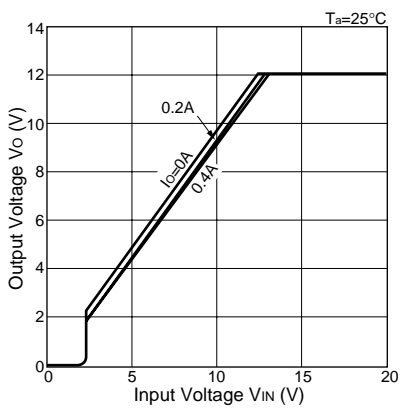

Efficiency Characteristics(SI-8402L)

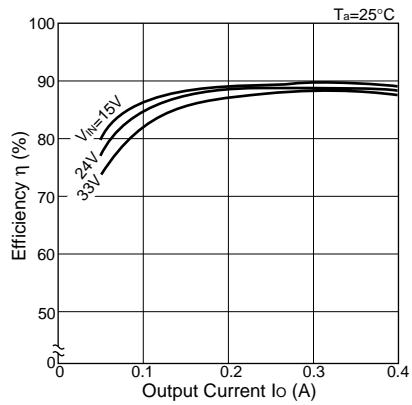

Load Regulation(SI-8402L)

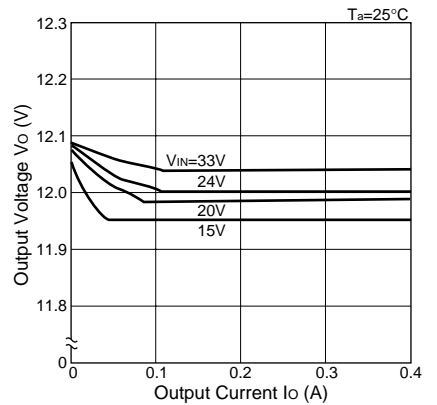

■Typical Characteristics (SI-8500L Series)

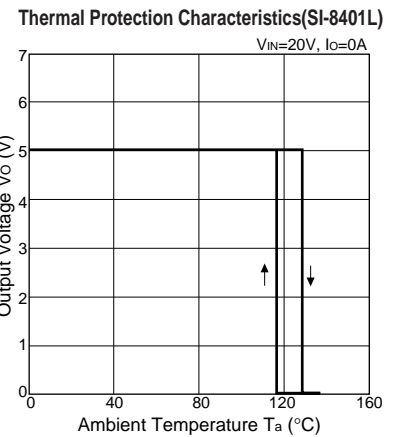
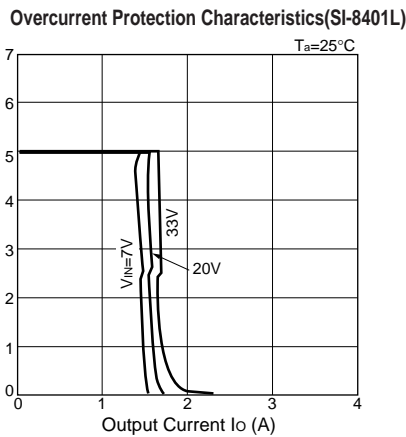
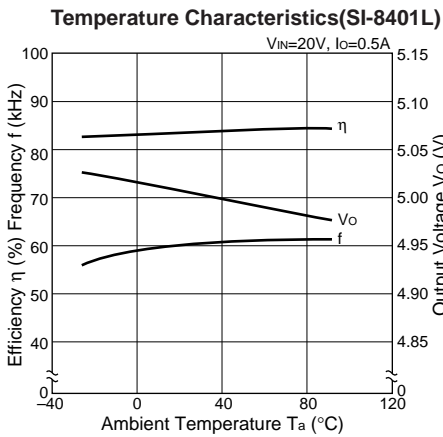
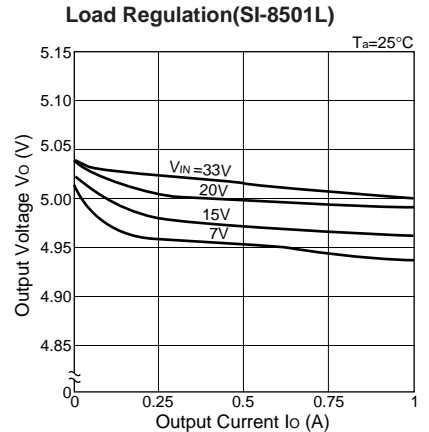
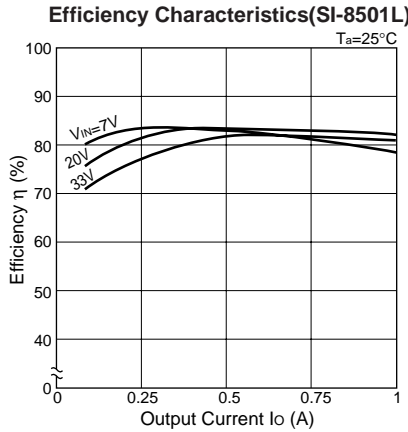
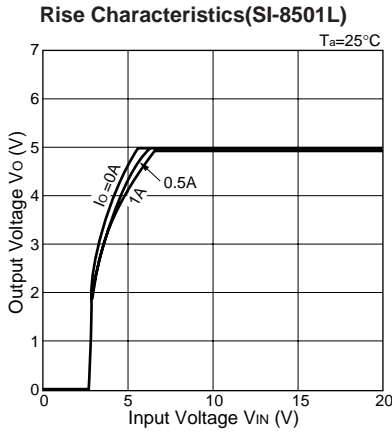

**Note on Thermal Protection:**

The thermal protection circuit is intended for protection against heat during instantaneous short-circuiting. Its operation is not guaranteed for short-circuiting over extended periods of time.

