

SI-8400L/8500L Series

Separate Excitation Switching Type with Coil

■Features

- Integrated switching IC and coil construction
- Requires 2 external components only
- Low switching noise
- Heatsink not required
- Built-in overcurrent and thermal protection circuits
- Built-in soft start circuit (Output ON/OFF control)...SI-8500L Series

■Applications

- Telephone power supplies
- Onboard local power supplies



■Lineup

Part Number	SI-8401L	SI-8402L	SI-8403L	SI-8405L	SI-8501L	SI-8502L	SI-8503L	SI-8504L	SI-8505L
V _o (V)	5.0	12.0	3.3	15.0	5.0	12.0	3.3	9.0	15.0
I _o (A)	0.5	0.4	0.5	0.4	1.0				

■Absolute Maximum Ratings

Parameter	Symbol	Ratings		Unit
		SI-8400L	SI-8500L	
DC Input Voltage	V _{IN}	35		V
Power Dissipation	P _D	1.25	3	W
Junction Temperature	T _j	+100		°C
Storage Temperature	T _{stg}	-25 to +85		°C

■Recommended Operating Conditions

Parameter	Symbol	Ratings				Unit
		SI-8401L	SI-8402L	SI-8403L	SI-8405L	
DC Input Voltage Range	V _{IN}	7 to 33	15 to 33	5.3 to 33	18 to 33	V
Output Current Range	I _o	0 to 0.5	0 to 0.4	0 to 0.5	0 to 0.4	A
Operating Temperature Range	T _{op}	-20 to +85				°C

Parameter	Symbol	Ratings					Unit
		SI-8501L	SI-8502L	SI-8503L	SI-8504L	SI-8505L	
DC Input Voltage Range	V _{IN}	7 to 33	15 to 33	5.3 to 33	12 to 33	18 to 33	V
Output Current Range	I _o	0 to 1.0					A
Operating Temperature Range	T _{op}	-20 to +85					°C

■Electrical Characteristics

(Ta=25°C)

Parameter	Symbol	Ratings												Unit
		SI-8401L			SI-8402L			SI-8403L			SI-8405L			
		min.	typ.	max.	min.	typ.	max.	min.	typ.	max.	min.	typ.	max.	
Output Voltage	Vo	4.80	5.00	5.20	11.40	12.00	12.60	3.17	3.30	3.43	14.25	15.00	15.75	V
	Conditions	VIN=20V, Io=0.3A			VIN=24V, Io=0.3A			VIN=15V, Io=0.3A			VIN=27V, Io=0.3A			
Efficiency	η		80			88			75			89		%
	Conditions	VIN=20V, Io=0.3A			VIN=24V, Io=0.3A			VIN=15V, Io=0.3A			VIN=27V, Io=0.3A			
Switching Frequency	f		60			60			60			60		kHz
	Conditions	VIN=20V, Io=0.3A			VIN=24V, Io=0.3A			VIN=15V, Io=0.3A			VIN=27V, Io=0.3A			
Line Regulation	ΔV _{OLINE}		80	100		100	130		60	80		100	130	mV
	Conditions	VIN=10 to 30V, Io=0.3A			VIN=18 to 30V, Io=0.3A			VIN=8 to 30V, Io=0.3A			VIN=21 to 30V, Io=0.3A			
Load Regulation	ΔV _{OLOAD}		30	40		70	95		20	30		90	120	mV
	Conditions	VIN=20V, Io=0.1 to 0.4A			VIN=24V, Io=0.1 to 0.4A			VIN=15V, Io=0.1 to 0.4A			VIN=27V, Io=0.1 to 0.4A			
Temperature Coefficient of Output Voltage	ΔVo/ΔTa		±0.5			±1.5			±0.5			±1.5		mV/°C
Switching Ripple Voltage (C2=470μF)	ΔV _r		20	40		35	70		15	30		40	80	mV _{p-p}
	Conditions	VIN=20V, Io=0.3A			VIN=24V, Io=0.3A			VIN=15V, Io=0.3A			VIN=27V, Io=0.3A			
Overcurrent Protection Starting Current	Is1	0.55			0.45			0.55			0.45			A
	Conditions	VIN=10V			VIN=18V			VIN=8V			VIN=21V			

(Ta=25°C)

Parameter	Symbol	Ratings												Unit			
		SI-8501L			SI-8502L			SI-8503L			SI-8504L				SI-8505L		
		min.	typ.	max.	min.	typ.	max.	min.	typ.	max.	min.	typ.	max.		min.	typ.	max.
Output Voltage	Vo	4.80	5.00	5.20	11.40	12.00	12.60	3.17	3.30	3.43	8.55	9.00	9.45	14.25	15.00	15.75	V
	Conditions	VIN=20V, Io=0.5A			VIN=24V, Io=0.5A			VIN=15V, Io=0.5A			VIN=21V, Io=0.5A			VIN=25V, Io=0.5A			
Efficiency	η		83			89			79			87		90		%	
	Conditions	VIN=20V, Io=0.5A			VIN=24V, Io=0.5A			VIN=15V, Io=0.5A			VIN=21V, Io=0.5A			VIN=25V, Io=0.5A			
Switching Frequency	f		60			60			60			60		60		kHz	
	Conditions	VIN=20V, Io=0.5A			VIN=24V, Io=0.5A			VIN=15V, Io=0.5A			VIN=21V, Io=0.5A			VIN=25V, Io=0.5A			
Line Regulation	ΔV _{OLINE}		70	130		70	130		50	80		70	130		70	130	mV
	Conditions	VIN=10 to 30V, Io=0.5A			VIN=18 to 30V, Io=0.5A			VIN=8 to 30V, Io=0.5A			VIN=15 to 30V, Io=0.5A			VIN=21 to 30V, Io=0.5A			
Load Regulation	ΔV _{OLOAD}		30	55		30	55		20	45		30	55		30	55	mV
	Conditions	VIN=20V, Io=0.2 to 0.8A			VIN=24V, Io=0.2 to 0.8A			VIN=15V, Io=0.2 to 0.8A			VIN=21V, Io=0.2 to 0.8A			VIN=25V, Io=0.2 to 0.8A			
Temperature Coefficient of Output Voltage	ΔVo/ΔTa		±0.5			±1.5			±0.5			±1.0		±1.5		mV/°C	
Switching Ripple Voltage (C2=470μF)	ΔV _r		45			30			15			25		30		mV _{p-p}	
	Conditions	VIN=20V, Io=0.5A			VIN=24V, Io=0.5A			VIN=15V, Io=0.5A			VIN=21V, Io=0.5A			VIN=25V, Io=0.5A			
Overcurrent Protection Starting Current	Is1	1.1			1.1			1.1			1.1			1.1		A	
	Conditions	VIN=18V			VIN=24V			VIN=12V			VIN=21V			VIN=25V			

■Outline Drawing

(unit:mm)

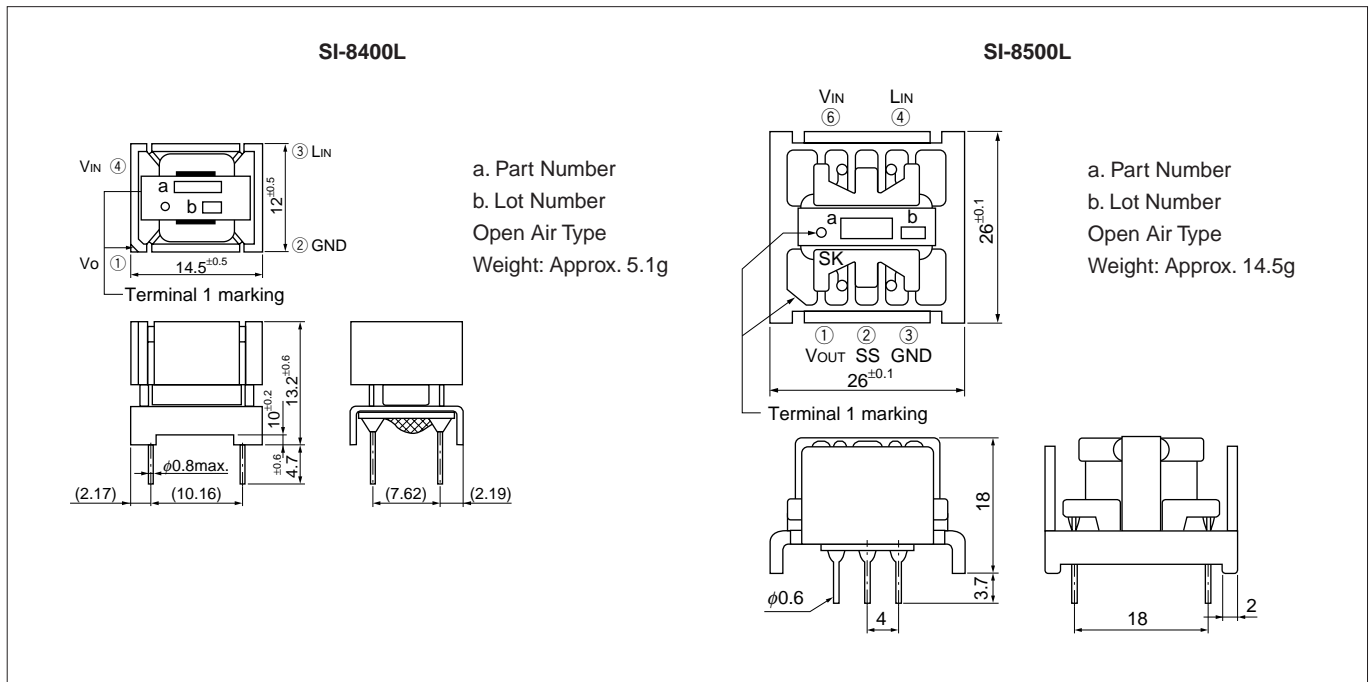

■Block Diagram

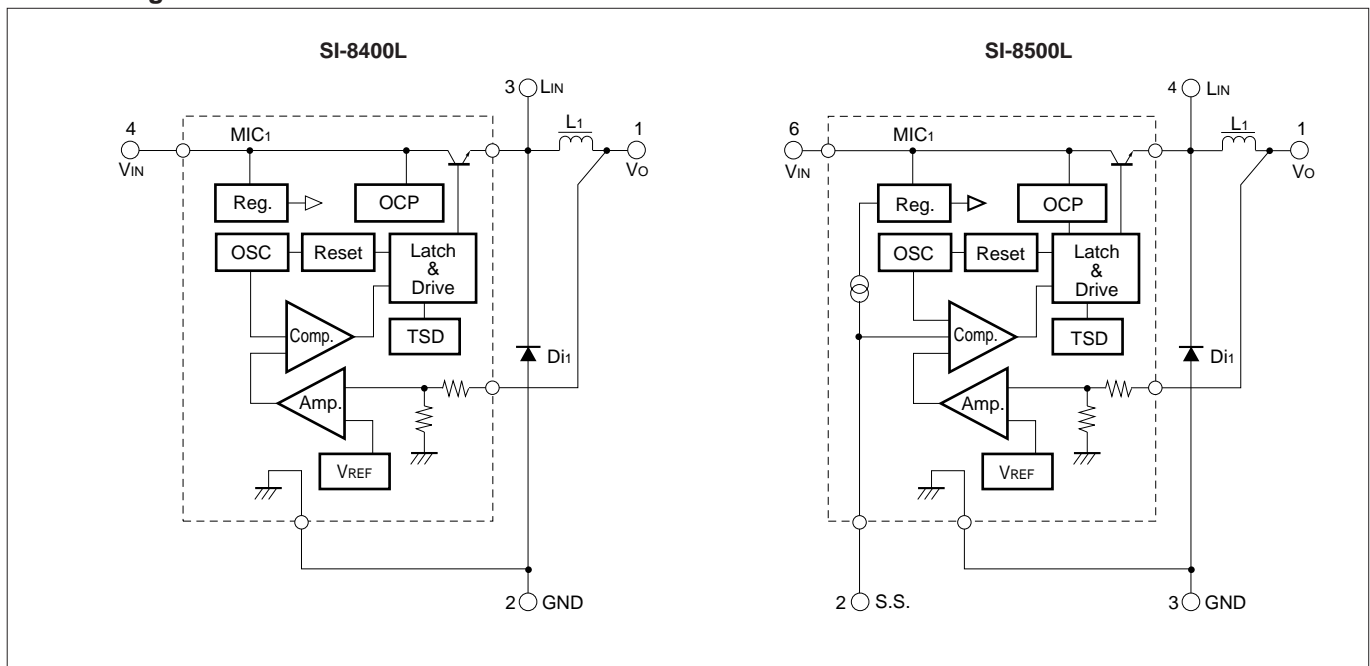

■Standard External Circuit

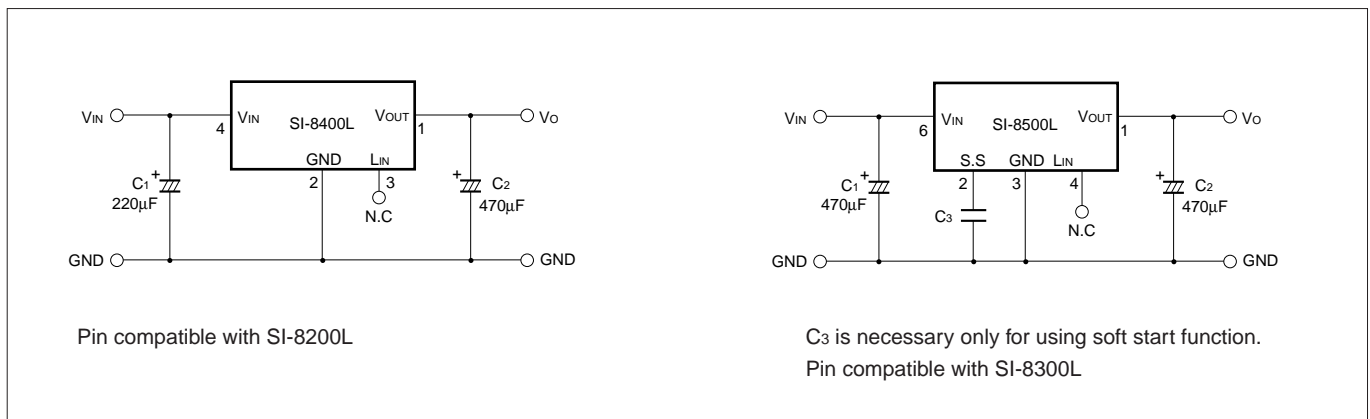

■**T_a-P_d Characteristics**

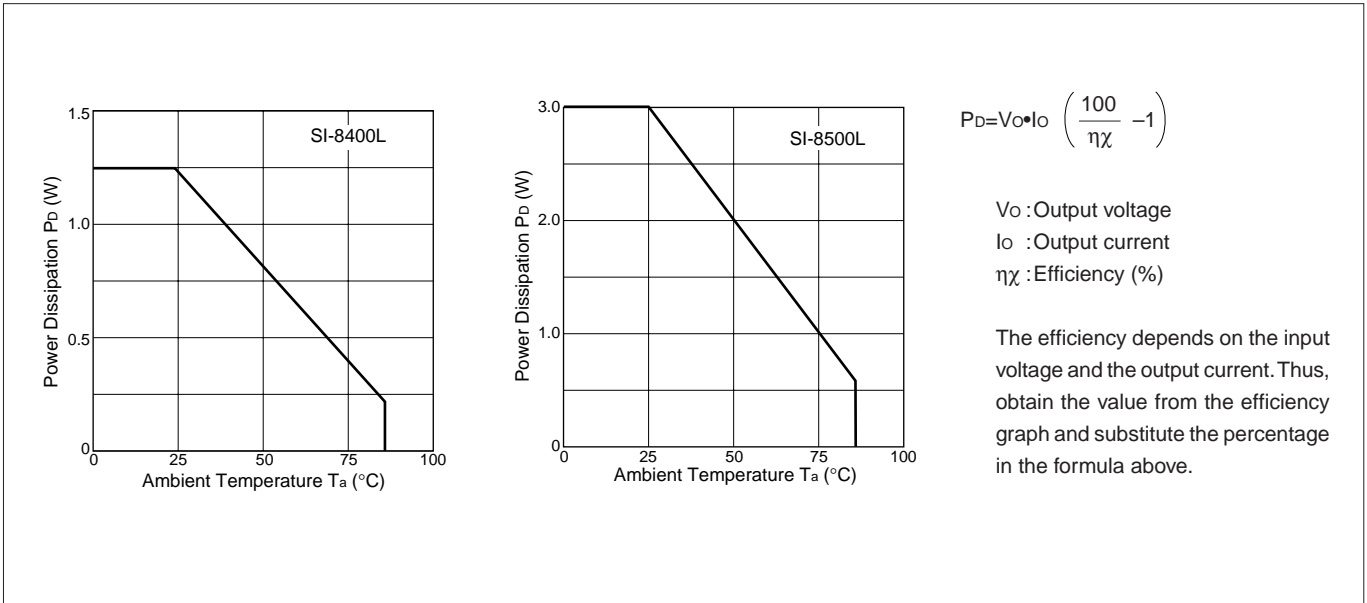

■**SI-8500L application circuit**

Terminal no.2 is for soft start. Connecting a capacitor to the terminal enables the soft start function. See page 85 for the formulas to calculate delay time and rise time. Output can be turned on and off by using the soft start terminal. To stop output, set the soft start terminal voltage to V_{SSL} (0.2V typ.) or less. To switch the potential of the soft start terminal, drive the open collector of the transistor. Since the discharge current from C₃ flows to the ON/OFF control transistor, limit the current for protection. The SS terminal is pulled up to the power supply in the IC and no external voltage can be applied.

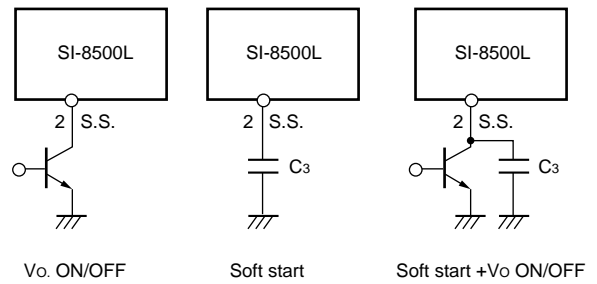

■**Caution**

1. Allocation of Components

For the best operating environment, the ground should be a single ground line at the GND terminal (terminal 2 on the SI-8400L, terminal 3 on the SI-8500L), and the wiring from C₁ and C₂ to ground should be as short as possible.

2. Capacitors C₁ and C₂

1) They must satisfy the breakdown voltage and allowable ripple current.

Exceeding the ratings of these capacitors or using them without derating shortens their service lives and may also cause abnormal oscillation of the IC.

2) C₂ must be a low-impedance type capacitor to ensure minimum ripple voltage and stable switching operation.

3) C₃ (SI-8500L only) is a capacitor for soft start. When not using soft start, leave terminal 2 open. It is pulled up inside the IC.

3. Terminals LIN and NC in the connection diagram must be left unconnected to other circuits.

4. The IC's metallic heatsink is electrically floating. Do not connect it to GND or any other circuit.

5. Since the SI-8400L and 8500L series have an open-package construction, they can only be operated in specific environments. Verify the operating environment and use the conditions indicated in the reliability data.

■Typical Characteristics (SI-8400L Series)

Rise Characteristics(SI-8401L)

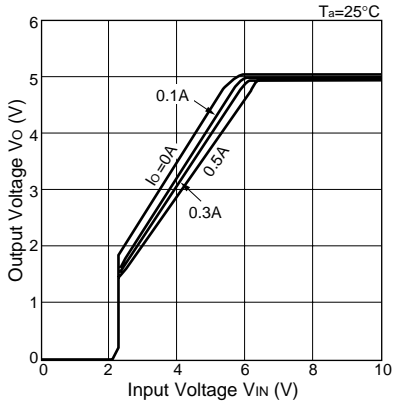

Efficiency Characteristics(SI-8401L)

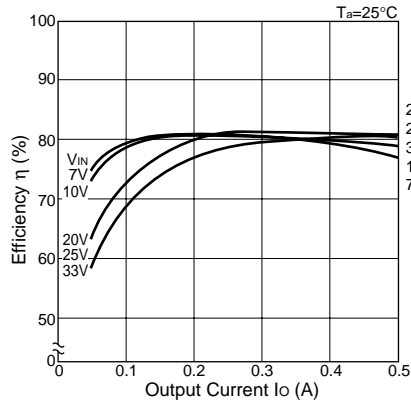

Load Regulation(SI-8401L)

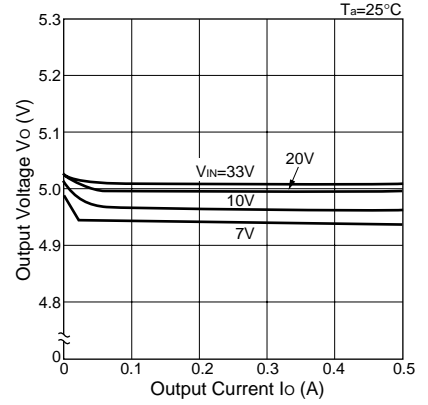

Temperature Characteristics(SI-8401L)

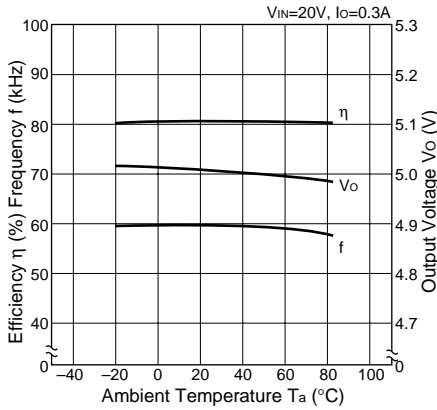

Overcurrent Protection Characteristics(SI-8401L)

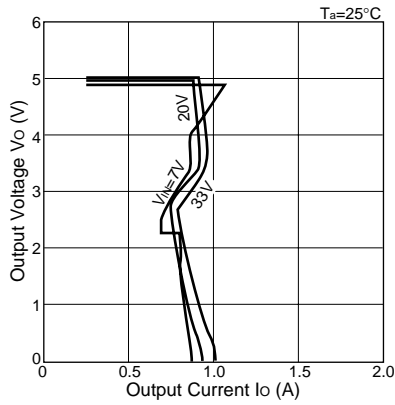

Thermal Protection Characteristics(SI-8401L)

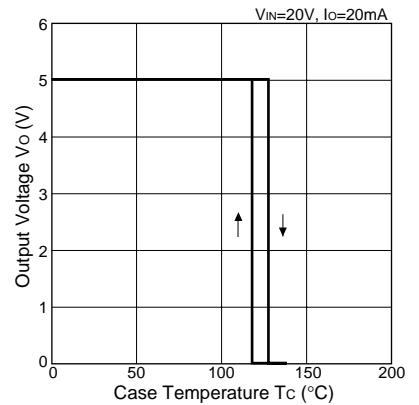

Note on Thermal Protection:

The thermal protection circuit is intended for protection against heat during instantaneous short-circuiting. Its operation is not guaranteed for short-circuiting over extended periods of time.

Rise Characteristics(SI-8402L)

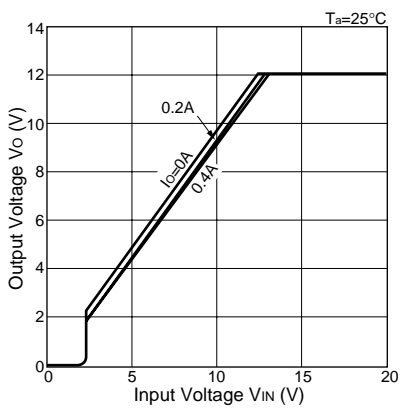

Efficiency Characteristics(SI-8402L)

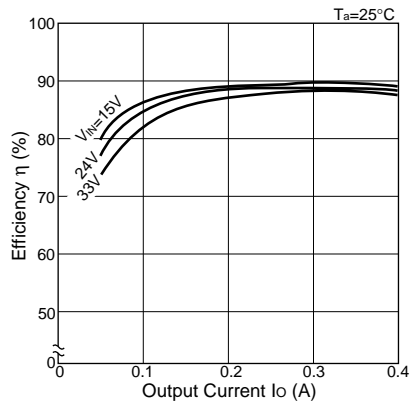

Load Regulation(SI-8402L)

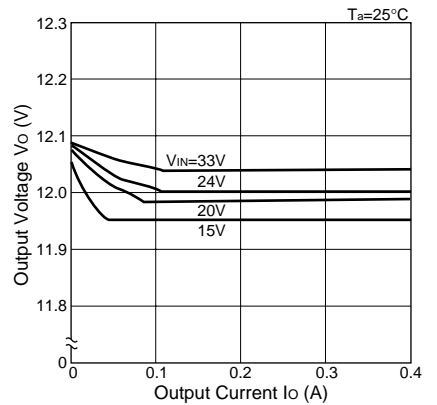

■Typical Characteristics (SI-8500L Series)

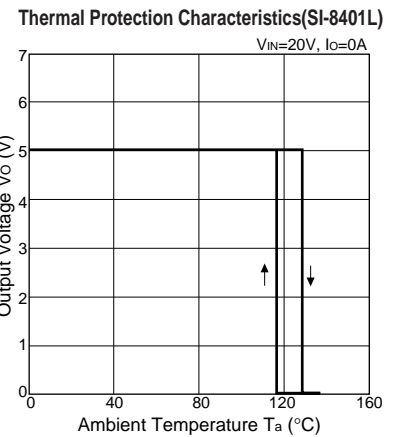
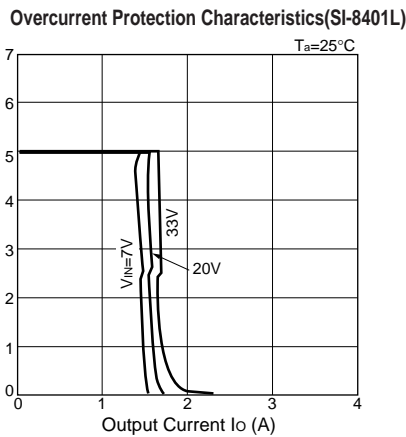
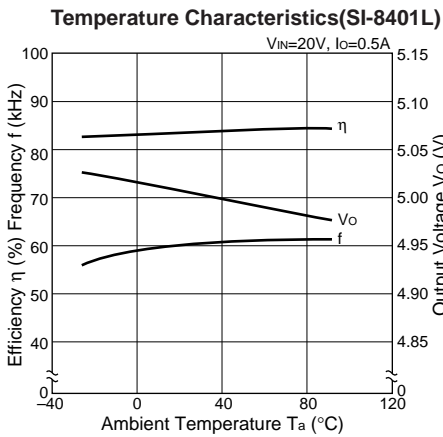
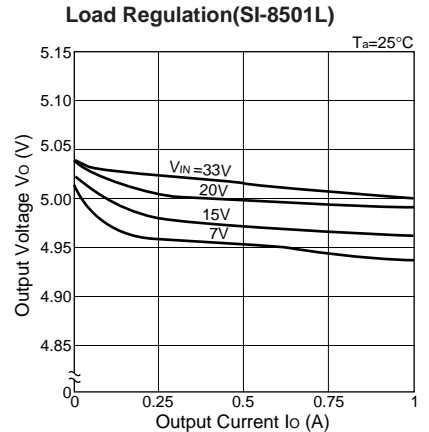
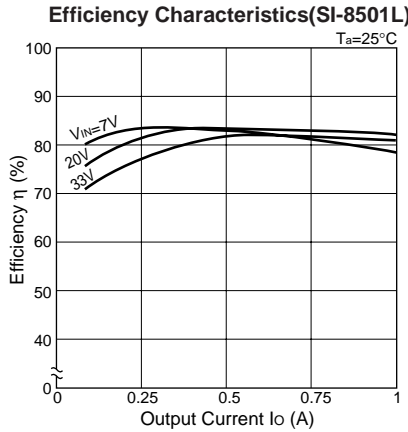
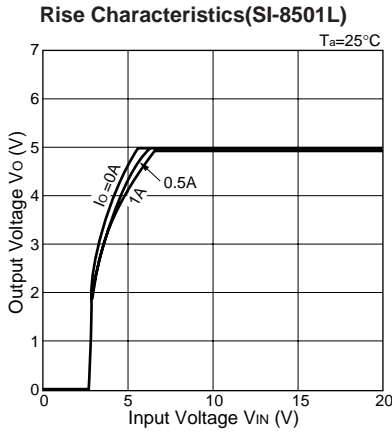

Note on Thermal Protection:

The thermal protection circuit is intended for protection against heat during instantaneous short-circuiting. Its operation is not guaranteed for short-circuiting over extended periods of time.

