

# STR9000 Series

## 5-Terminal, Low Dropout Voltage Dropper Type

### ■Features

- 5-terminal regulator with two screw mount package
- Output current: 4.0A
- Low dropout voltage : $V_{DIF} \leq 1V$  (at  $I_o=4A$ )
- Fine adjustment of output voltage
- Output ON/OFF control
- Built-in foldback overcurrent protection circuits

### ■Applications

- For stabilization of the secondary stage of switching power supplies
- Electronic equipment

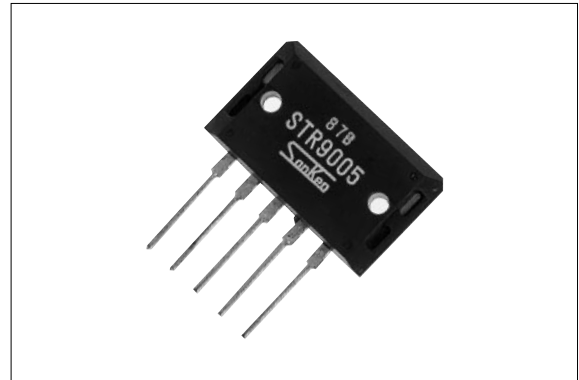

### ■Absolute Maximum Ratings

( $T_a=25^\circ C$ )

Parameter	Symbol	Ratings		Unit
		STR9005	STR9012/9015	
DC Input Voltage	$V_{IN}$	25	30	V
DC Output Current	$I_o$	4.0		A
Power Dissipation	$P_{D1}$	75( $T_c=25^\circ C$ )		W
	$P_{D2}$	3.2(Without heatsink, stand-alone operation)		W
Junction Temperature	$T_j$	-30 to +125		$^\circ C$
Ambient Operating Temperature	$T_{op}$	-20 to +100		$^\circ C$
Storage Temperature	$T_{stg}$	-30 to +125		$^\circ C$
Thermal Resistance (junction to case)	$R_{th(j-c)}$	1.25		$^\circ C/W$

### ■Electrical Characteristics

( $T_a=25^\circ C$ )

Parameter	Symbol	Ratings									Unit
		STR9005			STR9012			STR9015			
		min.	typ.	max.	min.	typ.	max.	min.	typ.	max.	
Input Voltage	$V_{IN}$	6		15	13		25	16		25	V
Output Voltage	$V_o$	4.9	5.0	5.1	11.8	12.0	12.2	14.8	15.0	15.2	V
	Conditions	$V_{IN}=8V, I_o=2.0A$			$V_{IN}=16V, I_o=2.0A$			$V_{IN}=20V, I_o=2.0A$			
Dropout Voltage	$V_{DIF}$			0.5			0.5			0.5	V
	Conditions	$I_o=2.0A$									
	Conditions			1.0			1.0			1.0	
Line Regulation	$\Delta V_{OLINE}$		10	30		30	80		50	100	mV
	Conditions	$V_{IN}=6$ to 15V, $I_o=2.0A$			$V_{IN}=13$ to 25V, $I_o=2.0A$			$V_{IN}=16$ to 25V, $I_o=2.0A$			
	Conditions	$I_o=4.0A$									
Load Regulation	$\Delta V_{OLOAD}$		40	100		80	200		100	200	mV
	Conditions	$V_{IN}=8V, I_o=0$ to 3.0A			$V_{IN}=16V, I_o=0$ to 3.0A			$V_{IN}=20V, I_o=0$ to 3.0A			
Temperature Coefficient of Output Voltage	$\Delta V_o/\Delta T_a$		$\pm 0.5$			$\pm 1.5$			$\pm 1.5$		mV/ $^\circ C$
Ripple Rejection	$R_{REJ}$		54			54			54		dB
	Conditions	$f=100$ to 120Hz									
Overcurrent Protection Starting Current	$I_{s1}$	4.1			4.1			4.1			A
	Conditions	$V_{IN}=8V$			$V_{IN}=16V$			$V_{IN}=20V$			
Output ON/OFF Control Voltage (Voltage between terminal No.3 and 5)	$V_o(ON)$			0.6			0.6			0.6	V
	$V_o(OFF)$	2.0			2.0			2.0			V
Voltage with Output Off	$V_o$			0.5			0.5			0.5	V
	Conditions	$V_{IN}=8V, I_o=0A$			$V_{IN}=15V, I_o=0A$			$V_{IN}=20V, I_o=0A$			

\*Output is turned on when voltage between terminal No.3 and 5 is less than 0.6V, and turned off if more than 2.0V.

■Outline Drawing

(unit:mm)

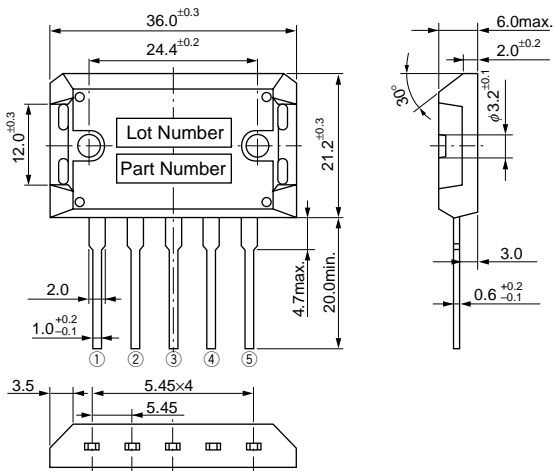

Plastic Mold Package Type  
 Flammability: UL94V-0  
 Weight: Approx. 14.5g

Terminal Connections

- ① Output (backside of case)
- ② Output Fine Adjustment
- ③ Output ON/OFF Control
- ④ Input
- ⑤ Ground

■Block Diagram

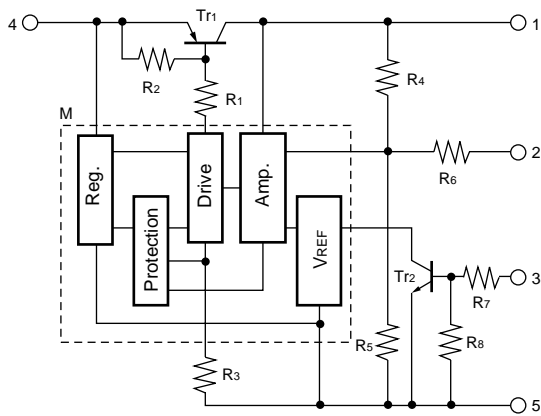

■Standard External Circuit

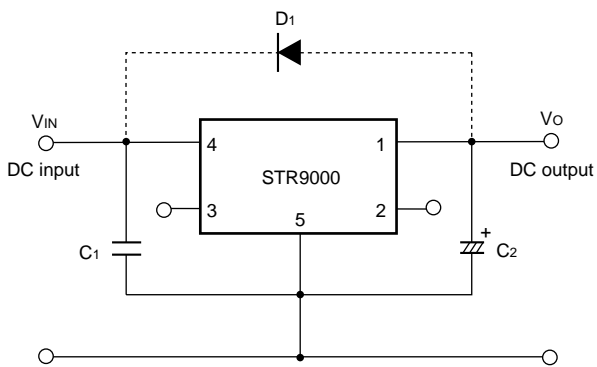

- C1: Oscillation prevention capacitor (approx. 0.33 $\mu$ F)  
Connection to terminal No.4 must be made as short as possible.
- C2: Output capacitor (47 to 100 $\mu$ F)  
Connection to terminal No.1 must be made as short as possible.
- D1: Protection diode (RM1Z)  
Required for protection against reverse biasing of input and output.

- Note 1: Prevention of oscillation at low temperatures  
At low temperatures, oscillation may occur unless an output capacitor with good  $\tan\delta$  is used. Be sure to connect a tantalum capacitor (approx. 10 $\mu$ F) in parallel with output capacitor C2.
- Note 2: An isolation type diode is provided from input to ground and also from output to ground. These may be destroyed if the device is reverse biased. In this case, use a diode with low  $V_F$  to protect them.

■T<sub>a</sub>-P<sub>d</sub> Characteristics

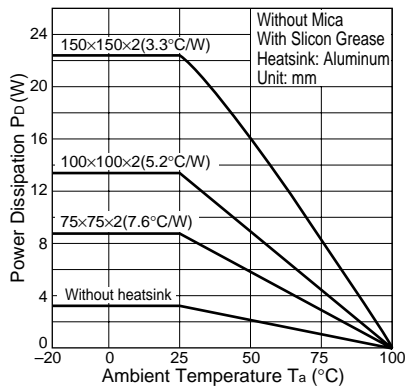

## External Variable Output Voltage Circuit

### 1. Variable output voltage with a single external resistor

The output voltage of the STR9000 series may be decreased by inserting a resistor between terminals No.1 (output terminal) and No.2 (output fine adjustment terminals). Alternatively, the output voltage may be increased by inserting a resistor between terminals No.2 and No.5 (ground terminal).

#### <Standard External Circuit>

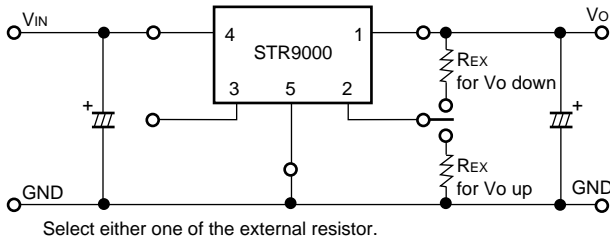

### 2. Fine adjustment of output voltage

The output voltage may be finely adjusted by using terminals No.1, No.2 and No.5 as shown in the following connections.

#### <Standard External Circuit>

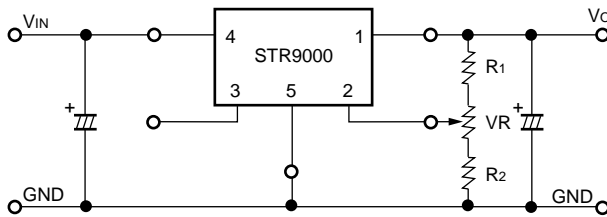

Note: The fine adjustment range of output voltage for the STR9000 series is  $\pm 0.5V$  max for STR9012 and  $+1.0V/-2.0V$  max for STR9015. Adjustment exceeding these values may cause start-up errors.

## ① Typical Characteristics of Variable Output Voltage

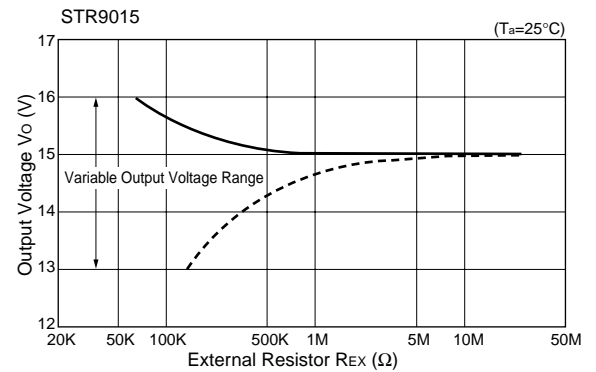
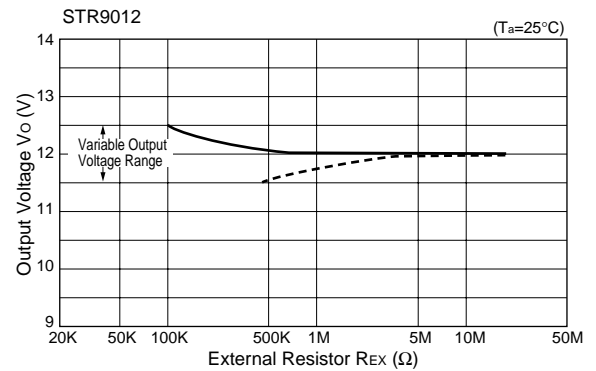
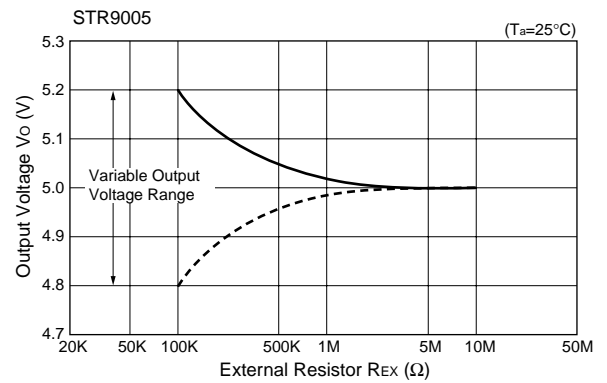

— : Insertion of resistor between terminals No. 2 and No. 5  
 - - - : Insertion of resistor between terminals No. 2 and No. 1

## ② Typical Characteristics of Fine Output Voltage Adjustment

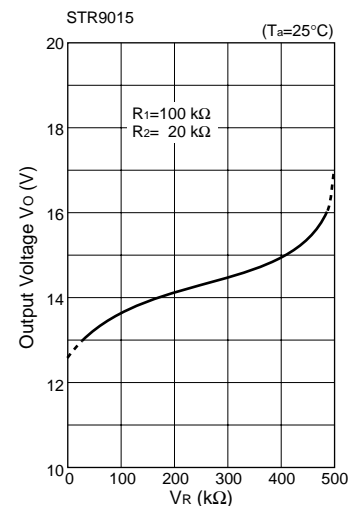
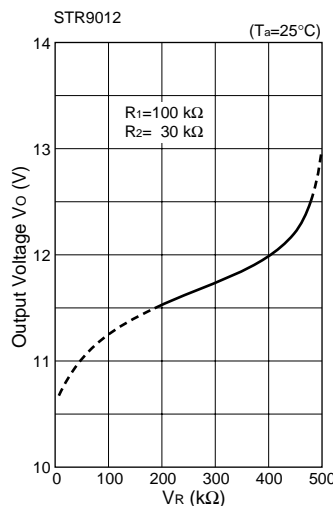
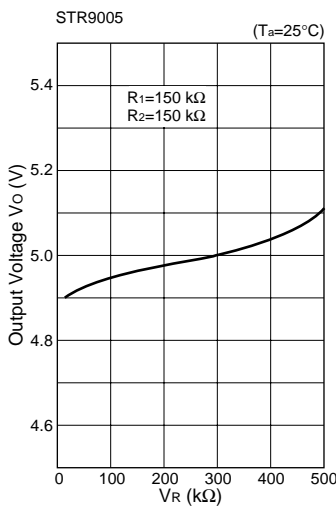

Typical Characteristics

( $T_a=25^{\circ}\text{C}$ )

**$I_o$  vs.  $V_{DIF}$  Characteristics**

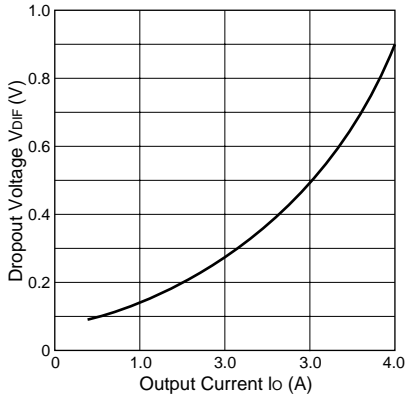

**Temperature Coefficient of Output Voltage(STR9005)**

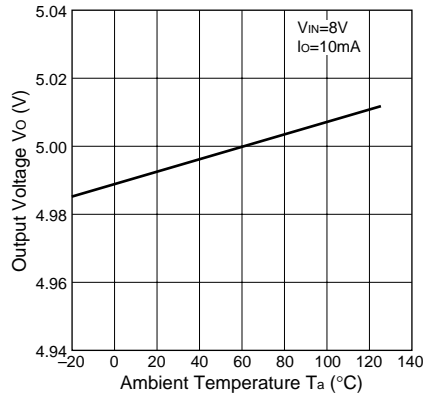

**Circuit Current(STR9005)**

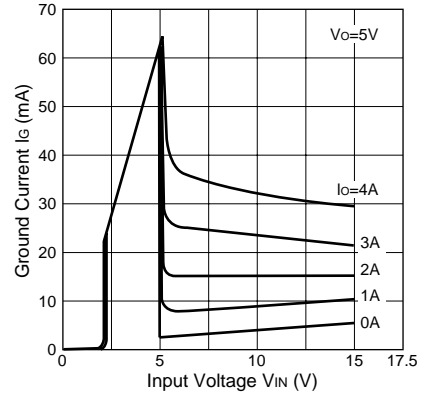

**Rise Characteristics(STR9005)**

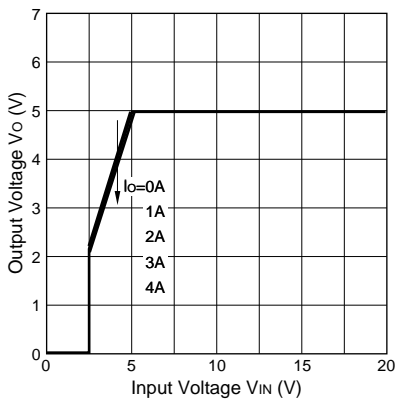

**Rise Characteristics(STR9012)**

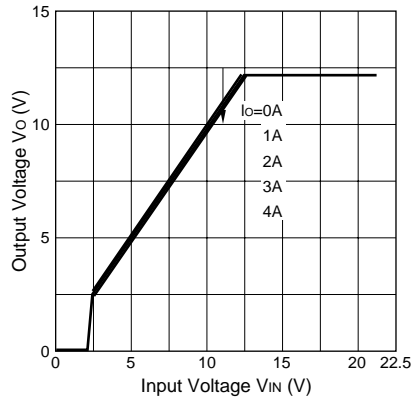

**Rise Characteristics(STR9015)**

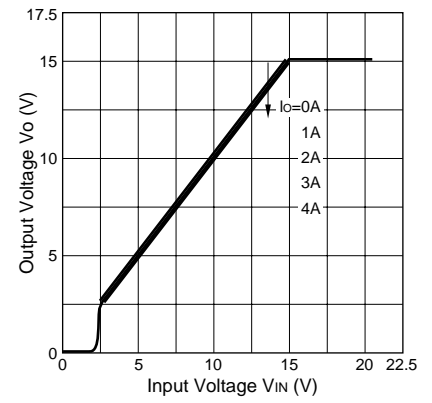

**Overcurrent Protection Characteristics(STR9005)**

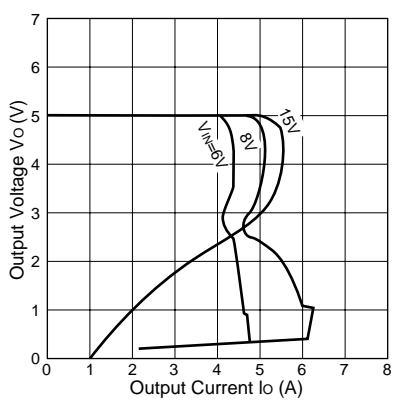

**Overcurrent Protection Characteristics(STR9012)**

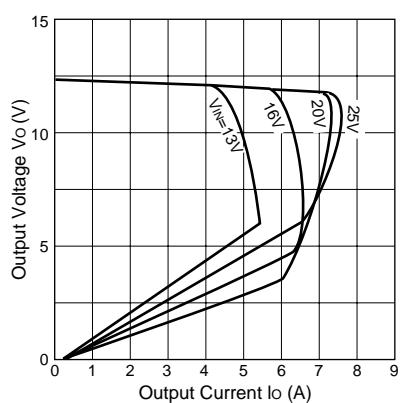

**Overcurrent Protection Characteristics(STR9015)**

