

# 2SC3851/3851A

Silicon NPN Epitaxial Planar Transistor (Complement to type 2SA1488/A)

Application : Audio and PPC High Voltage Power Supply, and General Purpose

**Absolute maximum ratings** (Ta=25°C)

Symbol	2SC3851	2SC3851A	Unit
V <sub>CB0</sub>	80	100	V
V <sub>CEO</sub>	60	80	V
V <sub>EB0</sub>	6		V
I <sub>c</sub>	4		A
I <sub>B</sub>	1		A
P <sub>c</sub>	25 (T <sub>c</sub> =25°C)		W
T <sub>j</sub>	150		°C
T <sub>stg</sub>	-55 to +150		°C

**Electrical Characteristics** (Ta=25°C)

Symbol	Conditions	2SC3851	2SC3851A	Unit
I <sub>CB0</sub>		100max		μA
	V <sub>CB</sub> =	80	100	V
I <sub>EB0</sub>	V <sub>EB</sub> =6V	100max		μA
V <sub>(BR)CEO</sub>	I <sub>c</sub> =25mA	60min	80min	V
h <sub>FE</sub>	V <sub>CE</sub> =4V, I <sub>c</sub> =1A	40 to 320		
V <sub>CE(sat)</sub>	I <sub>c</sub> =2A, I <sub>B</sub> =0.2A	0.5max		V
f <sub>T</sub>	V <sub>CE</sub> =12V, I <sub>E</sub> =-0.2A	15typ		MHz
C <sub>OB</sub>	V <sub>CB</sub> =10V, f=1MHz	60typ		pF

**Typical Switching Characteristics (Common Emitter)**

V <sub>CC</sub> (V)	R <sub>L</sub> (Ω)	I <sub>c</sub> (A)	V <sub>BB1</sub> (V)	V <sub>BB2</sub> (V)	I <sub>B1</sub> (mA)	I <sub>B2</sub> (mA)	t <sub>on</sub> (μs)	t <sub>stg</sub> (μs)	t <sub>f</sub> (μs)
12	6	2	10	-5	200	-200	0.2typ	1typ	0.3typ

**External Dimensions FM20(TO220F)**

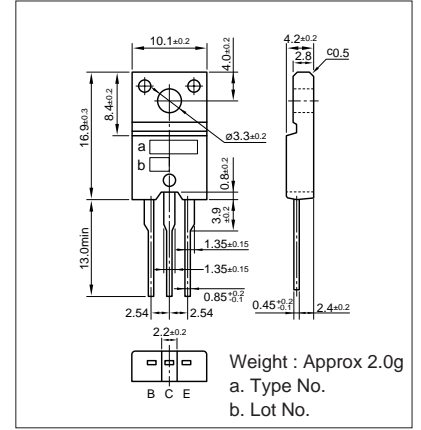

**I<sub>c</sub>-V<sub>CE</sub> Characteristics (Typical)**

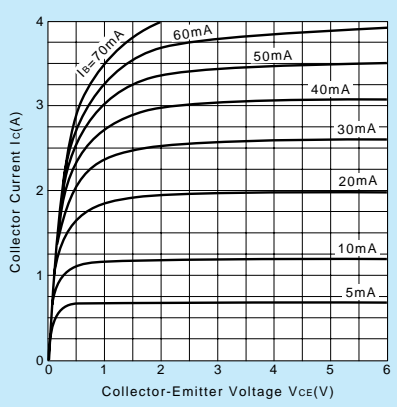

**V<sub>CE(sat)</sub>-I<sub>B</sub> Characteristics (Typical)**

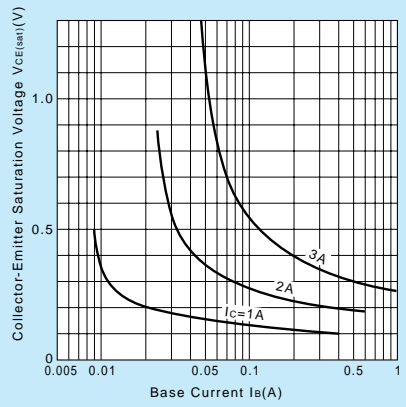

**I<sub>c</sub>-V<sub>BE</sub> Temperature Characteristics (Typical)**

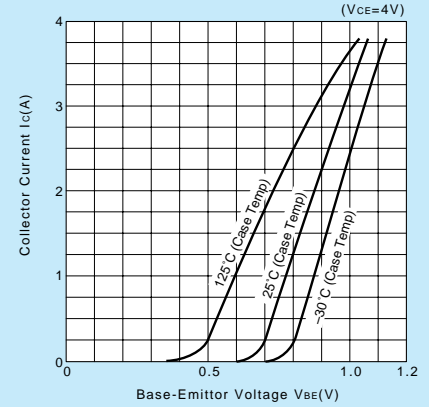

**h<sub>FE</sub>-I<sub>c</sub> Characteristics (Typical)**

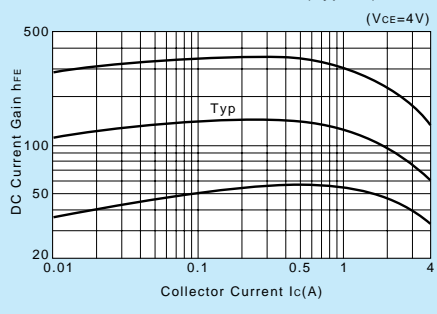

**h<sub>FE</sub>-I<sub>c</sub> Temperature Characteristics (Typical)**

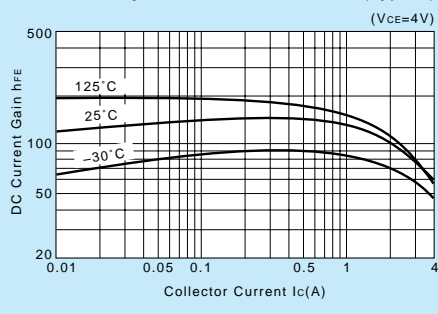

**θ<sub>j-a</sub>-t Characteristics**

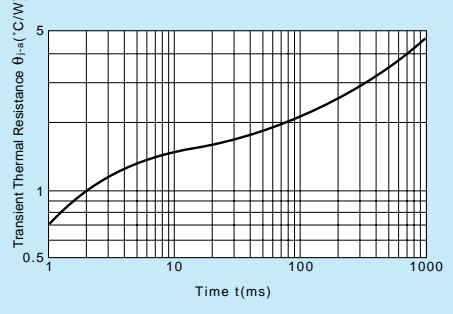

**f<sub>T</sub>-I<sub>E</sub> Characteristics (Typical)**

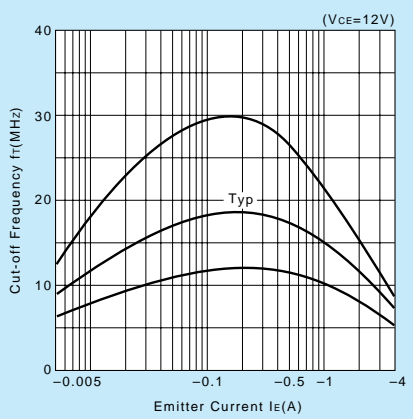

**Safe Operating Area (Single Pulse)**

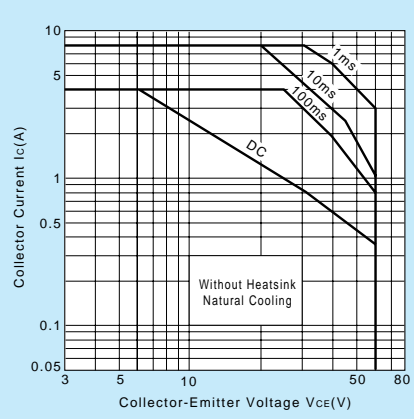

**P<sub>c</sub>-T<sub>a</sub> Derating**

