

Square display LEDs

SEL1020 series

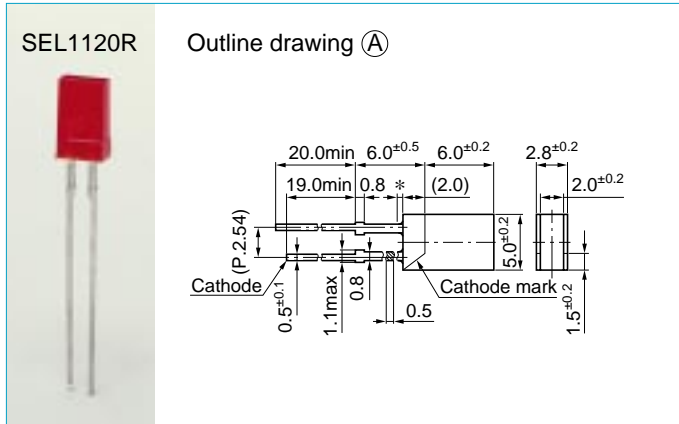

SEL1021 series

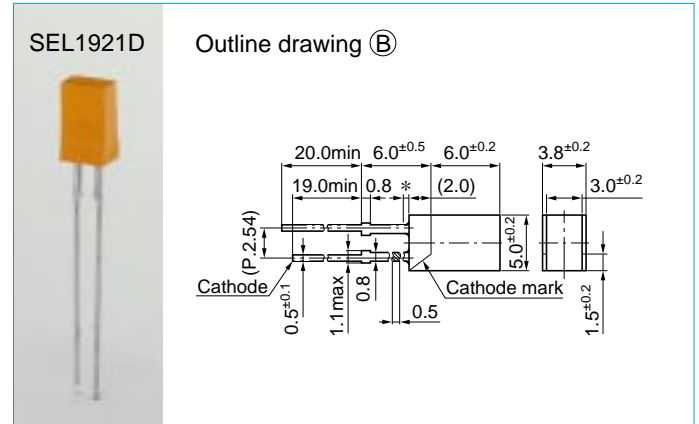

SEL1022 series

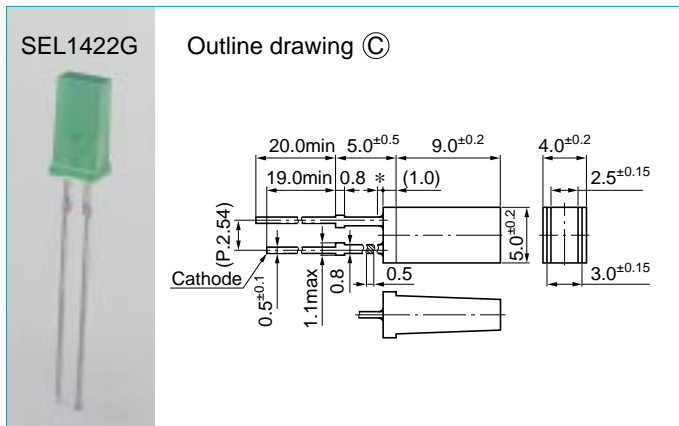



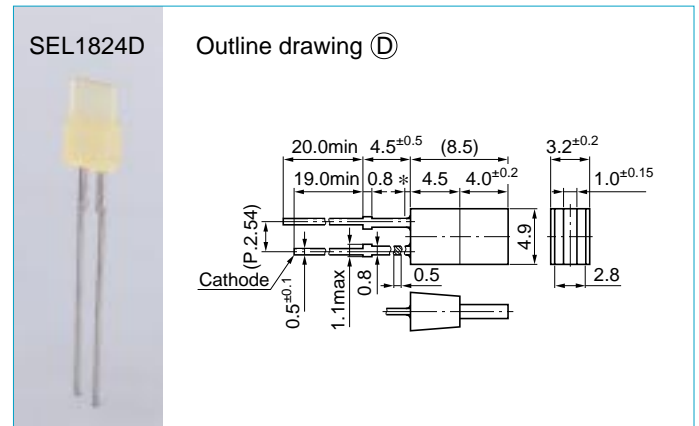

















SEL1024 series



External dimensions: Unit: mm Tolerance: ±0.3
 * Resin heap: 1.5 mm Max

Absolute maximum ratings (Ta=25°C)

Symbol	Unit	Ratings
I _F	mA	30
I _{FP}	mA	100
V _R	V	3
Top	°C	-30 to +85
Tstg	°C	-30 to +100

Type No.	Display form (ø: mm)	Type of lens	Emitting color	Electro-optical characteristics (Ta=25°C)									Outline drawing	
				V _F (V)		Condition I _F (mA)	I _R (μA)	Condition V _R (V)	I _v (mcd)		λ _p (nm)	Δλ		
				typ	max				typ	Condition I _F (mA)				
SEL1120R	 2x5	Red tinted, diffused	Red	2.0	2.5	10	50	3	0.7	10	700	100	Ⓐ	
SEL1420G	 2x5	Green tinted, diffused	Green								2.0	20		560
SEL1720Y	 2x5	Yellow tinted, diffused	Yellow	1.9	2.5	10	50	3	0.7	10	570	40		
SEL1820D	 2x5	Orange tinted, diffused	Amber								2.0	610		35
SEL1920D	 2x5	Orange tinted, diffused	Orange								0.7	587		33
SEL1121R	 3x5	Red tinted, diffused	Red	2.0	2.5	10	50	3	0.7	10	700	100	Ⓑ	
SEL1421G	 3x5	Green tinted, diffused	Green								2.0	20		560
SEL1721Y	 3x5	Yellow tinted, diffused	Yellow	1.9	2.5	10	50	3	0.7	10	570	40		
SEL1821D	 3x5	Orange tinted, diffused	Amber								1.5	610		35
SEL1921D	 3x5	Orange tinted, diffused	Orange								0.7	587		33
SEL1222R	 2.5x5	Red tinted, diffused	High intensity red	1.9	2.5	10	50	3	5.0	20	630	35	Ⓒ	
SEL1422G	 2.5x5	Green tinted, diffused	Green	2.0							4.0	560		20
SEL1722Y	 2.5x5	Yellow tinted, diffused	Yellow	1.9	2.5	10	50	3	4.0	10	570	40		
SEL1822D	 2.5x5	Orange tinted, diffused	Amber								2.5	610		35
SEL1922D	 2.5x5	Orange tinted, diffused	Orange								3.0	587		33
SEL1124R	 1x4.9	Red tinted, diffused	Red	2.0	2.5	10	50	3	0.7	10	700	100	Ⓓ	
SEL1424G	 1x4.9	Green tinted, diffused	Green								2.0	20		560
SEL1724Y	 1x4.9	Yellow tinted, diffused	Yellow	1.9	2.5	10	50	3	0.7	10	570	40		
SEL1824D	 1x4.9	Orange tinted, diffused	Amber								2.1	610		35
SEL1924D	 1x4.9	Orange tinted, diffused	Orange								0.7	587		33