

4ø round-type contact mount LEDs (for automatic insertion)

SEL4014 series

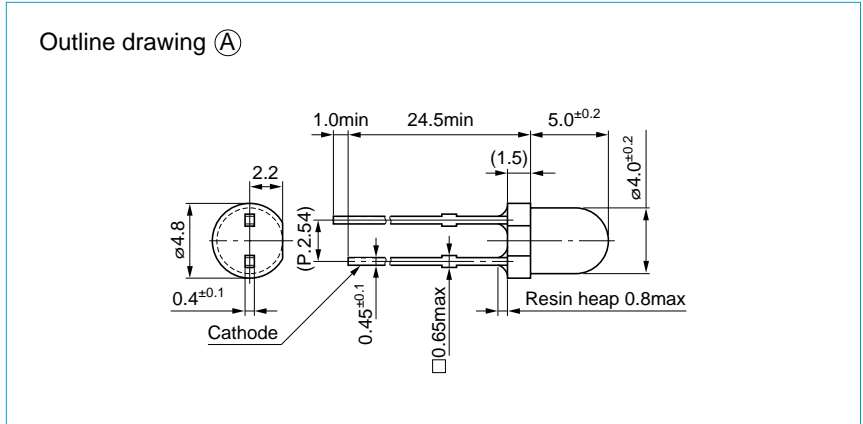

External dimensions: Unit: mm Tolerance: ±0.3

Absolute maximum ratings (Ta=25°C)

Symbol	Unit	Ratings
I _F	mA	30
I _{FP}	mA	100
V _R	V	3
Top	°C	-30 to +85
Tstg	°C	-30 to +100

Viewing angle

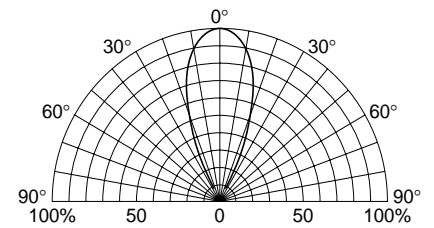
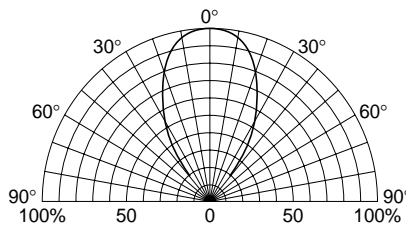

Type No.	Display form (ø: mm)	Type of lens	Emitting color	Electro-optical characteristics (Ta=25°C)								Outline drawing	
				V _F (V)		Condition I _F (mA)	I _R (μA)	Condition V _R (V)	I _v (mcd)		λ _p (nm)		Δλ (nm)
				typ	max				typ	Condition I _F (mA)			
SEL4114R	●4	Red tinted, diffused	Red	2.0	2.5	10	50	3	2.0	10	700	100	(A)
SEL4114S	●4	Red tinted, non-diffused							3.0				
SEL4214R	●4	Light red tinted, diffused	High intensity red	1.9	2.5	10	50	3	12.0	20	630	35	
SEL4214S	●4	Light red tinted, non-diffused							25.0				
SEL4414G	●4	Light green tinted, diffused	Green	2.0	2.5	10	50	3	24.0	10	560	20	
SEL4414E	●4	Light green tinted, non-diffused							30.0				
SEL4714Y	●4	Yellow tinted, diffused	Yellow	2.0	2.5	10	50	3	13.0	10	570	40	
SEL4714K	●4	Yellow tinted, non-diffused							17.0				
SEL4814D	●4	Orange tinted, diffused	Amber	1.9	2.5	10	50	3	4.5	10	610	35	
SEL4814A	●4	Orange tinted, non-diffused							7.5				
SEL4914D	●4	Orange tinted, diffused	Orange	1.9	2.5	10	50	3	5.5	10	587	33	
SEL4914A	●4	Orange tinted, non-diffused							16.0				