

5-mm pitch lead contact mount LEDs (for automatic insertion)

SEL5020 series (Flat type)

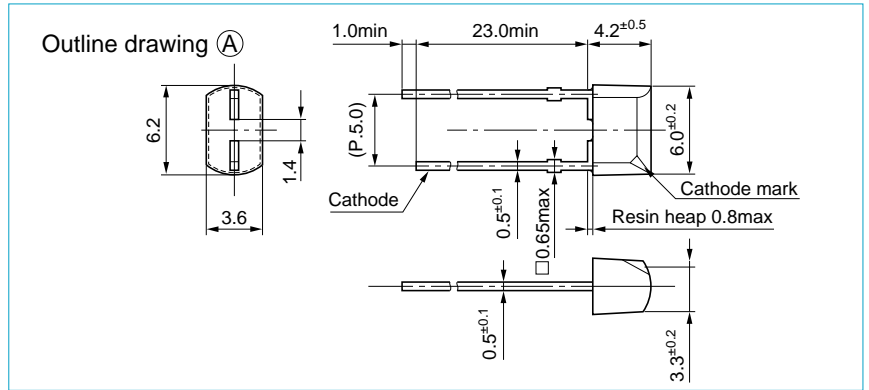

SEL5021 series (∅3 lens type)

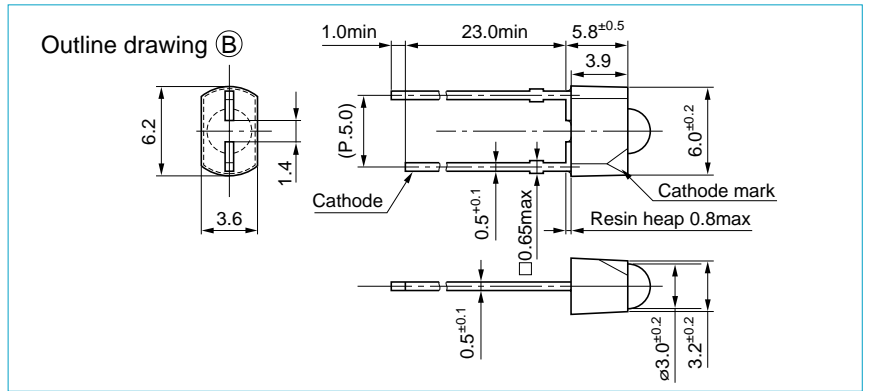

SEL5023 series (Bow-lens type)

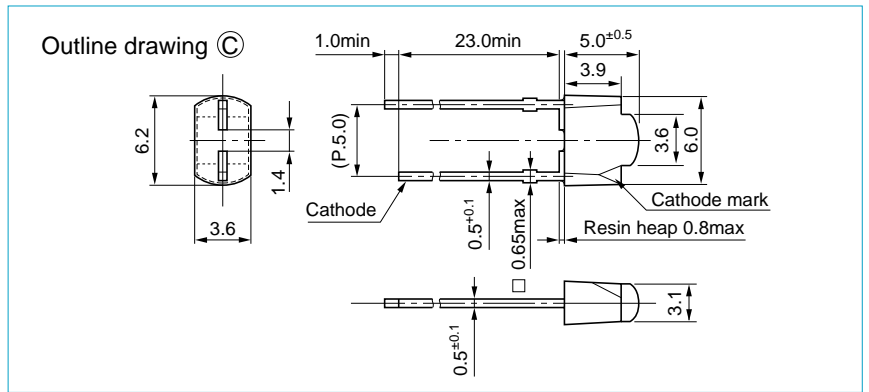

External dimensions: Unit: mm Tolerance: ±0.3

Viewing angle

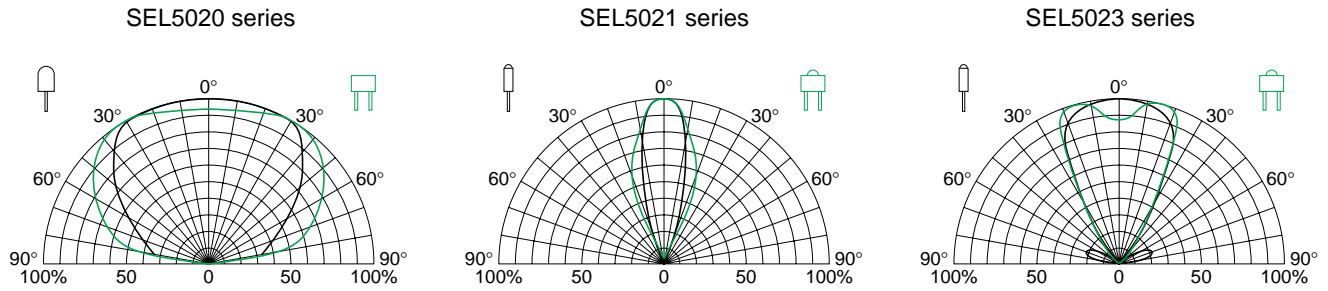

Absolute maximum ratings (Ta=25°C)

Symbol	Unit	Ratings
I_F	mA	30
I_{FP}	mA	100
V_R	V	3
Top	°C	-30 to +85
Tstg	°C	-30 to +100

Type No.	Display form (ϕ : mm)	Type of lens	Emitting color	Electro-optical characteristics (Ta=25°C)									Outline drawing
				V_F (V)		Condition I_F (mA)	I_R (μ A)	Condition V_R (V)	I_v (mcd)		λ_p (nm)	$\Delta\lambda$ (nm)	
				typ	max				typ	Condition I_F (mA)			
SEL5220S	3.3×6	Red tinted, non-diffused	High intensity red	1.9	2.5	10	50	3	2.8	20	630	35	Ⓐ
SEL5420E	3.3×6	Green tinted, non-diffused	Green	2.0					6.8		560	20	
SEL5520C	3.3×6	Un-tinted, non-diffused	Pure green	2.0					2.4		555	20	
SEL5820A	3.3×6	Orange tinted, non-diffused	Amber	1.9					6.0		610	35	
SEL5920A	3.3×6	Orange tinted, non-diffused	Orange	1.9					4.4		587	33	
SEL5221S	ϕ 3	Red tinted, non-diffused	High intensity red	1.9	2.5	10	50	3	14	20	630	35	Ⓑ
SEL5421E	ϕ 3	Green tinted, non-diffused	Green	2.0					36		560	20	
SEL5521C	ϕ 3	Un-tinted, non-diffused	Pure green	2.0					14		555	20	
SEL5821A	ϕ 3	Orange tinted, non-diffused	Amber	1.9					22		610	35	
SEL5921A	ϕ 3	Orange tinted, non-diffused	Orange	1.9					22		587	33	
SEL5223S	3.1×3.6	Red tinted, non-diffused	High intensity red	1.9	2.5	10	50	3	6	20	630	35	Ⓒ
SEL5423E	3.1×3.6	Green tinted, non-diffused	Green	2.0					14		560	20	
SEL5823A	3.1×3.6	Orange tinted, non-diffused	Amber	2.0					9		610	35	
SEL5923A	3.1×3.6	Orange tinted, non-diffused	Orange	1.9					9		587	33	