

High-side Power Switch with Diagnostic Function SI-5152S

Features

- Built-in diagnostic function to detect short and open circuiting of loads and output status signals
- Low saturation PNP transistor use
- Allows direct driving using LS-TTL and C-MOS logic levels
- Built-in overcurrent and thermal protection circuits
- Built-in protection against reverse connection of power supply
- $T_j = 150^\circ\text{C}$ guaranteed
- TO-220 equivalent full-mold package not require insulation mica

Absolute Maximum Ratings

($T_a = 25^\circ\text{C}$)

Parameter	Symbol	Ratings	Unit	Conditions
Power supply voltage	V_B	40	V	
Input terminal voltage	V_{IN}	-0.3 to V_B	V	
DIAG terminal voltage	V_{DIAG}	6	V	
Collector-emitter voltage	V_{CE}	40	V	
Output current	I_O	1.8	A	
Power Dissipation	P_{D1}	22	W	With infinite heatsink ($T_c = 25^\circ\text{C}$)
	P_{D2}	1.8	W	Stand-alone without heatsink
Junction temperature	T_j	-40 to $+150$	$^\circ\text{C}$	
Operating temperature	T_{OP}	-40 to $+100$	$^\circ\text{C}$	
Storage temperature	T_{Stg}	-40 to $+150$	$^\circ\text{C}$	

Electrical Characteristics

($T_a = 25^\circ\text{C}$ unless otherwise specified)

Parameter	Symbol	Ratings			Unit	Conditions	
		min	typ	max			
Operating power supply voltage	V_{Bopr}	6.0		30	V		
Quiescent circuit current	I_q		5	12	mA	$V_{Bopr} = 14\text{V}$, $V_{IN} = 0\text{V}$	
Saturation voltage of output transistor	$V_{CE(sat)}$			0.5	V	$I_O \leq 1.0\text{A}$, $V_{Bopr} = 6$ to 16V	
				1.0	V	$I_O \leq 1.8\text{A}$, $V_{Bopr} = 6$ to 16V	
Output leak current	$I_{O, leak}$			2	mA	$V_{CEO} = 16\text{V}$, $V_{IN} = 0\text{V}$	
Input voltage	Output ON	V_{IH}	2.0		V_B	V	$V_{Bopr} = 6$ to 16V
	Output OFF	V_{IL}	-0.3		0.8	V	$V_{Bopr} = 6$ to 16V
Input current	Output ON	I_{IH}			1	mA	$V_{IN} = 5\text{V}$
	Output OFF	I_{IL}	-0.1			mA	$V_{IN} = 0\text{V}$
Overcurrent protection starting current	I_S	1.9				A	$V_{Bopr} = 14\text{V}$, $V_O = V_{Bopr} - 1.5\text{V}$
Thermal protection starting temperature	T_{TSD}	150				$^\circ\text{C}$	$V_{Bopr} \geq 6\text{V}$
Open load detection resistor	R_{open}			30		$\text{k}\Omega$	$V_{Bopr} = 6$ to 16V
Output transfer time	T_{ON}		8	30		μS	$V_{Bopr} = 14\text{V}$, $I_O = 1\text{A}$
	T_{OFF}		15	30		μS	$V_{Bopr} = 14\text{V}$, $I_O = 1\text{A}$
DIAG output leak current	I_{DIAG}			100		μA	$V_{CC} = 6\text{V}$, $V_{Bopr} = 6$ to 16V
Saturation voltage of DIAG output	V_{DL}			0.3		V	$V_{CC} = 6\text{V}$, $V_{Bopr} = 6$ to 16V , $I_{DO} = 2\text{mA}$
DIAG output transfer time	T_{PLH}			30		μS	$V_{Bopr} = 14\text{V}$, $I_O = 1\text{A}$
	T_{PHL}			30		μS	$V_{Bopr} = 14\text{V}$, $I_O = 1\text{A}$
Minimum load inductance	L	1				mH	

Note:

- * The rule of protection against reverse connection of power supply is $V_B = -13\text{V}$, one minute (all terminals except, V_B and GND, are open).

External Dimensions (unit: mm)

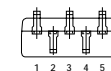
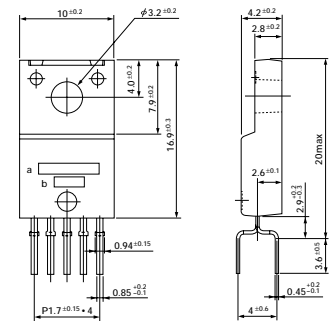

1. GND
 2. V_{IN}
 3. V_O
 4. DIAG
 5. V_B
- a: Type No.
b: Lot No.

(Forming No. 1111)

Standard Circuit Diagram

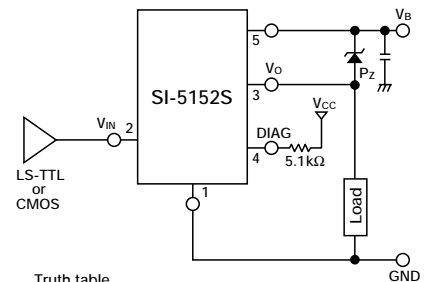

Truth table

V_{IN}	V_O
H	H
L	L

Diagnostic Function

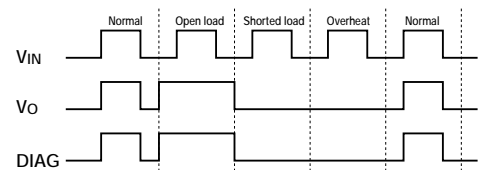

Mode	V_{IN}	V_O	DIAG
Normal	L	L	L
	H	H	H
Open load	L	H	H
	H	H	H
Shorted load	L	L	L
	H	L	L
Overheat	L	L	L
	H	L	L

- DIAG output will be undetermined when a voltage exceeding 25V is applied to V_B terminal.

■ Quiescent Circuit Current

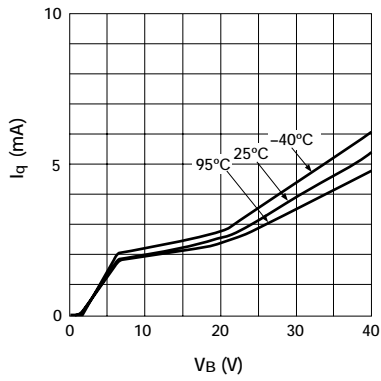

■ Circuit Current

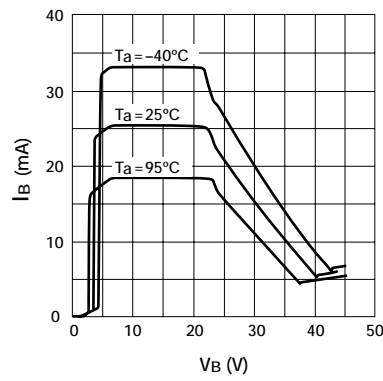

■ Saturation Voltage of Output Transistor

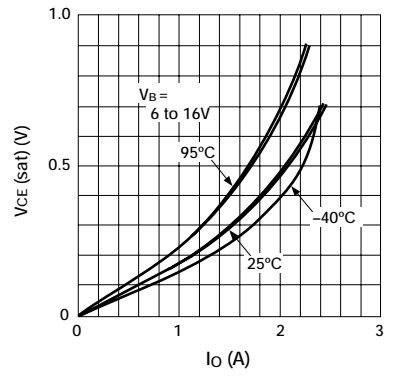

■ Overcurrent Protection Characteristics ($T_a = -40^\circ\text{C}$)

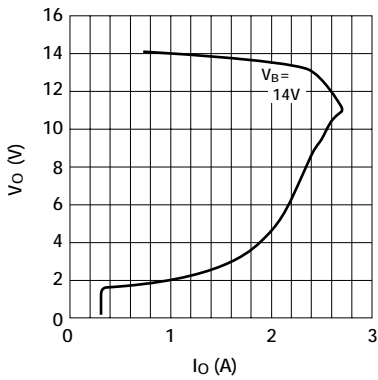

■ Overcurrent Protection Characteristics ($T_a = 25^\circ\text{C}$)

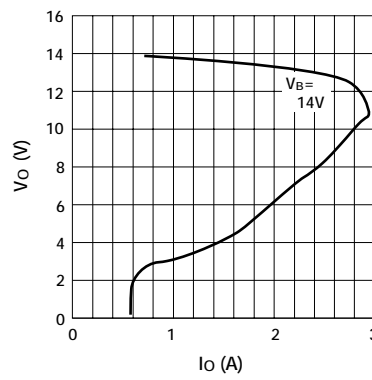

■ Overcurrent Protection Characteristics ($T_a = 100^\circ\text{C}$)

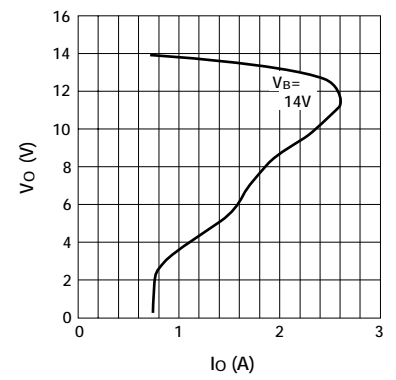

■ Threshold input voltage

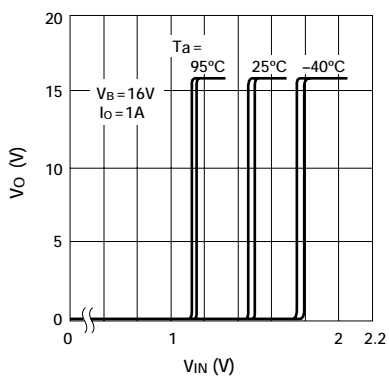

■ Input Current (Output ON)

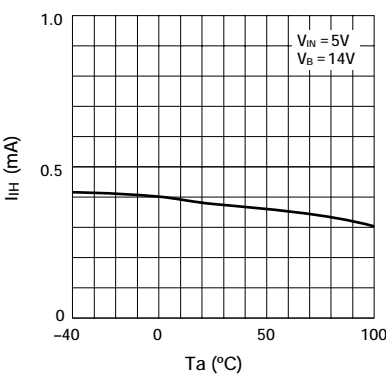

■ Input Current (Output OFF)

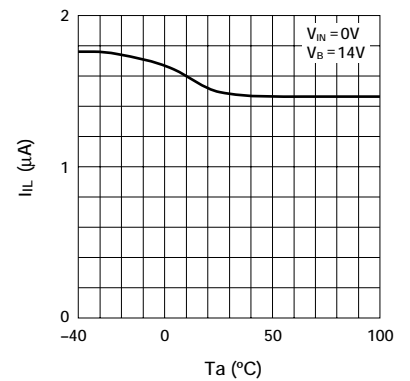

■ Saturation Voltage of DIAG Output

