

Absolute maximum ratings

($T_a=25^\circ\text{C}$)

Symbol	Ratings		Unit
	NPN	PNP	
V_{CBO}	60 ± 10	-60	V
V_{CEO}	60 ± 10	-60	V
V_{EBO}	6	-6	V
I_{CP}	1.5	-3	A
I_B	0.5	-0.5	A
P_T	4 ($T_a=25^\circ\text{C}$)		W
	20 ($T_c=25^\circ\text{C}$)		
T_j	150		$^\circ\text{C}$
T_{stg}	-40 to +150		$^\circ\text{C}$

Equivalent circuit diagram

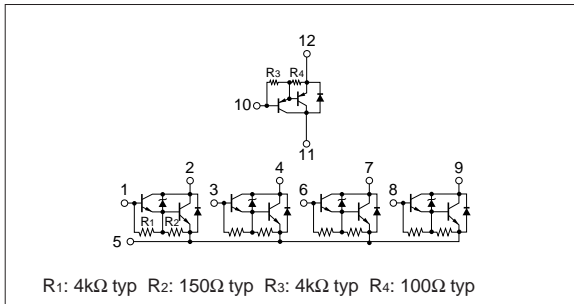

Characteristic curves

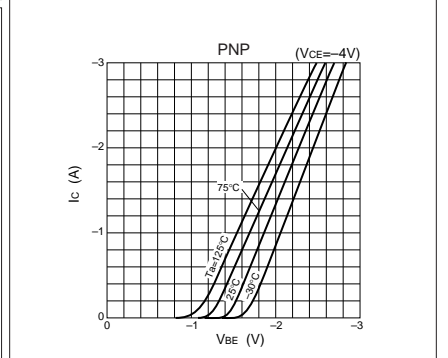
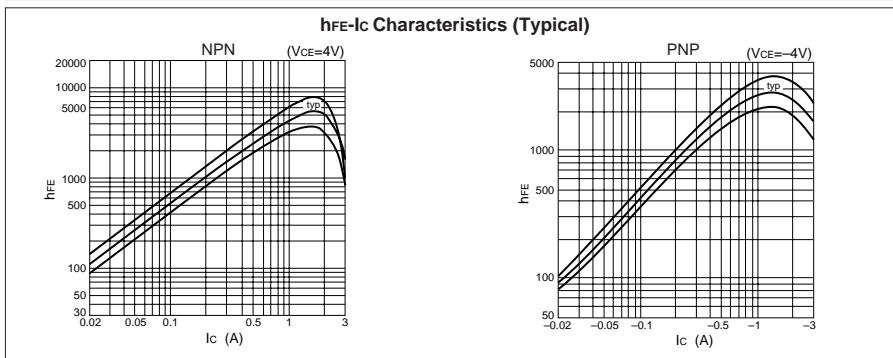
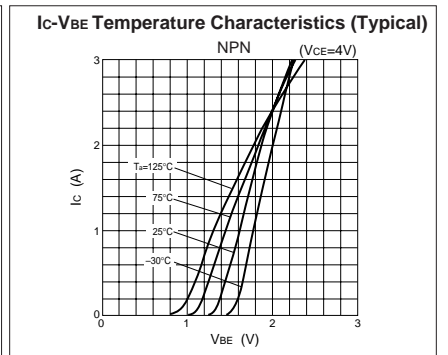
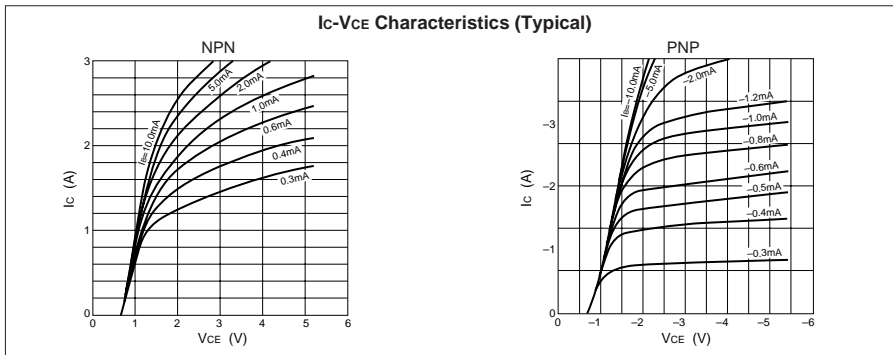

Electrical characteristics

($T_a=25^\circ\text{C}$)

Symbol	NPN					PNP				
	Specification			Unit	Conditions	Specification			Unit	Conditions
	min	typ	max			min	typ	max		
I_{CBO}			10	μA	$V_{CB}=50\text{V}$			-10	μA	$V_{CB}=-60\text{V}$
I_{EBO}			5	mA	$V_{EB}=6\text{V}$			-5	mA	$V_{EB}=-6\text{V}$
V_{CEO}	50	60	70	V	$I_C=10\text{mA}$	-60			V	$I_C=-10\text{mA}$
h_{FE}	2000				$V_{CE}=4\text{V}, I_C=1\text{A}$	2000				$V_{CE}=-4\text{V}, I_C=-1\text{A}$
$V_{CE}(\text{sat})$			1.5	V	$I_C=1\text{A}, I_B=2\text{mA}$			-1.5	V	$I_C=-1\text{A}, I_B=-2\text{mA}$

Characteristic curves

