

Silicon NPN Epitaxial Planar Transistor (Complement to type 2SA1294)

Application : Audio and General Purpose

Absolute maximum ratings (Ta=25°C)

| Symbol | 2SC3263 | Unit |
|------------------|---------------------------|------|
| V _{CB0} | 230 | V |
| V _{CEO} | 230 | V |
| V _{EBO} | 5 | V |
| I _C | 15 | A |
| I _B | 4 | A |
| P _C | 130(T _C =25°C) | W |
| T _J | 150 | °C |
| T _{stg} | -55 to +150 | °C |

Electrical Characteristics (Ta=25°C)

| Symbol | Conditions | 2SC3263 | Unit |
|----------------------|---|---------|------|
| I _{CB0} | V _{CB} =230V | 100max | μA |
| I _{EBO} | V _{EB} =5V | 100max | μA |
| V _{(BR)CEO} | I _C =25mA | 230min | V |
| h _{FE} | V _{CE} =4V, I _C =5A | 50min* | |
| V _{CE(sat)} | I _C =5A, I _B =0.5A | 2.0max | V |
| f _r | V _{CE} =12V, I _E =-2A | 60typ | MHz |
| COB | V _{CB} =10V, f=1MHz | 250typ | pF |

*h_{FE} Rank \bar{O} (50 to 100), Y(70 to 140)

Typical Switching Characteristics (Common Emitter)

| V _{CC} (V) | R _L (Ω) | I _C (A) | V _{BB1} (V) | V _{BB2} (V) | I _{B1} (mA) | I _{B2} (mA) | t _{on} (μs) | t _{stg} (μs) | t _f (μs) |
|---------------------|--------------------|--------------------|----------------------|----------------------|----------------------|----------------------|----------------------|-----------------------|---------------------|
| 60 | 12 | 5 | 10 | -5 | 500 | -500 | 0.30typ | 2.40typ | 0.50typ |

External Dimensions MT-100(TO3P)

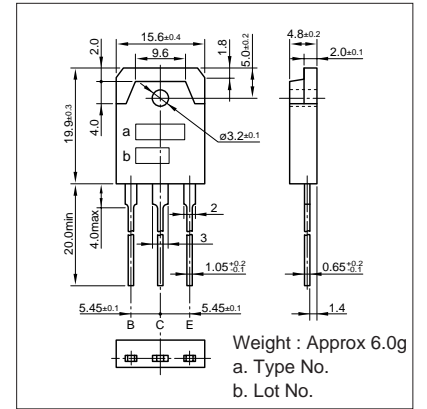

I_C-V_{CE} Characteristics (Typical)

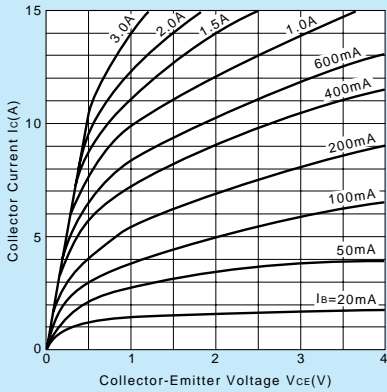

V_{CE(sat)}-I_B Characteristics (Typical)

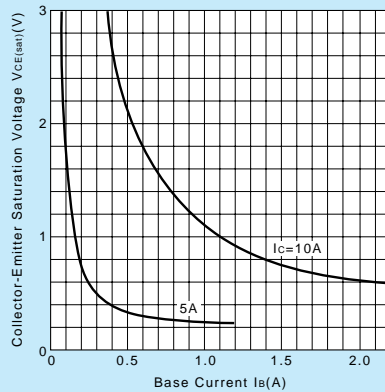

I_C-V_{BE} Temperature Characteristics (Typical)

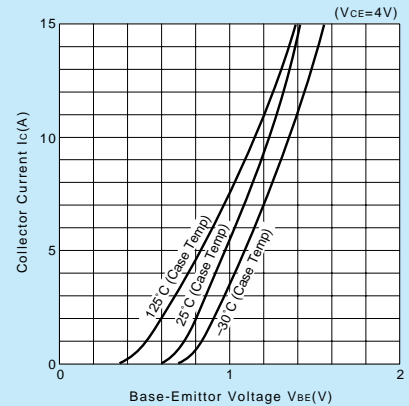

h_{FE}-I_C Characteristics (Typical)

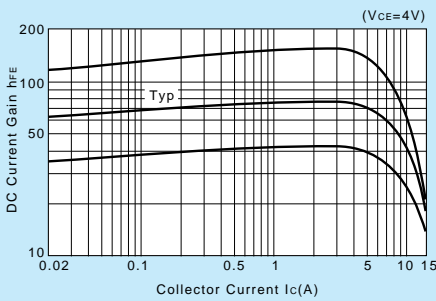

h_{FE}-I_C Temperature Characteristics (Typical)

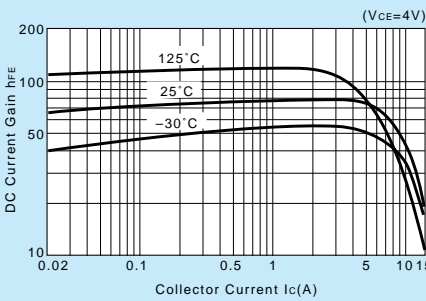

θ_{J-a}-t Characteristics

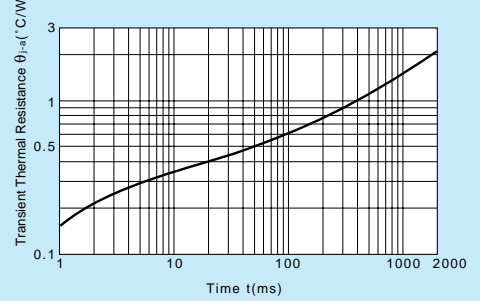

f_T-I_E Characteristics (Typical)

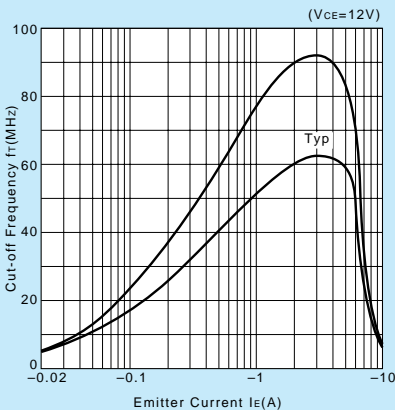

Safe Operating Area (Single Pulse)

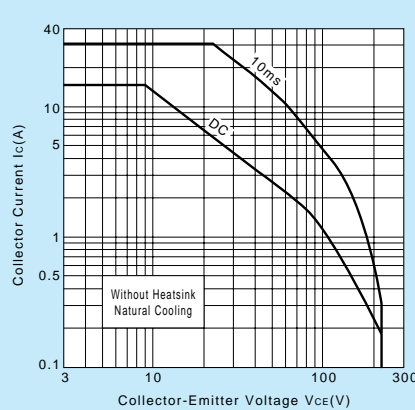

P_C-T_a Derating

