

2SC4883/4883A

Silicon NPN Epitaxial Planar Transistor (Complement to type 2SA1859/A)

Application : Audio Output Driver and TV Velocity-modulation

Absolute maximum ratings (Ta=25°C)

Symbol	2SC4883	2SC4883A	Unit
V _{CBO}	150	180	V
V _{CEO}	150	180	V
V _{EBO}	6		V
I _C	2		A
I _B	1		A
P _C	20(Tc=25°C)		W
T _j	150		°C
T _{stg}	-55 to +150		°C

Electrical Characteristics (Ta=25°C)

Symbol	Conditions	2SC4883	2SC4883A	Unit
I _{CBO}	V _{CB} =	150	180	μA
I _{EBO}	V _{EB} =6V	10max		μA
V _{(BR)CEO}	I _C =10mA	150min	180min	V
h _{FE}	V _{CE} =10V, I _C =0.7A	60to240		
V _{CE(sat)}	I _C =0.7A, I _B =70mA	1.0max		V
f _T	V _{CE} =12V, I _E =-0.7A	120typ		MHz
C _{OB}	V _{CB} =10V, f=1MHz	30typ		pF

Typical Switching Characteristics (Common Emitter)

V _{CC} (V)	R _L (Ω)	I _C (A)	V _{BB1} (V)	V _{BB2} (V)	I _{B1} (mA)	I _{B2} (mA)	t _{on} (μs)	t _{stg} (μs)	t _f (μs)
20	20	1	10	-5	100	-100	0.5typ	1.5typ	0.5typ

External Dimensions FM20(TO220F)

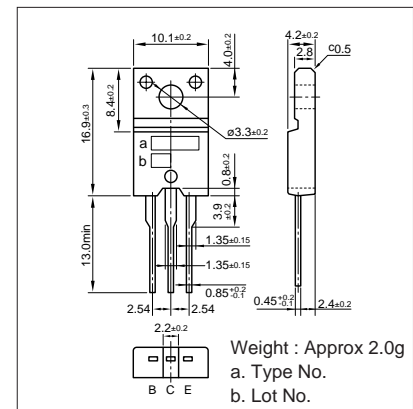

I_C-V_{CE} Characteristics (Typical)

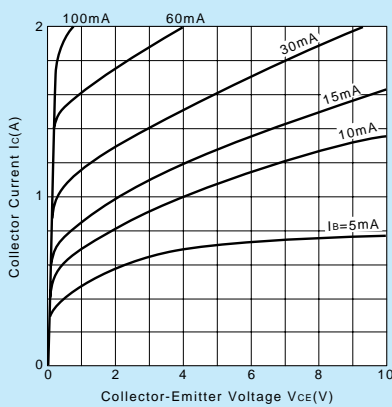

V_{CE(sat)}-I_B Characteristics (Typical)

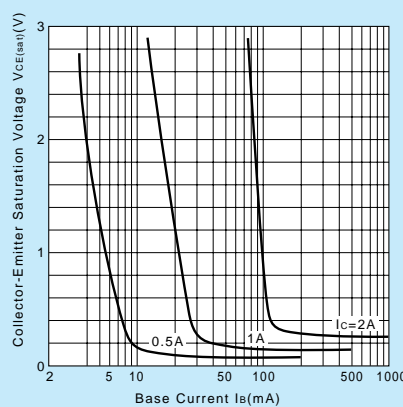

I_C-V_{BE} Temperature Characteristics (Typical)

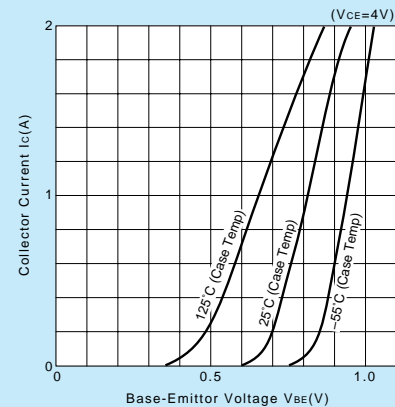

h_{FE}-I_C Characteristics (Typical)

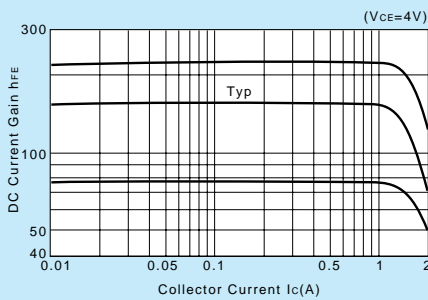

h_{FE}-I_C Temperature Characteristics (Typical)

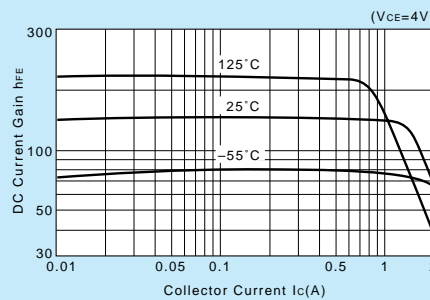

θ_{j-a}-t Characteristics

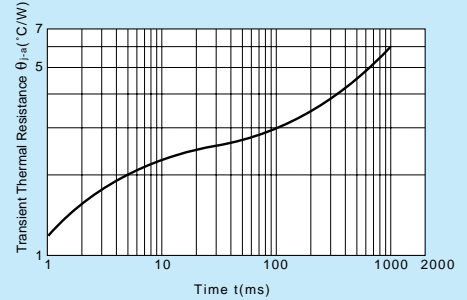

f_T-I_E Characteristics (Typical)

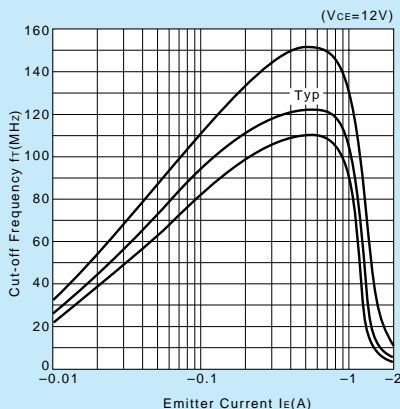

Safe Operating Area (Single Pulse)

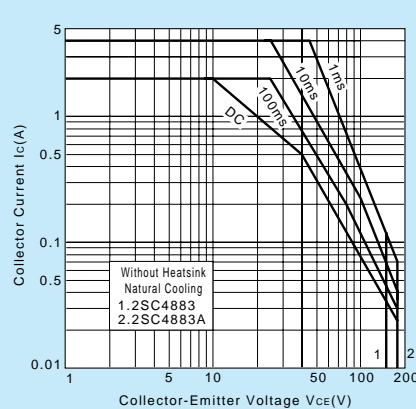

P_C-T_a Derating

