

Darlington 2SD2558

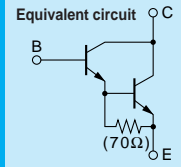

Silicon NPN Triple Diffused Planar Transistor

Application : Series Regulator and General Purpose

Absolute maximum ratings (Ta=25°C)

Symbol	2SD2558	Unit
V _{CB0}	200	V
V _{CE0}	200	V
V _{EB0}	6	V
I _C	5	A
I _B	2	A
P _C	60(T _C =25°C)	W
T _J	150	°C
T _{stg}	-55 to +150	°C

Electrical Characteristics (Ta=25°C)

Symbol	Conditions	2SD2558	Unit
I _{CB0}	V _{CB} =200V	100max	μA
I _{EB0}	V _{EB} =6V	5max	mA
V _{(BR)CEO}	I _C =10mA	200min	V
h _{FE}	V _{CE} =5V, I _C =1A	1500 to 6500	
V _{CE(sat)}	I _C =1A, I _B =5mA	1.5max	V
f _r	V _{CE} =10V, I _E =-0.5A	15typ	MHZ
COB	V _{CB} =10V, f=1MHz	110typ	pF

External Dimensions FM100(TO3PF)

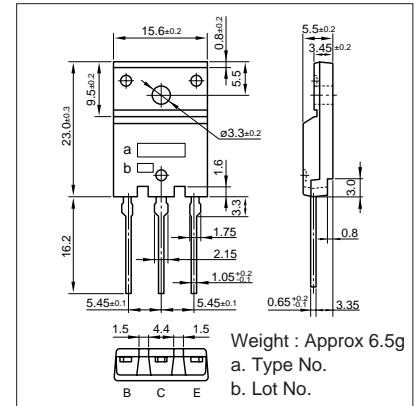

I_C-V_{CE} Characteristics (Typical)

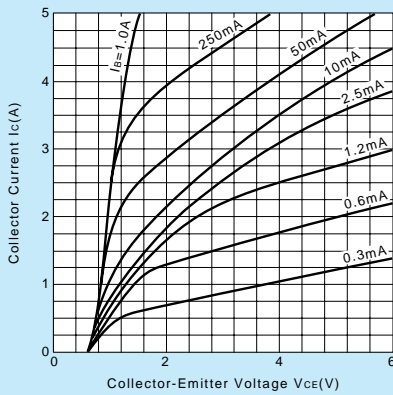

V_{CE(sat)}-I_B Characteristics (Typical)

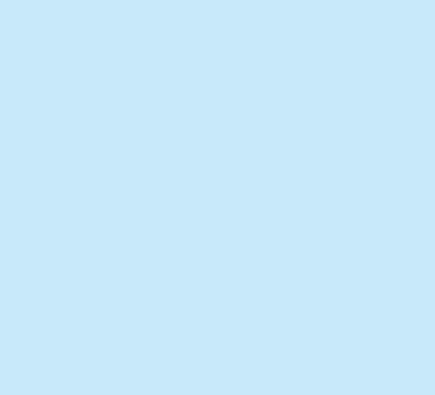

I_C-V_{BE} Temperature Characteristics (Typical)

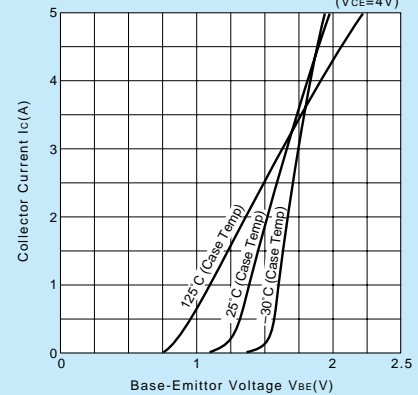

h_{FE}-I_C Characteristics (Typical)

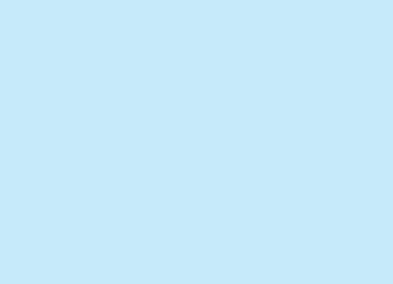

h_{FE}-I_C Temperature Characteristics (Typical)

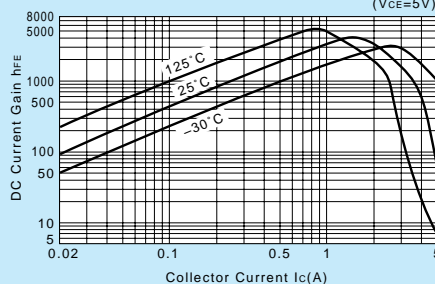

θ_{j-a}-t Characteristics

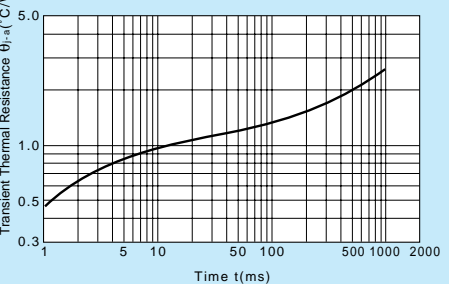

f_T-I_E Characteristics (Typical)

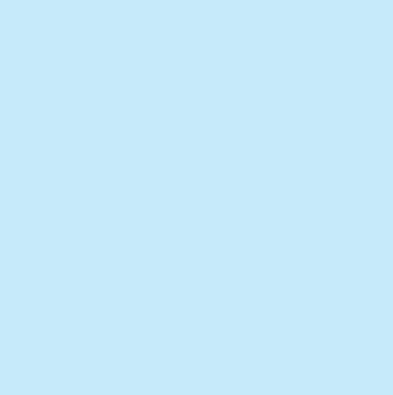

Safe Operating Area (Single Pulse)

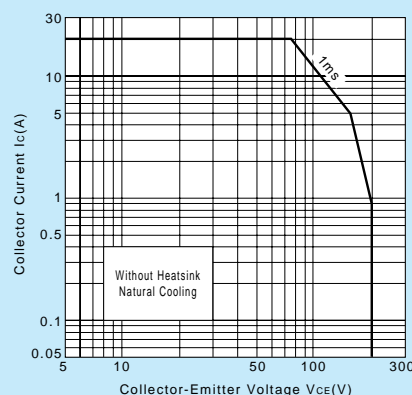

P_C-T_a Derating

