

# Damper Diodes (For Display)

Parameter Type No.	Absolute Maximum Ratings					Electrical Characteristics (Ta=25°C)							Others					
	V <sub>RM</sub> (V)	I <sub>F(AV)</sub> (A)	I <sub>FSM</sub> (A) 50Hz Half-cycle Sinewave Single Shot	T <sub>J</sub> (°C)	T <sub>stg</sub> (°C)	V <sub>F</sub> (V)		I <sub>R</sub> (μA)	I <sub>R</sub> (H) (μA) V <sub>R</sub> =V <sub>RM</sub> Ta=100°C max	t <sub>rr</sub> (1) (μs)	t <sub>rr</sub> (2) (μs)	R <sub>th(j-ℓ)</sub> (°C/W)	Mass (g)	Fig.	Remarks			
						max	I <sub>F</sub> (A)									I <sub>F</sub> /I <sub>RP</sub> (mA)	I <sub>F</sub> /I <sub>RP</sub> (mA)	
FMP-G2FS	1500	5.0	50	-40 to +150		2.0	5.0	50	500 (T <sub>J</sub> =150°C)	0.7	500/500	0.3	4.0	2.1	Ⓐ			
FMQ-G2FLS						1.8											1.2	
FMQ-G2FS						2.8												
FMQ-G5FMS		10.0				2.4											0.5	
FMQ-G5GS	1700					2.7		100				2.0	6.5	Ⓑ				
FMP-G5HS	1800	8.0				2.0	8.0		25			0.4						
RG 2A2	1300	0.5	5	-40 to +150		3.5	0.5	100	500	0.1	100/100	0.05	12.0	0.6	Ⓒ	For Compensation		
RC 3B2	1600	1.0	20			3.6	1.0										0.07	500/500

## FMP-G2FS

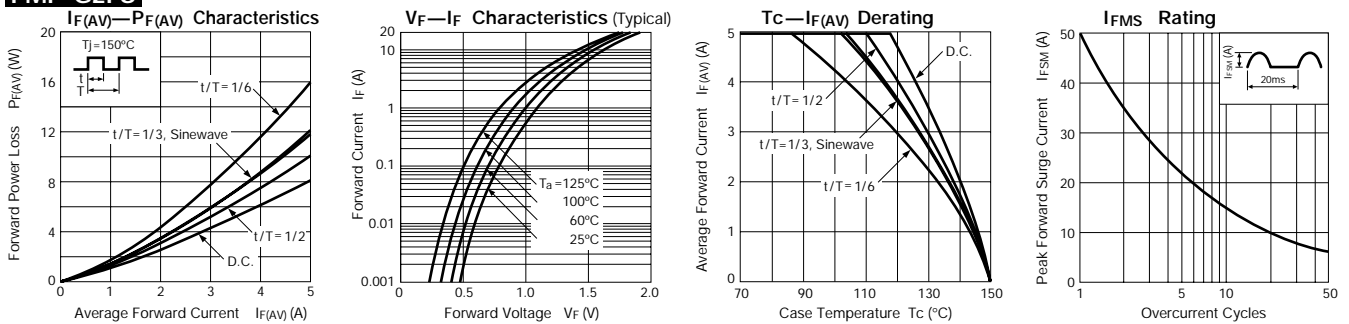

## FMQ-G2FLS

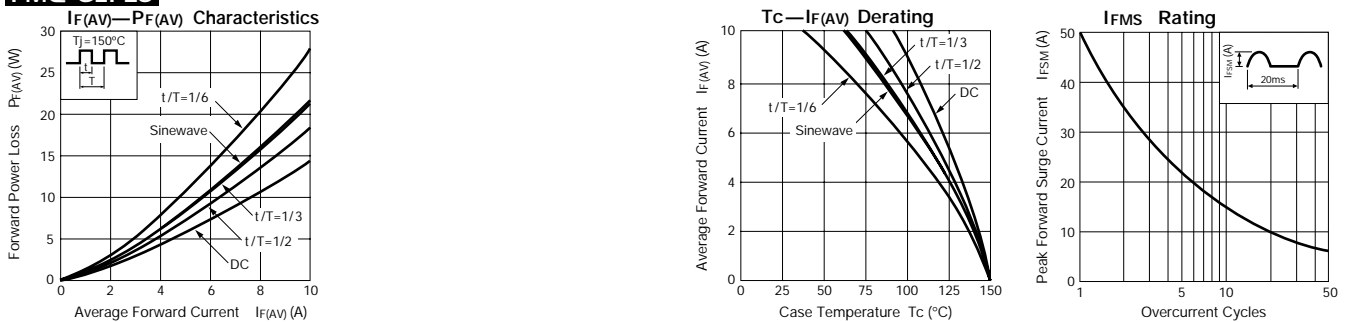

## FMQ-G2FS

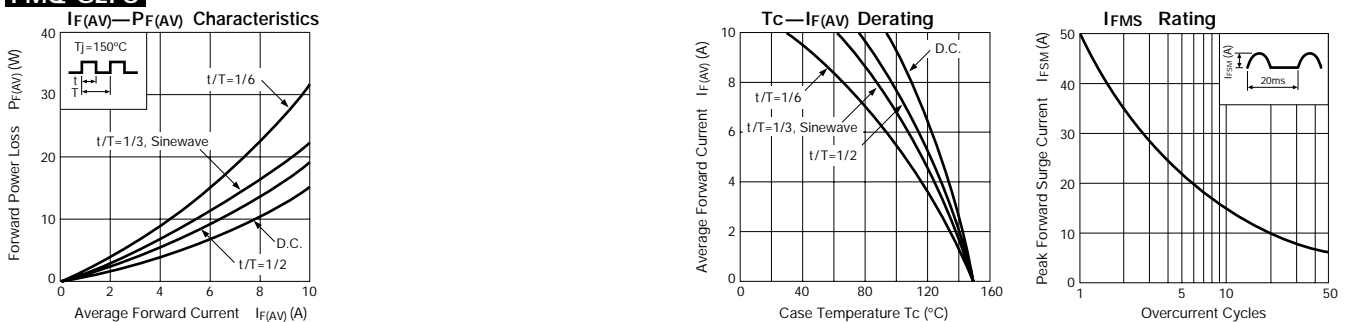

## External Dimensions

(Unit: mm) (Full-mold)

Flammability:  
UL94V-0 or Equivalent

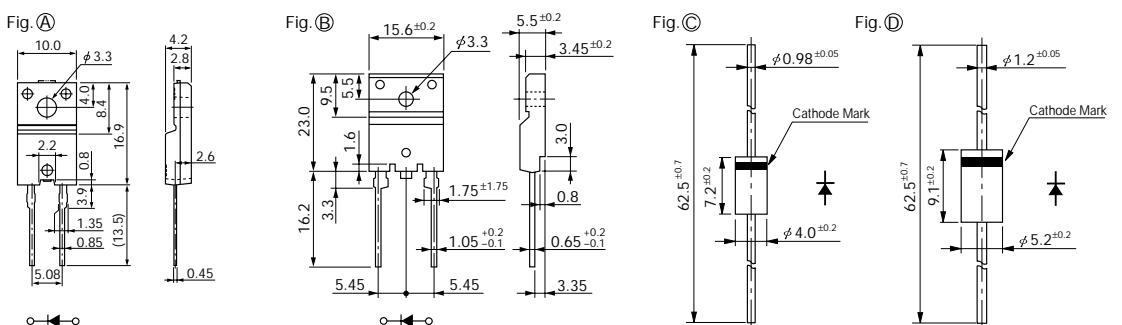

**FMQ-G5FMS**

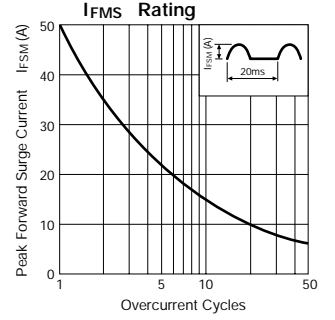
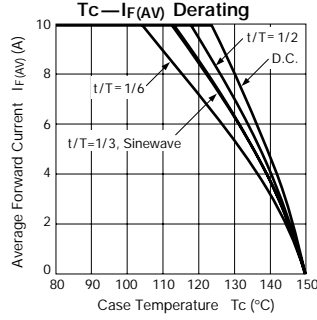
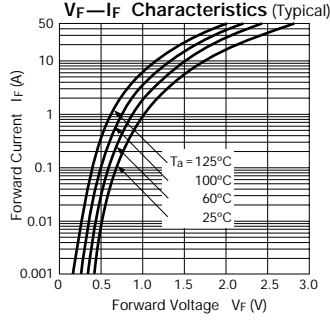
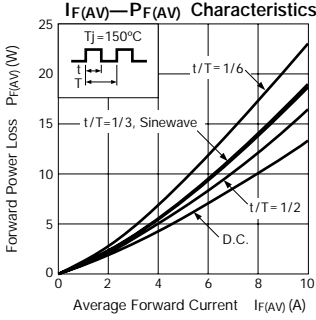

**FMQ-G5GS**

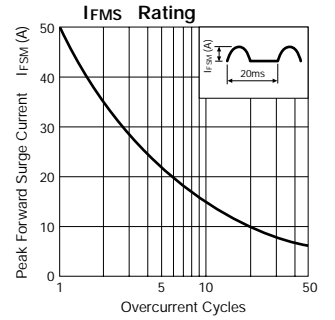
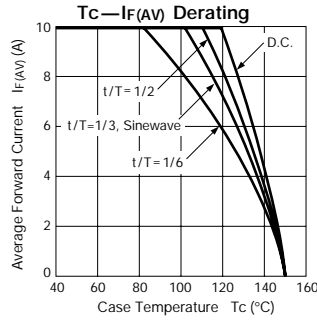
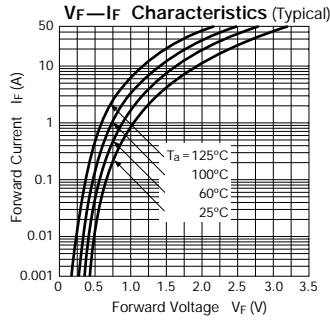
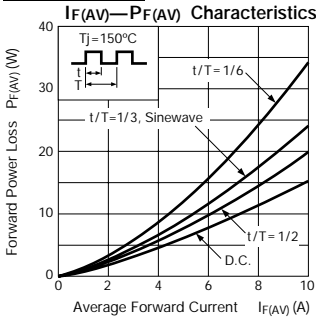

**FMP-G5HS**

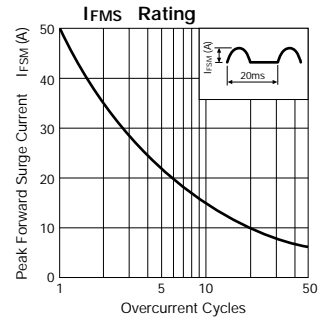
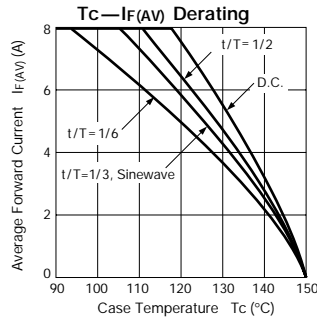
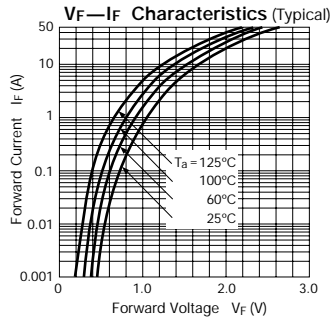
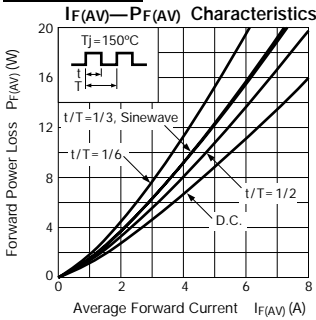

**RG 2A2**

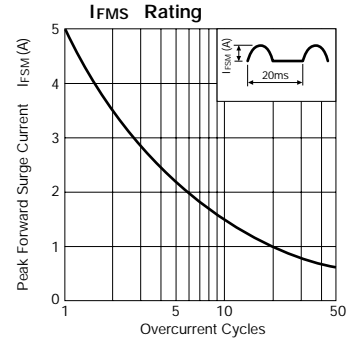
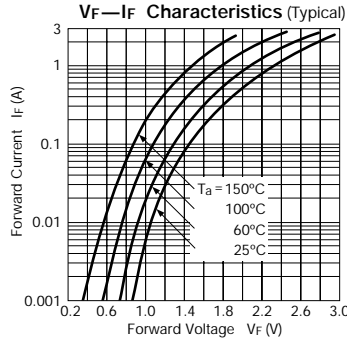
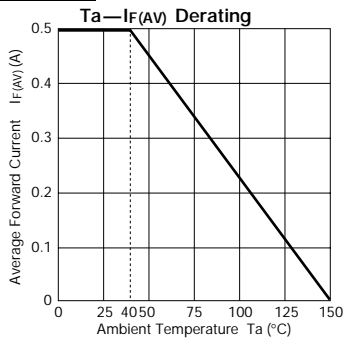

**RC 3B2**

