

Schottky Barrier Diodes (Power Surface Mount) 30V, 40V, 60V

| Parameter Type No. | Absolute Maximum Ratings | | | | | Electrical Characteristics (Ta=25°C) | | | | | | Others | | |
|-----------------------|--------------------------|------------------------|---|---------------------|-----------------------|---------------------------------------|---------------------|---|----------------------|-----------------------------|----------|---------|------------|---|
| | V _{RM} (V) | I _{F(AV)} (A) | I _{FSM} (A) 50Hz Half-cycle Sinewave Single Shot | T _J (°C) | T _{stg} (°C) | V _F (V) max per element | I _R (mA) | I _{R(H)} (mA) V _R =V _{RM} , Ta=100°C max per element | t _{rr} (ns) | R _{th(j-c)} (°C/W) | Mass (g) | Remarks | Fig. | |
| SPJ-63S | 30 | 6.0 | 50 | -40 to +150 | 0.45 | 3.0 | 3.0 | 30 (T _J =125°C) | — | — | 5.0 | 0.29 | Center-tap | Ⓐ |
| SPB-64S | | 6.0 | | | | | | | | | | | | |
| SPB-G34S | | 3.0 | | | | | | | | | | | | |
| SPB-G54S | | 5.0 | | | | | | | | | | | | |
| MPE-24H | | 15.0 | | | | | | | | | | | | |
| SPB-G56S | 60 | 6.0 | 60 | 0.7 | 5.0 | 3.0 | 50 | 50 | 100/100 | 5.0 | 0.29 | 1 Chip | Ⓐ | |

SPJ-63S

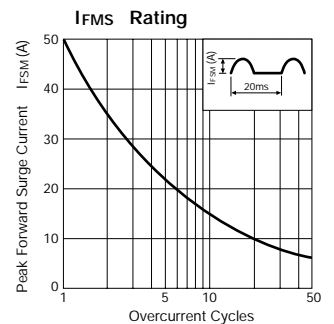

SPB-64S

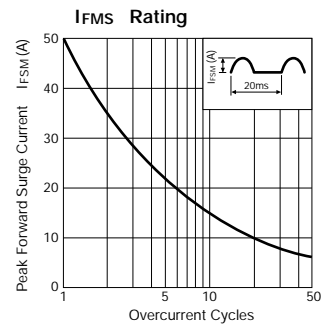
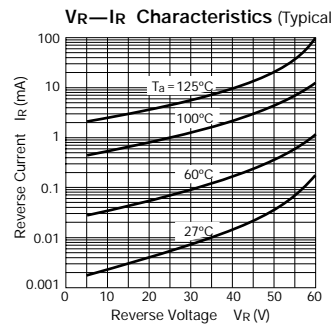
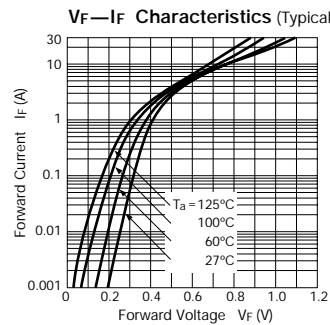
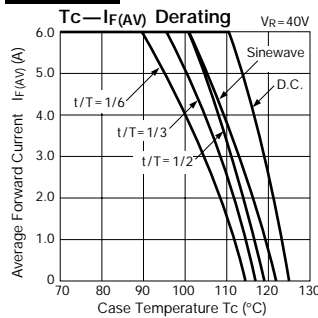

SPB-G34S

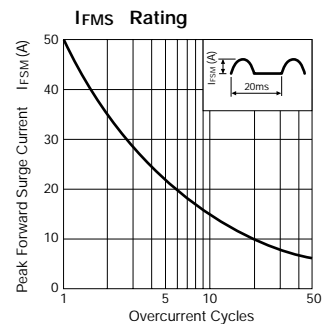
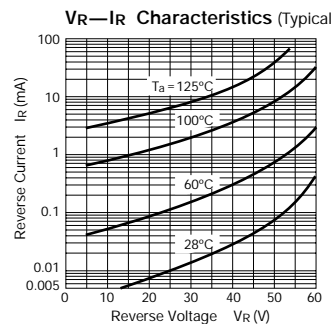
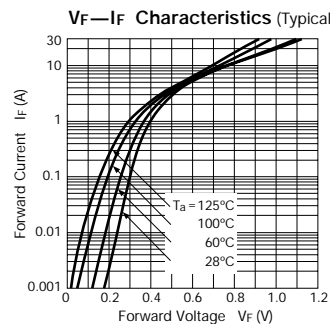
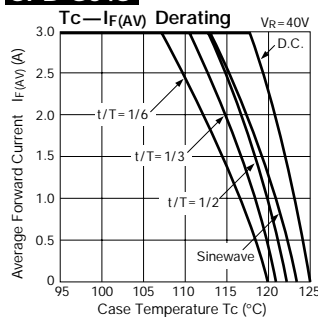

External Dimensions (Unit: mm)

Flammability:
UL94V-0 or Equivalent

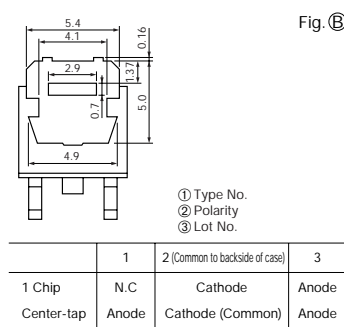
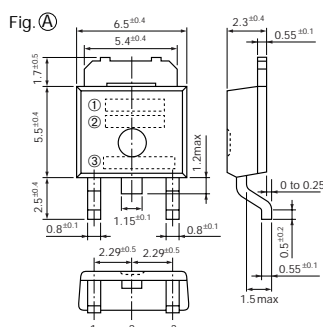

- ① Type No.
- ② Polarity
- ③ Lot No.

| | | | |
|------------|-------|--------------------------------|-------|
| | 1 | 2 (Common to backside of case) | 3 |
| 1 Chip | N.C | Cathode | Anode |
| Center-tap | Anode | Cathode (Common) | Anode |

SPB-G54S

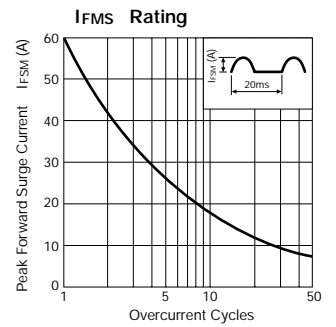
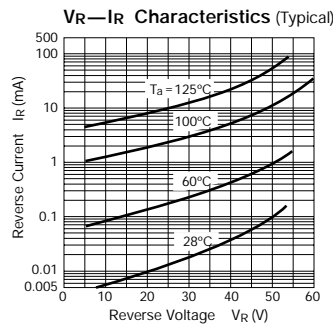
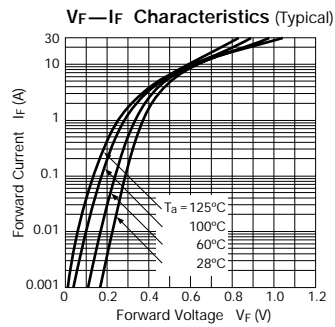
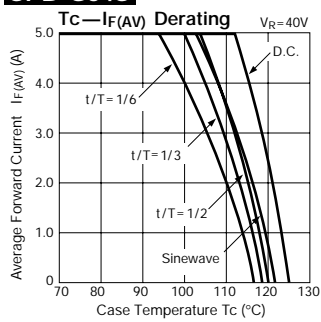

MPE-24H

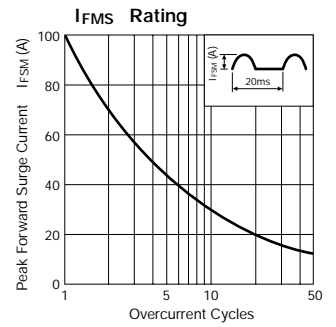
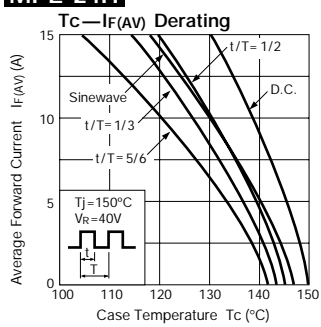

SPB-G56S

