

# Schottky Barrier Diodes (Surface Mount) 60V, 90V

Parameter Type No.	Absolute Maximum Ratings					Electrical Characteristics (Ta=25°C)					Others						
	VRM (V)	IF(AV) (A)	IFSM (A) 50Hz Half-cycle Sinewave Single Shot	Tj (°C)	Tstg (°C)	VF (V)		IR (mA)	IR (H) (mA)	trr (ns)	Rth(j-ℓ) (°C/W)	Mass (g)	Fig.				
						max	IF (A)	VR=VRM max	VR=VRM Ta=100°C max								
SFPB-56	60	0.7	10	-40 to +150	0.62	0.7	1.00	7.5	100	100/100	20.0	0.072	A				
SFPB-66		2.0	25														
SFPB-76		2.0	40														
SFPB-59	90	0.7	10											0.81	0.7	1.00	5
SFPB-69 *		1.5	40														

\* Under development

## SFPB-56

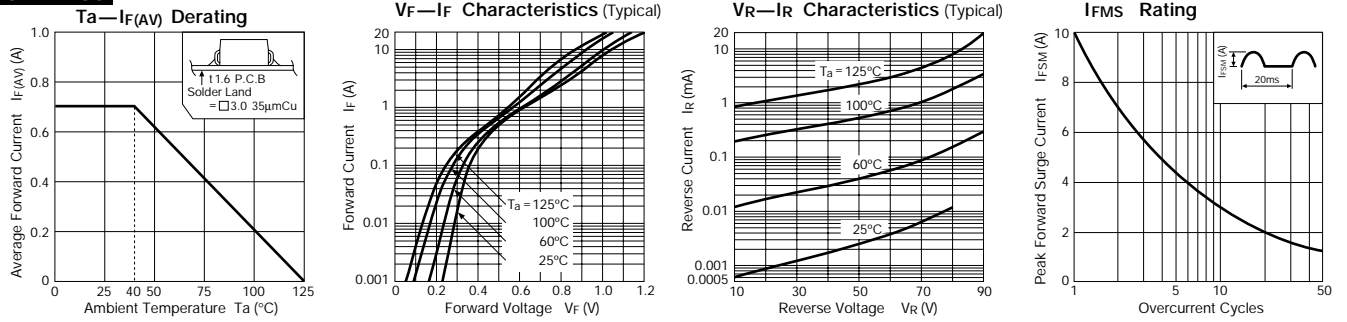

## SFPB-66

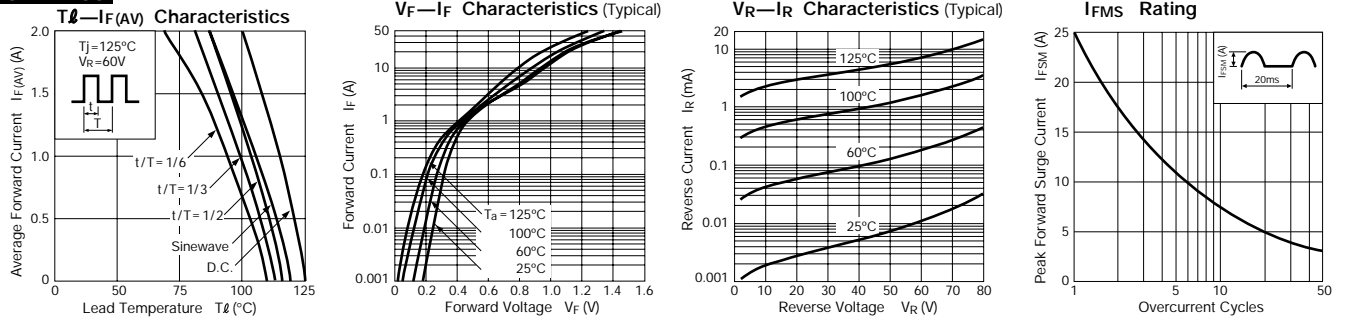

## SFPB-76

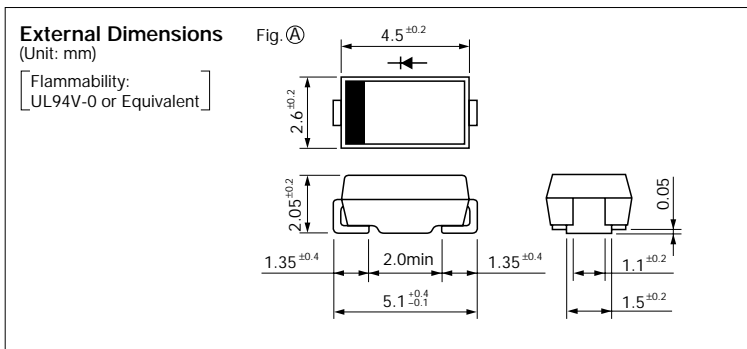
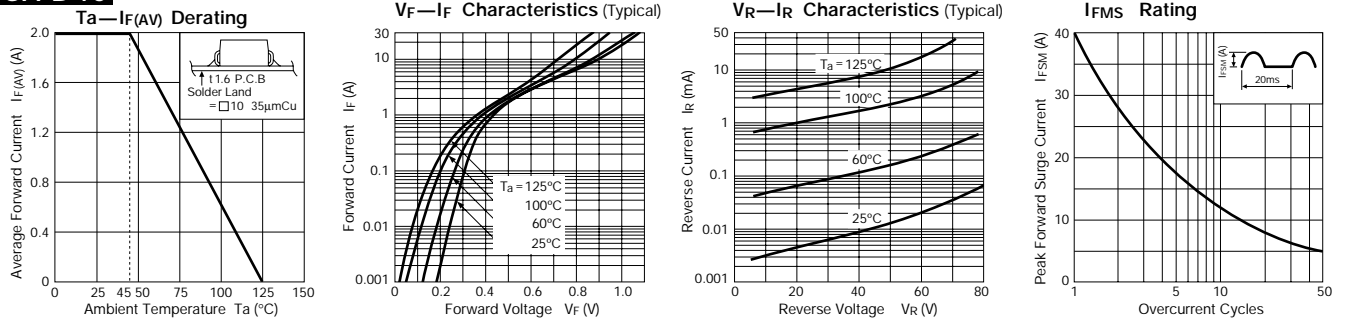

**SFPB-59**

**Ta—If(AV) Derating**

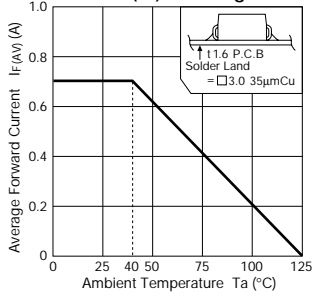

**V<sub>F</sub>—I<sub>F</sub> Characteristics (Typical)**

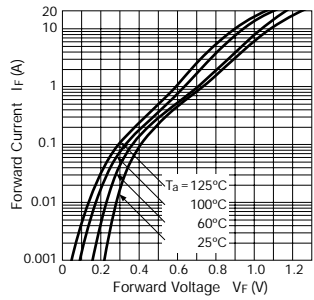

**V<sub>R</sub>—I<sub>R</sub> Characteristics (Typical)**

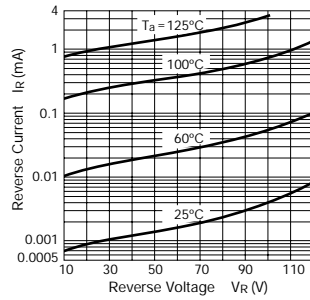

**I<sub>FMS</sub> Rating**

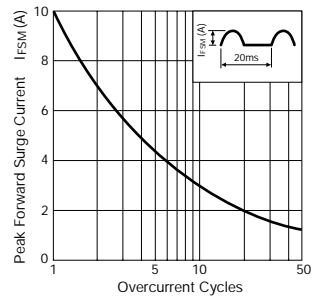

**SFPB-69**

**T<sub>l</sub>—I<sub>F(AV)</sub> Characteristics**

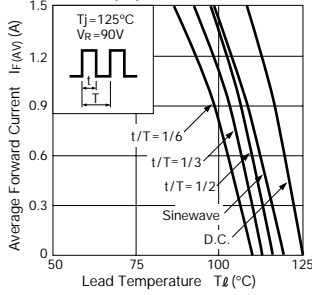

**V<sub>F</sub>—I<sub>F</sub> Characteristics (Typical)**

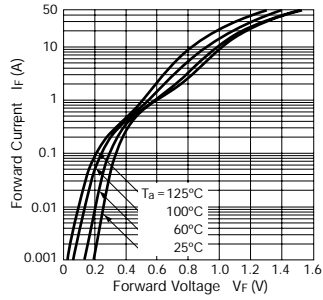

**V<sub>R</sub>—I<sub>R</sub> Characteristics (Typical)**

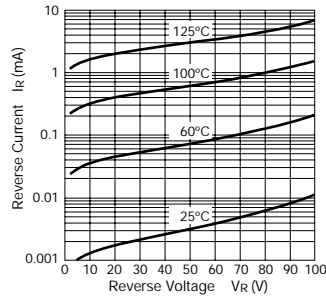

**I<sub>FMS</sub> Rating**

