

# DIODE MODULE

# DD(KD)30HB120/160



UL;E76102 (M)

Power Diode Module **DD30HB** series are designed for various rectifier circuits. **DD30HB** has two diode chips connected in series and the mounting base is electrically isolated from elements for simple heatsink construction. Wide voltage rating up to, 1,600V is available for various input voltage.

- Isolated mounting base
- Two elements in a package for simple (single and three phase) bridge connections
- Highly reliable glass passivated chips
- High surge current capability

### (Applications)

Various rectifiers, Battery chargers, DC motor drives

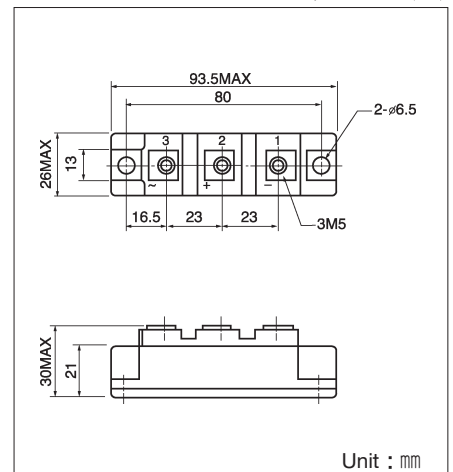
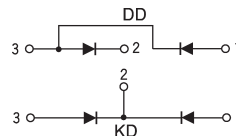

## Maximum Ratings

(T<sub>j</sub>=25°C)

Symbol	Item	Ratings		Unit
		DD30HB120	DD30HB160	
V <sub>RRM</sub>	Repetitive Peak Reverse Voltage	1200	1600	V
V <sub>RSM</sub>	Non-Repetitive Peak Reverse Voltage	1350	1700	V

Symbol	Item	Conditions	Ratings	Unit	
I <sub>F(AV)</sub>	Average Forward Current	Single phase, half wave, 180° conduction, T <sub>c</sub> : 115°C	30	A	
I <sub>F(RMS)</sub>	R.M.S. Forward Current	Single phase, half wave, 180° conduction, T <sub>c</sub> : 115°C	47	A	
I <sub>FSM</sub>	Surge Forward Current	1/2 cycle, 50/60Hz, peak value, non-repetitive	550/600	A	
I <sup>2</sup> t	I <sup>2</sup> t	Value for one cycle of surge current	1500	A <sup>2</sup> S	
T <sub>j</sub>	Junction Temperature		-40~+150	°C	
T <sub>stg</sub>	Storage Temperature		-40~+125	°C	
V <sub>ISO</sub>	Isolation Breakdown Voltage (R.M.S.)	A.C.1minute	2500	V	
	Mounting Torque	Mounting (M6)	Recommended Value 2.5~3.9 (25~40)	4.7 (48)	N·m (kgf·cm)
		Terminal (M5)	Recommended Value 1.5~2.5 (15~25)	2.7 (28)	
	Mass		170	g	

## Electrical Characteristics

Symbol	Item	Conditions	Ratings	Unit
I <sub>RRM</sub>	Repetitive Peak Reverse Current, max.	at V <sub>DRM</sub> , single phase, half wave. T <sub>j</sub> =150°C	10	mA
V <sub>FM</sub>	Forward Voltage Drop, max.	Forward current 90A, T <sub>j</sub> =25°C, Inst. measurement	1.50	V
R <sub>th(j-c)</sub>	Thermal Impedance, max.	Junction to case	0.80	°C/W

**Maximum Forward Characteristics**

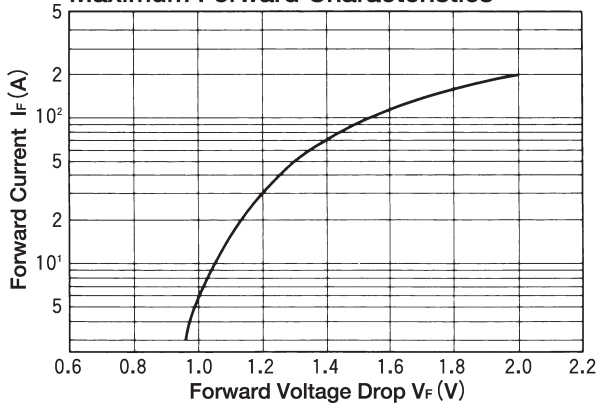

**Average Forward Current vs. Power Dissipation**

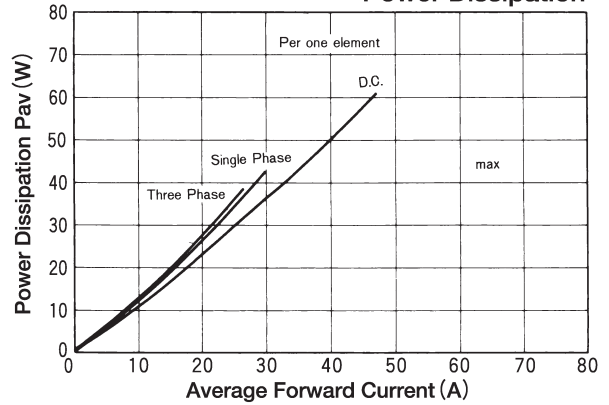

**Average Forward Current vs. Allowable Case Temperature**

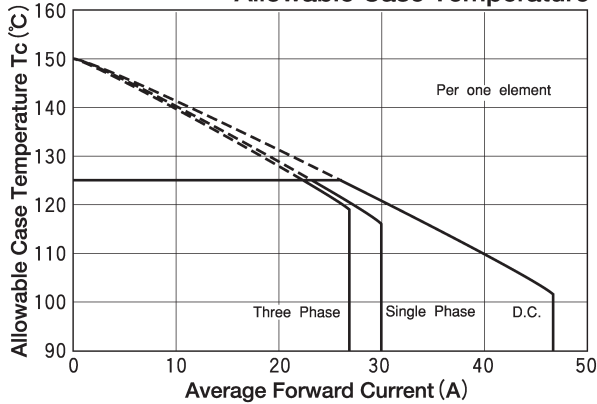

**Cycle Surge Forward Current Rating (Non-Repetitive)**

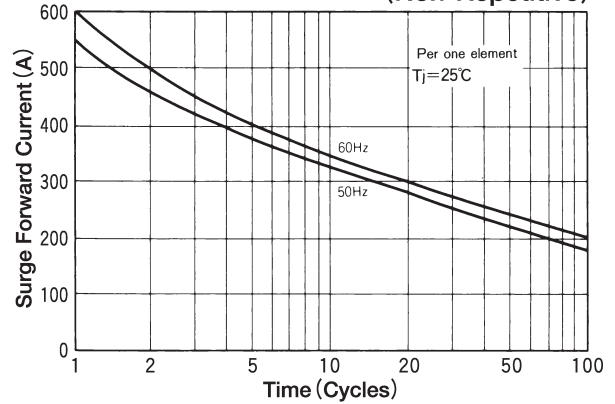

**Transient Thermal Impedance**

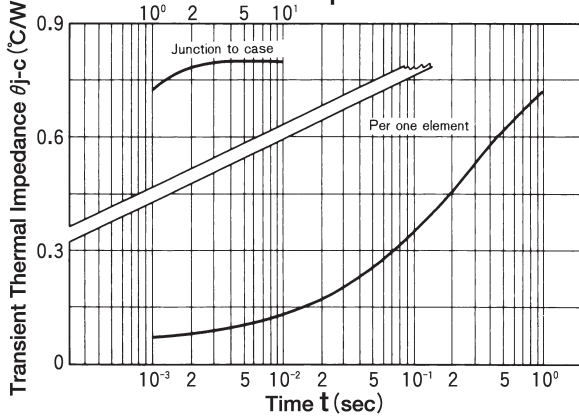

**B2; Two Pulse Bridge connection**

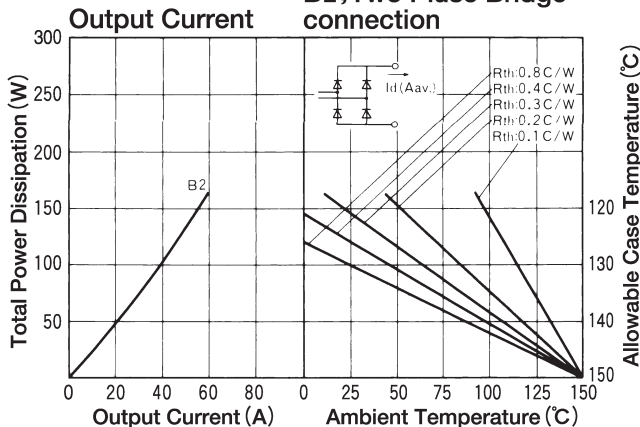

**B6; Six pulse Bridge connection**

