

THYRISTOR MODULE

PK(PD,PE)250HB



UL;E76102 (M)

Power Thyristor/Diode Module **PK250HB** series are designed for various rectifier circuits and power controls. For your circuit application, following internal connections and wide voltage ratings up to 1,600V are available.

Isolated mounting base

- $I_{T(AV)}$ 250A, $I_{T(RMS)}$ 310A, I_{TSM} 5500A
- di/dt 200 A/ μ s
- dv/dt 500V/ μ s

(Applications)

- Various rectifiers
- AC/DC motor drives
- Heater controls
- Light dimmers
- Static switches

Internal Configurations

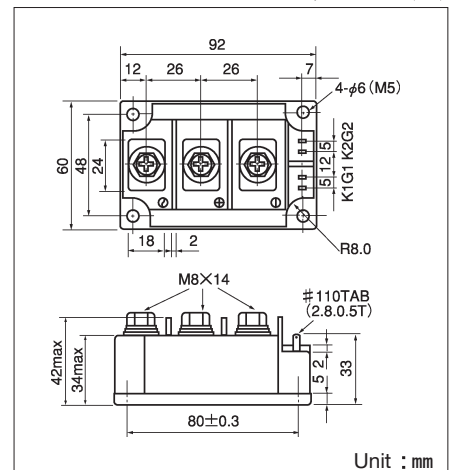
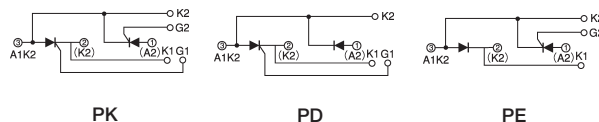

Maximum Ratings

Symbol	Item	Ratings				Unit
		PK250HB120 PE250HB120	PD250HB120	PK250HB160 PE250HB160	PD250HB160	
V_{RRM}	* Repetitive Peak Reverse Voltage		1200		1600	V
V_{RSM}	* Non-Repetitive Peak Reverse Voltage		1300		1700	V
V_{DRM}	Repetitive Peak Off-State Voltage		1200		1600	V

Symbol	Item	Conditions	Ratings	Unit	
$I_{T(AV)}$	* Average On-State Current	Single phase, half wave, 180° conduction, $T_c : 72^\circ\text{C}$	250	A	
$I_{T(RMS)}$	* R.M.S. On-State Current	Single phase, half wave, 180° conduction, $T_c : 72^\circ\text{C}$	390	A	
I_{TSM}	* Surge On-State Current	$1/2$ cycle, 50Hz/60Hz, peak Value, non-repetitive	5000/5500	A	
I^2t	* I^2t	Value for one cycle of surge current	125000	A ² S	
P_{GM}	Peak Gate Power Dissipation		10	W	
$P_{G(AV)}$	Average Gate Power Dissipation		3	W	
I_{FGM}	Peak Gate Current		3	A	
V_{FGM}	Peak Gate Voltage (Forward)		10	V	
V_{RGM}	Peak Gate Voltage (Reverse)		5	V	
di/dt	Critical Rate of Rise of On-State Current	$I_G = 100\text{mA}$, $T_j = 25^\circ\text{C}$, $V_D = 1/2 V_{DRM}$, $dI_G/dt = 0.1\text{A}/\mu\text{s}$	200	A/ μ s	
V_{ISO}	* Isolation Breakdown Voltage (R.M.S.)	A.C. 1 minute	2500	V	
T_j	* Operating Junction Temperature		-40 ~ +125	$^\circ\text{C}$	
T_{stg}	* Storage Temperature		-40 ~ +125	$^\circ\text{C}$	
	Mounting Torque	Mounting (M5)	Recommended Value 1.5~2.5 (15~25)	2.7 (28)	N·m (kgf·cm)
		Terminal (M8)	Recommended Value 8.8~10 (90~105)	11 (115)	
	Mass	Typical Value		510	g

Electrical Characteristics

Symbol	Item	Conditions	Ratings	Unit
I_{DRM}	Repetitive Peak Off-State Current, max.	at V_{DRM} , Single phase, half wave, $T_j = 125^\circ\text{C}$	50	mA
I_{RRM}	* Repetitive Peak Reverse Current, max.	at V_{DRM} , Single phase, half wave, $T_j = 125^\circ\text{C}$	50	mA
V_{TM}	* Peak On-State Voltage, max.	On-State Current 750A, $T_j = 125^\circ\text{C}$ Inst. measurement	1.60	V
I_{GT}/V_{GT}	Gate Trigger Current/Voltage, max.	$T_j = 25^\circ\text{C}$, $I_T = 1\text{A}$, $V_D = 6\text{V}$	100/3	mA/V
V_{GD}	Non-Trigger Gate, Voltage. min.	$T_j = 125^\circ\text{C}$, $V_D = 1/2 V_{DRM}$	0.25	V
t_{gt}	Turn On Time, max.	$I_T = 250\text{A}$, $I_G = 100\text{mA}$, $T_j = 25^\circ\text{C}$, $V_D = 1/2 V_{DRM}$, $dI_G/dt = 0.1\text{A}/\mu\text{s}$	10	μs
dv/dt	Critical Rate of Rise of Off-State Voltage, min.	$T_j = 125^\circ\text{C}$, $V_D = 2/3 V_{DRM}$, Exponential wave.	500	V/ μs
I_H	Holding Current, typ.	$T_j = 25^\circ\text{C}$	50	mA
I_L	Latching Current, typ.	$T_j = 25^\circ\text{C}$	100	mA
$R_{th(j-c)}$	* Thermal Impedance, max.	Junction to case	0.14	$^\circ\text{C}/\text{W}$

*mark : Thyristor and Diode part. No mark : Thyristor part

