

TRANSISTOR MODULE

SQD400AA100



UL;E76102 (M)

SQD400AA100 is a Darlington power transistor module with a high speed, high power Darlington transistor. The transistor has a reverse paralleled fast recovery diode. The mounting base of the module is electrically isolated from Semiconductor elements for simple heatsink construction.

- $I_C=400A$, $V_{CEX}=1000V$
- Low saturation voltage High DC current gain
- Isolated monuting base

(Applications)

Motor Control (VVF), AC/DC Servo, UPS, Switching Power Supply, Ultrasonic Application

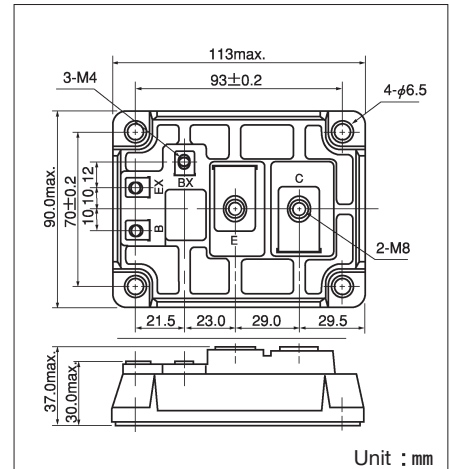
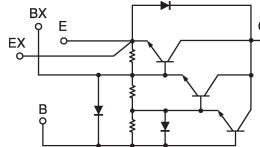

Maximum Ratings

($T_j=25^{\circ}C$)

Symbol	Item	Conditions	Ratings		Unit
			SQD400AA100		
V_{CBO}	Collector-Base Voltage		1000		V
V_{CEX}	Collector-Emitter Voltage	$V_{BE} = -2V$	1200		V
$V_{CEX(SUS)}$	Collector-Emitter Sustaning Voltage	$I_C = -80A, I_B = -18A$	1000		V
V_{EBO}	Emitterr-Base Voltage		10		V
I_C	Collector Current		400		A
$-I_C$	Reverse Collector Current		400		A
I_B	Base Current		20		A
P_T	Total power dissipation	$T_C = 25^{\circ}C$	3120		W
T_j	Junction Temperature		-40~+150		$^{\circ}C$
T_{stg}	Storage Temperature		-40~+125		$^{\circ}C$
V_{iso}	Isolation Voltage	A.C. 1minute	2500		V
	Mounting Torque	Mouting (M6)	Recommended Value 2.5~3.9 (25~40)	4.7 (48)	N·m (kgf·cm)
		Terminal (M8)	Recommended Value 8.8~10 (90~105)	11 (115)	
		Terminal (M4)	Recommended Value 1.0~1.4 (10~14)	1.5 (15)	
	Mass	Typical Value	670		g

Electrical Characteristics

($T_j=25^{\circ}C$)

Symbol	Item	Conditions	Ratings		Unit
			Min.	Max.	
I_{CBO}	Collector Cut-off Current	$V_{CB} = 1000V$		3.0	mA
I_{EBO}	Emitter Cut-off Current	$V_{EB} = 10V$		1000	mA
h_{FE}	DC Current Gain	$I_C = 300A, V_{CE} = 2.8V$	75		
		$I_C = 400A, V_{CE} = 5V$	100		
$V_{CE(sat)}$	Collector-Emitter Sturation Voltage	$I_C = 400A, I_B = 8A$		2.5	V
$V_{BE(sat)}$	Base-Emitter Saturation Voltage	$I_C = 400A, I_B = 8A$		3.5	V
t_{on}	Switching Time	On Time		3.0	μs
t_s		Storage Time	$V_{CC} = 600V, I_C = 400A$ $I_{B1} = 8A, I_{B2} = -8A$	16.0	
t_f		Fall Time		3.0	
V_{ECO}	$I_C = -400A$	Collector-Emitter Reverse Voltage		1.8	V
$R_{th(j-c)}$	Thermal Impedance (junction to case)	Transistor part		0.04	$^{\circ}C/W$
		Diode part		0.16	

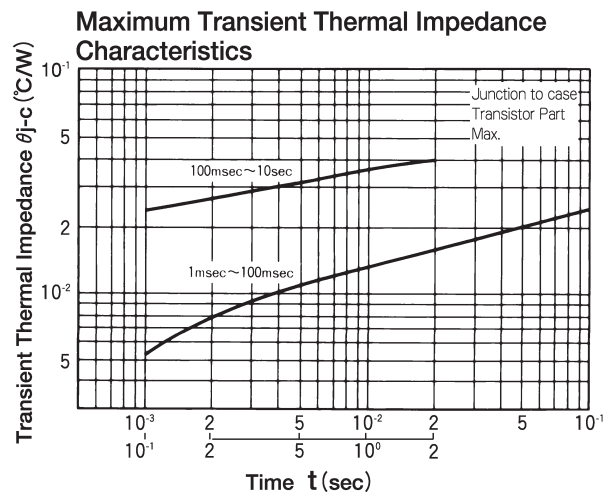
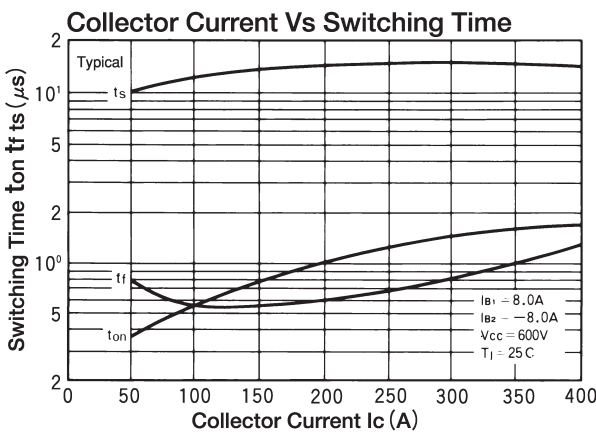
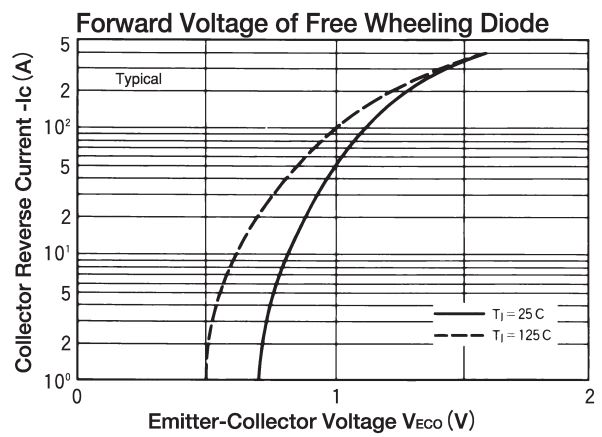
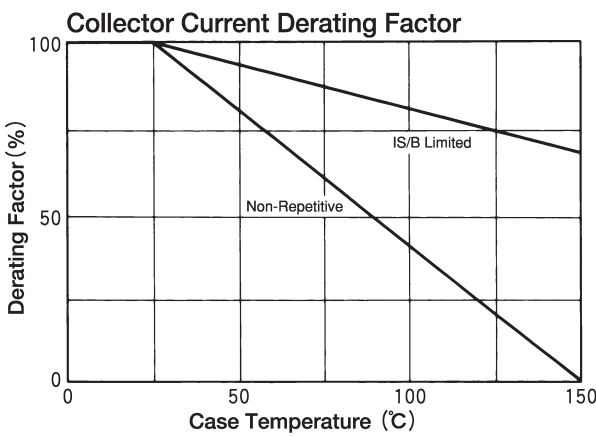
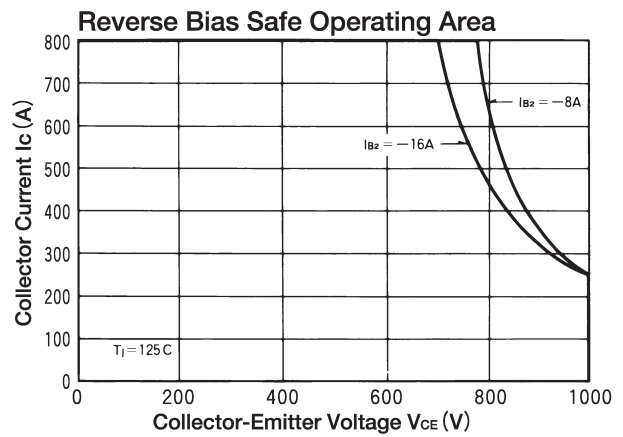
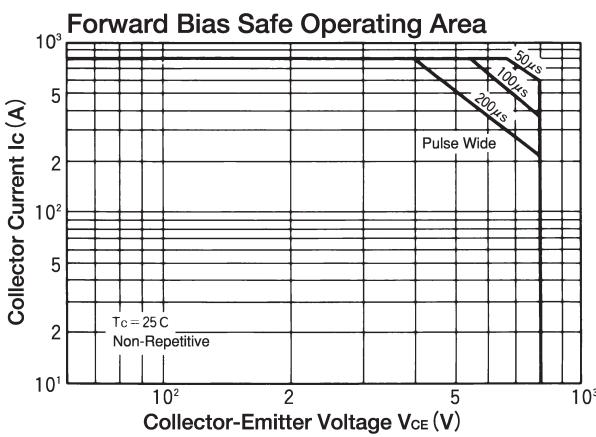
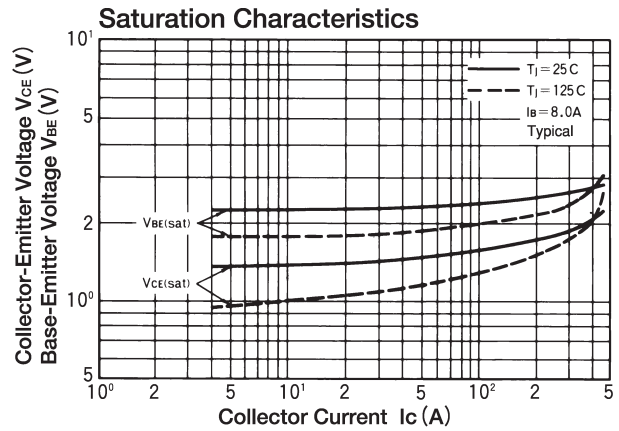
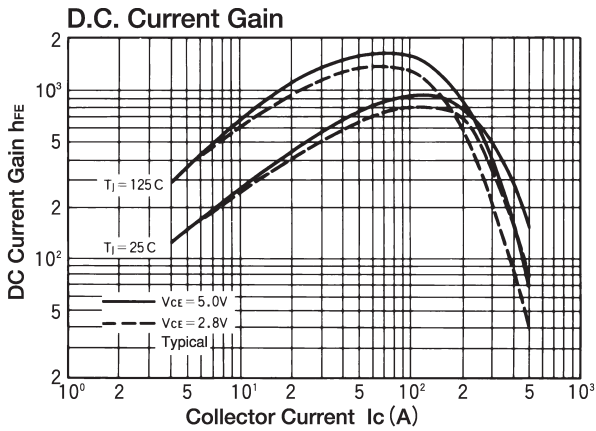

TRANSISTOR MODULE

SQD400AA120



UL;E76102 (M)

SQD400AA120 is a Darlington power transistor module with a high speed, high power Darlington transistor. The transistor has a reverse paralleled fast recovery diode. The mounting base of the module is electrically isolated from Semiconductor elements for simple heatsink construction.

- $I_C=400A$, $V_{CEX}=1200V$
- Low saturation voltage for higher efficiency
- High DC current gain.
- Isolated monuting base

(Applications)

Motor Control (VVVF), AC/DC Servo, UPS,
Switching Power Supply, Ultrasonic Application

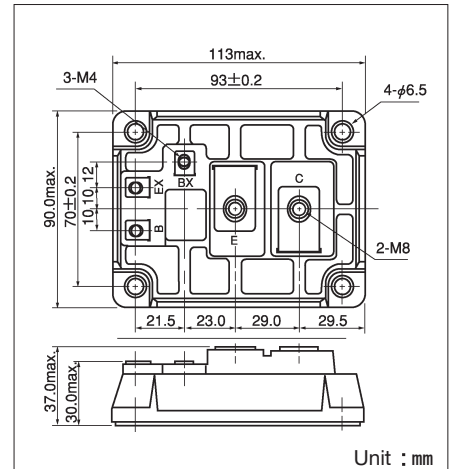
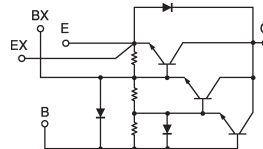

Unit : mm

Maximum Ratings

($T_j=25^{\circ}C$)

Symbol	Item	Conditions	Ratings		Unit
			SQD400AA120		
V_{CBO}	Collector-Base Voltage		1200		V
V_{CEX}	Collector-Emitter Voltage	$V_{BE} = -2V$	1200		V
$V_{CEX(SUS)}$	Collector-Emitter Sustaining Voltage	$I_C = 80A, I_{B2} = -18A$	1200		V
V_{EBO}	Emitterr-Base Voltage		10		V
I_C	Collector Current		400		A
$-I_C$	Reverse Collector Current		400		A
I_B	Base Current		20		A
P_T	Total power dissipation	$T_C = 25^{\circ}C$	3120		W
T_j	Junction Temperature		-40 ~ +150		$^{\circ}C$
T_{stg}	Storage Temperature		-40 ~ +125		$^{\circ}C$
V_{iso}	Isolation Voltage	A.C. 1minute	2500		V
	Mounting Torque	Mouting (M6)	Recommended Value 2.5~3.9 (25~40)	4.7 (48)	N·m (kgf·cm)
		Terminal (M8)	Recommended Value 8.8~10 (90~105)	11 (115)	
		Terminal (M4)	Recommended Value 1.0~1.4 (10~14)	1.5 (15)	
	Mass	Typical Value	670		g

Electrical Characteristics

($T_j=25^{\circ}C$)

Symbol	Item	Conditions	Ratings		Unit
			Min.	Max	
I_{CBO}	Collector Cut-off Current	$V_{CB} = 1200V$		5.00	mA
I_{EBO}	Emitter Cut-off Current	$V_{EB} = 10V$		1000	mA
h_{FE}	DC Current Gain	$I_C = 400A, V_{CE} = 2.8V$	75		
		$I_C = 400A, V_{CE} = 5V$	100		
$V_{CE(sat)}$	Collector-Emitter Sturation Voltage	$I_C = 400A, I_B = 8A$		3.0	V
$V_{BE(sat)}$	Base-Emitter Saturation Voltage	$I_C = 400A, I_B = 8A$		3.5	V
t_{on}	Switching Time	$V_{CC} = 600V, I_C = 400A$ $I_{B1} = 8A, I_{B2} = -8A$		3.0	μs
t_s			Storage Time	17.0	
t_f			Fall Time	3.0	
V_{ECO}	Collector-Emitter Reverse Voltage	$I_C = -400A$		1.8	V
$R_{th(j-c)}$	Thermal Impedance (junction to case)	Transistor part		0.04	$^{\circ}C/W$
		Diode part		0.16	

D.C. Current Gain

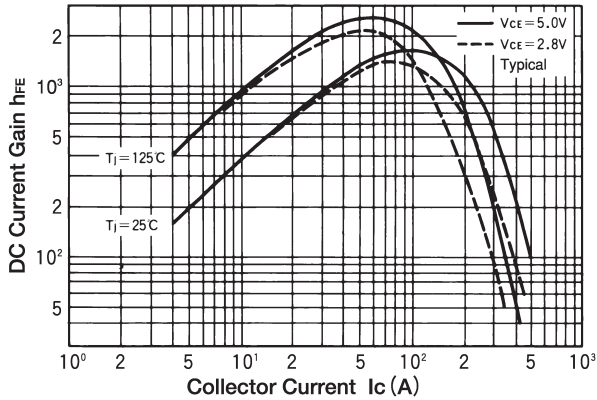

Saturation Characteristics

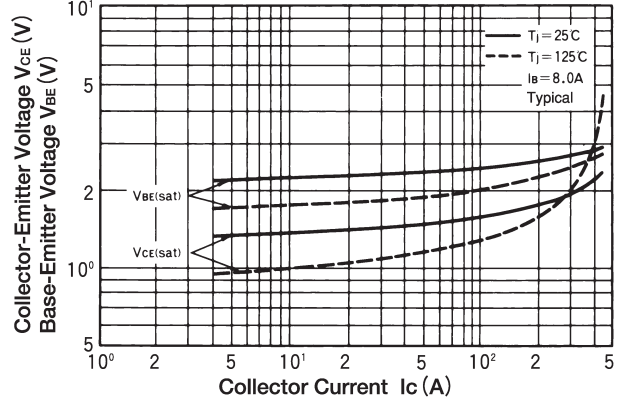

Forward Bias Safe Operating Area

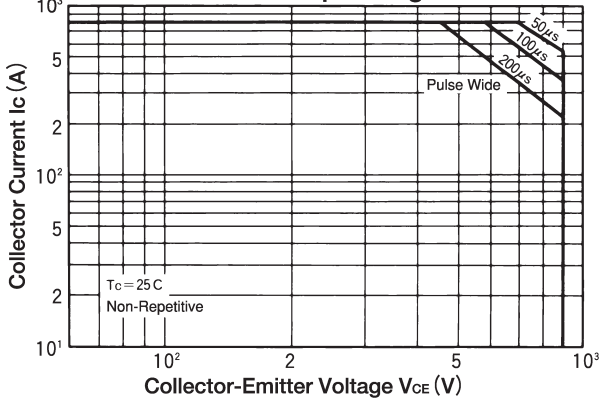

Reverse Bias Safe Operating Area

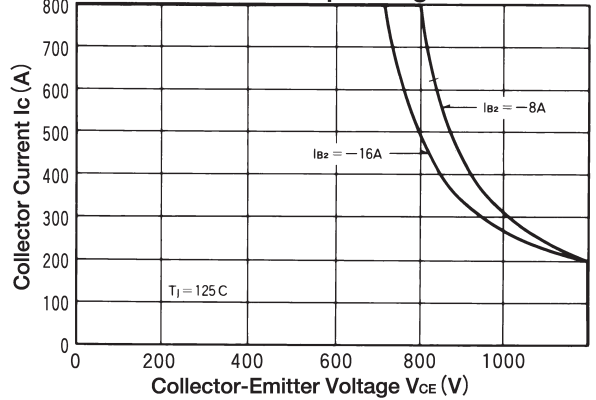

Collector Current Derating Factor

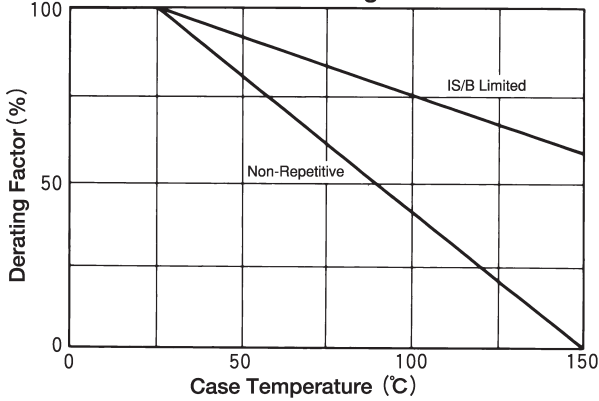

Forward Voltage of Free Wheeling Diode

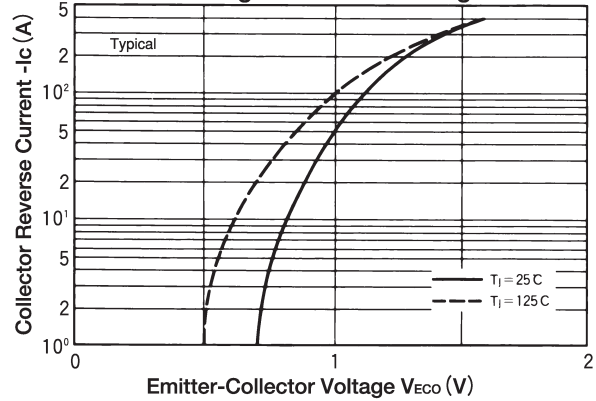

Collector Current Vs Switching Time

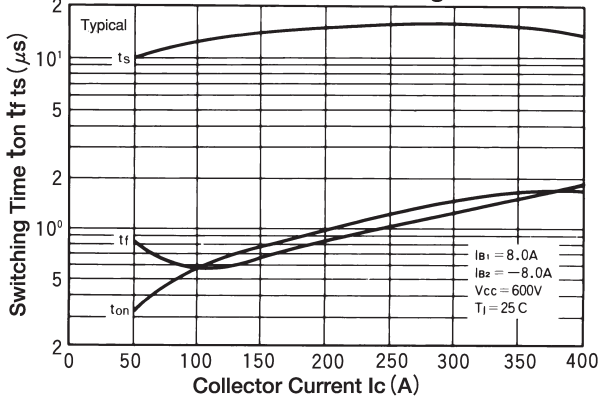

Maximum Transient Thermal Impedance Characteristics

