

Variable Capacitance Diode

**Description**

The 1T413 is a variable capacitance diode designed for the digital cellular phone VCO using a super-small-miniature flat package (SSVC).

**Features**

- Super-small-miniature flat package
- Low series resistance: 0.40 Ω Max. (f=470 MHz)
- Large capacitance ratio: 2.90 Typ. (C1/C4)
- Small leakage current: 10 nA Max. (VR=15 V)

**Applications**

Digital cellular phone VCO

**Structure**

Silicon epitaxial planar type diode

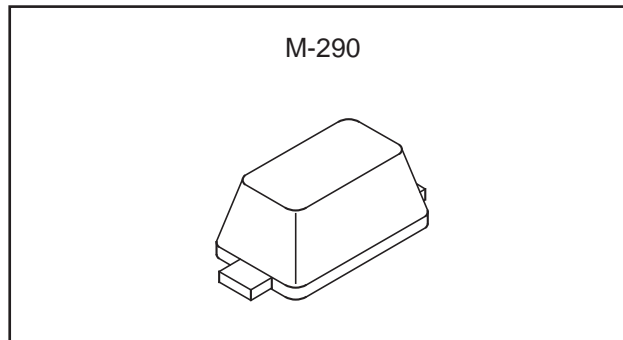

**Absolute Maximum Ratings (Ta=25 °C)**

- Reverse voltage VR 15 V
- Operating temperature Topr -20 to +75 °C
- Storage temperature Tstg -65 to +150 °C

**Electrical Characteristics**

(Ta=25 °C)

Item	Symbol	Conditions	Min.	Typ.	Max.	Unit
Reverse current	IR	VR=15 V			10.0	nA
Diode capacitance	C1	VR=1 V, f=1 MHz	15.0		17.5	pF
	C4	VR=4 V, f=1 MHz	5.1		6.1	pF
Capacitance ratio	C1/C4		2.5	2.9		
Series resistance	rs	VR=1 V, f=470 MHz			0.40	Ω

Sony reserves the right to change products and specifications without prior notice. This information does not convey any license by any implication or otherwise under any patents or other right. Application circuits shown, if any, are typical examples illustrating the operation of the devices. Sony cannot assume responsibility for any problems arising out of the use of these circuits.

Example of Representative Characteristics

Diode capacitance vs. Reverse voltage

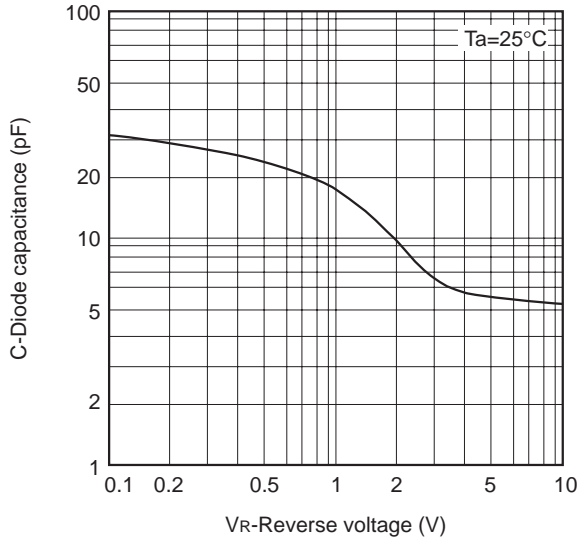

Reverse current vs. Ambient temperature

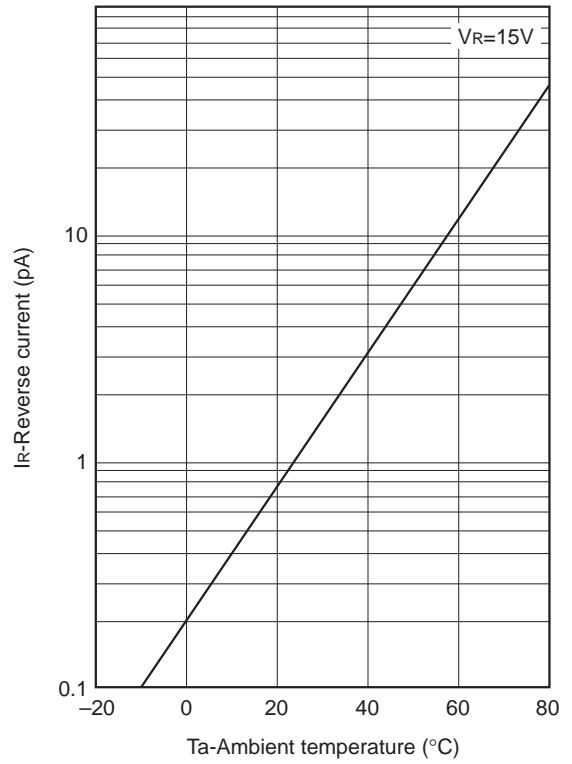

Forward voltage vs. Ambient temperature

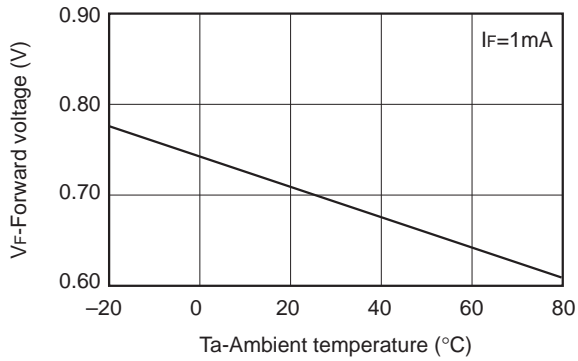

Reverse voltage vs. Ambient temperature

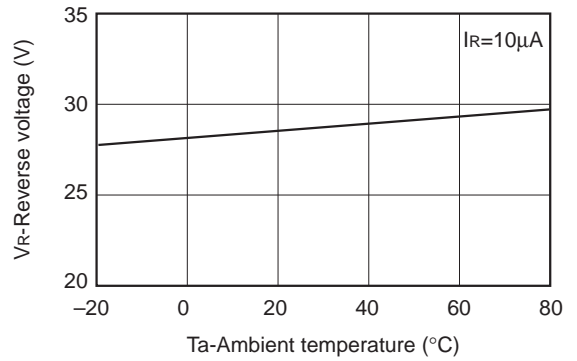

Diode capacitance vs. Ambient temperature

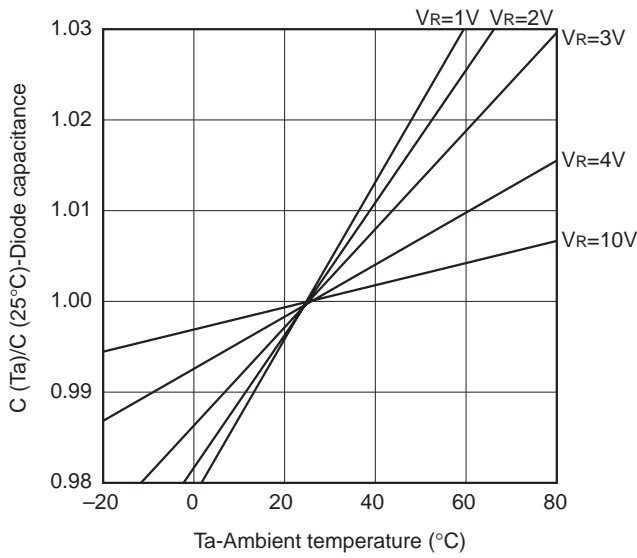

Temperature coefficient of diode capacitance

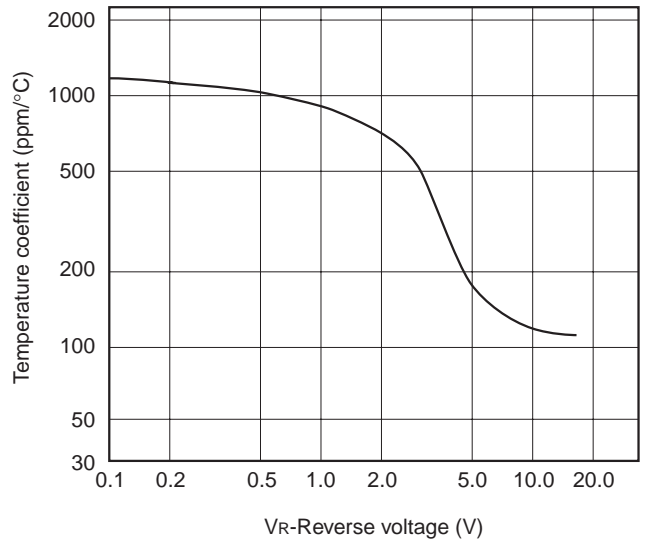

Reverse current vs. Reverse voltage

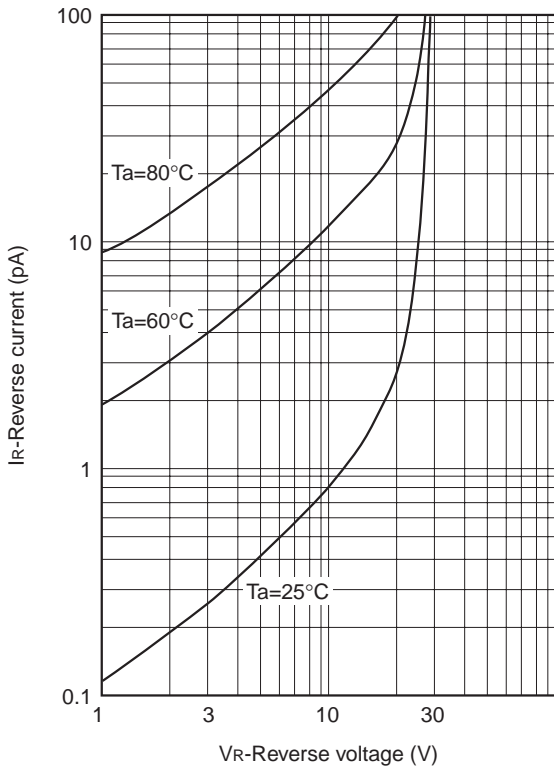

Series resistance vs. Reverse voltage

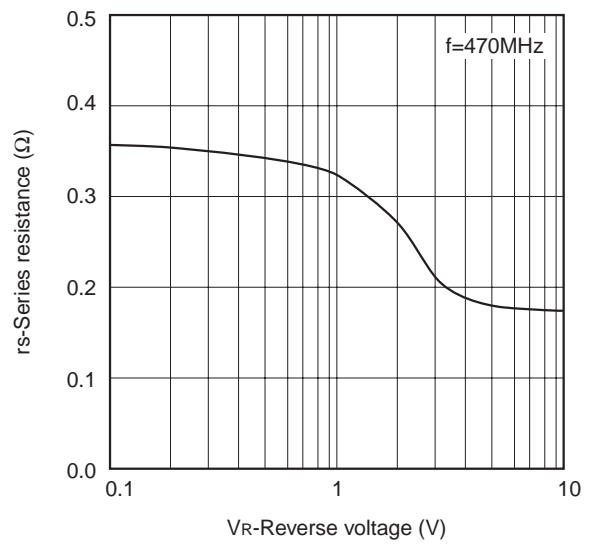

Package Outline Unit : mm

M-290

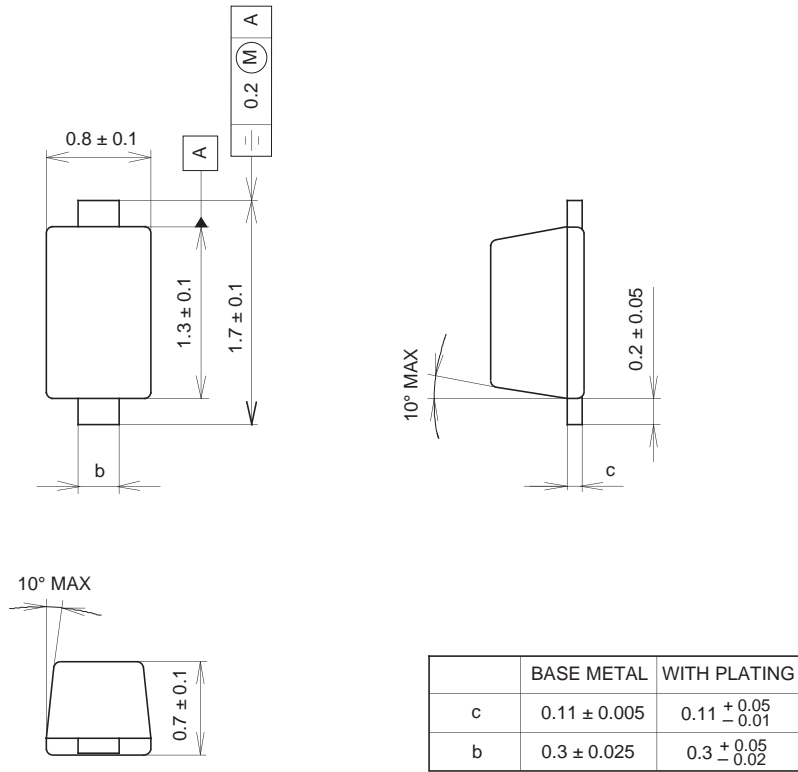

SONY CODE	M-290
EIAJ CODE	_____
JEDEC CODE	_____

PACKAGE MATERIAL	EPOXY RESIN
LEAD TREATMENT	SOLDER PLATING
LEAD MATERIAL	COPPER
PACKAGE WEIGHT	0.002g

Mark

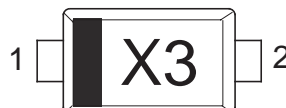

- 1 ♂Cathode
- 2 ♂Anode