

Laser Driver

Description

The CXB1558Q-Y is a high-speed monolithic Laser Driver/Current Switch with ECL input level. Open collector outputs are provided at the output pins (Q, \bar{Q}) and have the capability of driving modulation current of 60mA_{pp} at a max. data rate of 2.0Gbps (NRZ). DRIVADJ and SDRIV inputs control the modulation current amplitude, and BIASADJ, SBIAS inputs control the bias current. Modulation and bias current can be controlled by either voltage or current through these pins. This device includes D-FF for duty cycle correction and Laser Shutdown function.

32 pin QFP (Ceramic)

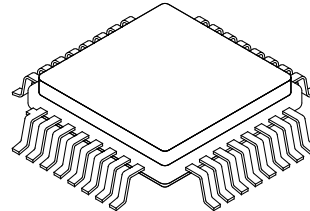

Features

- Maximum data rate (NRZ): 2.0Gbps (Typ.)
- Differential Data input: ECL
- D-FF for Duty Cycle Correction
- Laser Shutdown Input: TTL

Applications

- SONET/SDH: 155,622Mb/s, 1.2Gb/s
- Fiber channel: 133,266,532Mb/s, 1.062Gb/s
- FDDI: 125Mb/s ESCON: 200Mb/s HDTV: 1.5Gb/s

Absolute Maximum Ratings

• Supply voltage	$V_{CC} - V_{EE}$	-0.3 to +7.0	V
• Input voltage	V_{IN}	V_{EE} to +0.5	V
• Differential input voltage	$ V_{IN} - \bar{V}_{IN} $	0 to 2.5	V
• Differential clock voltage	$ V_{CLK} - \bar{V}_{CLK} $	0 to 2.5	V
• Output current (Continuous)	I_Q, I_{BIAS}	0 to 80	mA
Input current (Continuous)	I_{DRVADJ}	0 to 8	mA
	$I_{BIASADJ}$	0 to 8	mA
• Storage temperature	T_{stg}	-65 to +150	°C

Recommended Operating Conditions

• DC power supply voltage	$V_{CC} - V_{EE}$	4.75 to 5.46	V
• Operating case temperature	T_c	0 to +85	°C

Structure

Bipolar silicon monolithic IC

Sony reserves the right to change products and specifications without prior notice. This information does not convey any license by any implication or otherwise under any patents or other right. Application circuits shown, if any, are typical examples illustrating the operation of the devices. Sony cannot assume responsibility for any problems arising out of the use of these circuits.

Pin Description

Pin No.	Symbol	Typical voltage (V)		Equivalent circuit	Description	
		DC	AC			
1	SDRIV	0mA to 8mA*1 0mA to 6mA*2	—		Modulation generator current monitor.	
32	DRIVADJ	V _{EE} to V _{EE} +2.5V	—		Modulation generator current adjustment.	
2, 10	V _{EE} 2	-5.2V	—		Negative power supply pin.	
3	\bar{Q}	—	0mA to 60mA*1		Modulation generator current output.	
4			0mA to 40mA*2			
5	Q	—	0mA to 60mA*1			
6			0mA to 40mA*2			
7	BIASB	0mA to 30mA	—			Bias generator current output.
8	BIASA					
9	SBIAS	0mA to 8mA	—		Bias generator current monitor.	
11	BIASADJ	V _{EE} to V _{EE} +2.5V	—		Bias generator current adjustment.	
20	$\overline{\text{CLK}}$	—	-1.84V to -0.81V		Clock signal input.	
21	CLK					
19	V _{EE}	-5.2V	—			

*1 V_{EE} = -5.46V to -4.94V

*2 V_{EE} = -4.94V to -4.75V

Pin No.	Symbol	Typical voltage (V)		Equivalent circuit	Description
		DC	AC		
26	V _{BB}	-1.3V	—		Reference voltage (-1.3V) Use for the reference voltage in the case of single-phase input. Max. drive current ±200μA
25	V _{EE1}	-5.2V	—		Negative power supply pin.
27	\bar{D}	—	-1.84V to -0.81V		Data signal input.
28	D	—	-1.84V to -0.81V		
29	V _{CC1}	0V	—		Positive power supply pin.
30	\bar{P}	—	0mA to 2.7mA		Input signal monitor output.
31	P	—			

Electrical Characteristics**• DC Electrical Characteristics**(V_{CC1} = V_{CC2} = GND, V_{EE1} = V_{EE2} = -5.46 to -4.75V, T_c = 0 to +85°C)

Item	Symbol	Condition	Min.	Typ.	Max.	Unit
Power supply current	I _{EE}	I _Q = 0mA, I _{BIAS} = 0mA	-110	-78	—	mA
		I _Q = 60mA, I _{BIAS} = 60mA	-260	-213	—	
Max. Modulation current	I _Q	V _{EE} = -5.46 to -4.94V	60	—	—	mA
		V _{EE} = -4.94 to -4.75V	40	—	—	
Modulation output voltage range	V _Q	T _c = 25°C	-2.5	—	2.0	V
Max. Bias current	I _{BIAS}	I _{BIASA} + I _{BIASB}	60	—	—	mA
Bias output voltage range	V _{BIAS}		-2.7	—	0.0	V
Modulation current monitor output voltage range	V _{SQ}	at voltage control application	-2.7	—	0.0	
Bias current monitor output voltage range	V _{SBIAS}	at voltage control application	-2.7	—	0.0	
Input signal monitor current	I _P		1	1.7	2.7	mA
Input signal monitor output voltage range	V _P	T _c = 25°C	-2.5	—	2.0	V
ECL Input High voltage	V _{EDH}		-1.17	—	-0.81	
ECL Input Low voltage	V _{EDL}		-1.84	—	-1.48	
ECL Input High current	I _{EDH}		—	—	20	μA
TTL Input High voltage	V _{TDH}		V _{EE} + 2.0	—	V _{CC}	V
TTL Input Low voltage	V _{TDL}		V _{EE} - 0.5	—	V _{EE} + 0.8	
TTL Input High current	I _{TDH}		—	—	10	μA
TTL Input Low current	I _{TDL}		-320	—	—	
Reference bias voltage	V _{BB}		-1.38	-1.32	-1.26	V

Ratio of current setup

Item	Symbol	Condition	Min.	Typ.	Max.
Modulation current vs. Modulation monitor current	S1	at voltage control application	9.0	11.4	12.0
Modulation current vs. Modulation control current	S2	at current control application	6.5	8.6	10.5
Bias current vs. Bias monitor current	S3	at voltage control application	11.0	12.0	13.0
Bias current vs. Bias control current	S4	at current control application	7.4	9.8	12.0

Voltage Control Application

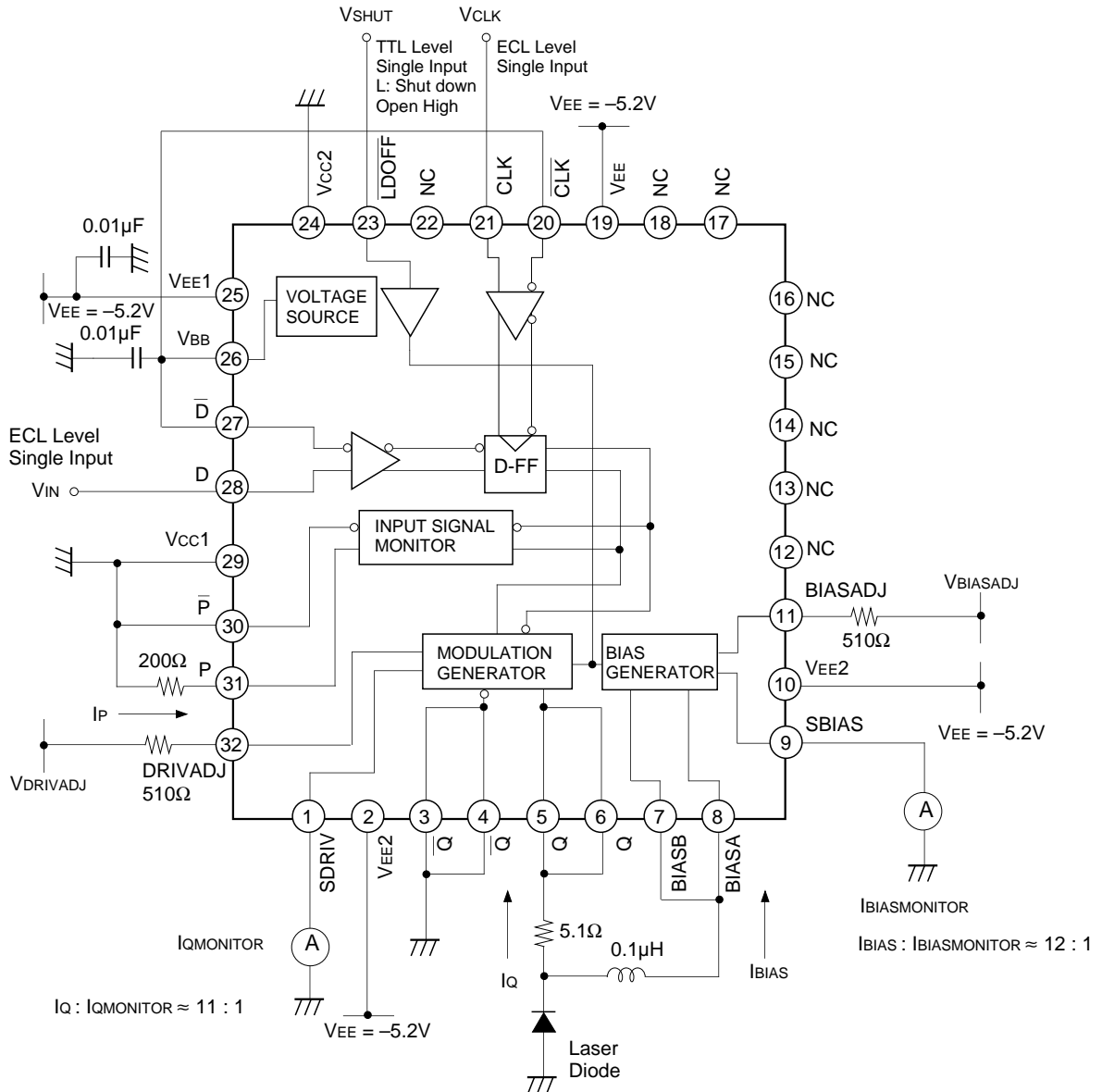

Cautions for Handling

1. The outputs (Q, \bar{Q} , BIASA, BIASB, SDRIV, SBIAS, P and \bar{P}) on this IC are the open collector type. Therefore, when these pins are not being used, connect them to Vcc.
2. When the inputs (DRIVEADJ and BIASADJ) are not being used, connect them to VEE.
3. Do not apply voltage over VEE + 2.5V to DRIVADJ pin and BIASADJ pin.
4. In voltage control Application, do not apply voltage over the output voltage range to SDRIV pin and SBIAS pin. (see DC Characteristics of Laser Part and Voltage Control Application Circuit.)
5. Maximum drive current of VBB pin is $\pm 200\mu A$.
6. Maximum input differential voltage is 2.5V. (| D - \bar{D} | , | CLK - \bar{CLK} |)
7. As the electronic breakdown level is weak, take care to handle.

Example of Representative Characteristics

Modulation current vs. Modulation control current

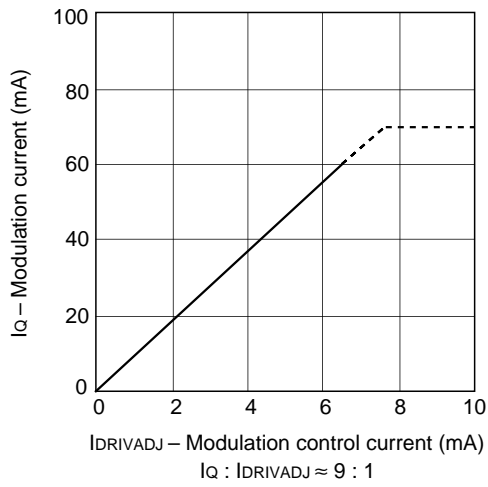

Bias current vs. Bias control current

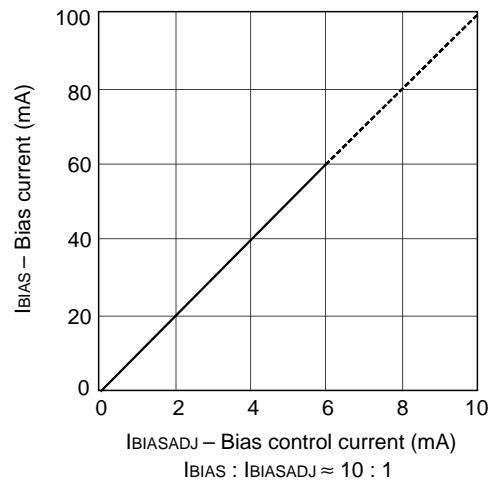

Modulation current vs. Modulation control voltage

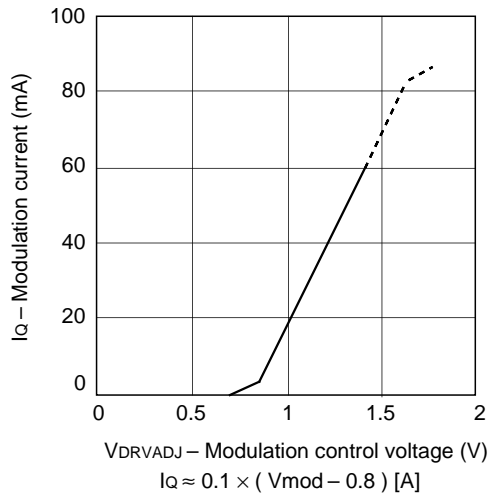

Bias current vs. Bias control voltage

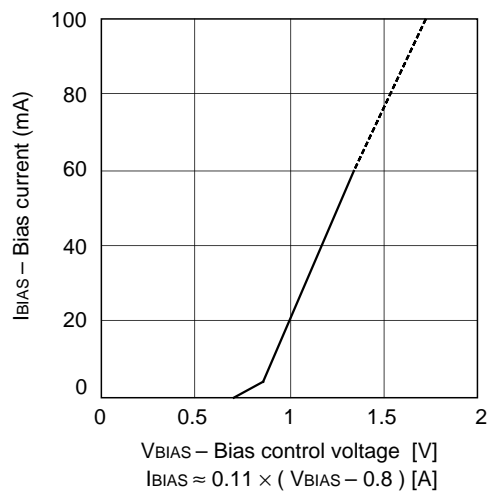

Package Outline

Unit: mm

32PIN QFP (CERAMIC)

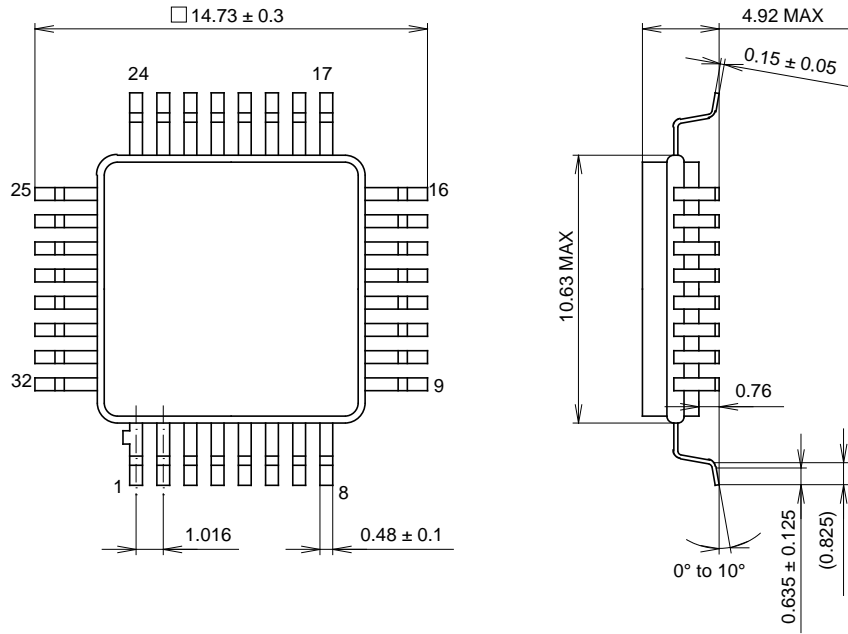

PACKAGE STRUCTURE

SONY CODE	QFP-32C-L01
EIAJ CODE	XQFP023-G-0000-A
JEDEC CODE	_____

PACKAGE MATERIAL	CERAMIC
LEAD TREATMENT	TIN PLATING
LEAD MATERIAL	42 ALLOY
PACKAGE WEIGHT	0.3g