

High-Power Density 2W Laser Diode

Description

The SLD324ZT is a gain-guided, high-power density laser diode with a built-in TE cooler. A new flat, square package with a low thermal resistance and an in-line pin configuration is employed. Fine tuning of the wavelength is possible by controlling the laser chip temperature.

Features

- High power
Recommended optical power output: $P_o = 2.0W$
- Low operating current: $I_{op} = 2.5A$ ($P_o = 2.0W$)
- Newly developed flat package with built-in photodiode, TE cooler and thermistor

Applications

- Solid state laser excitation
- Medical use
- Material processes
- Measurement

Structure

GaAlAs quantum well structure laser diode

Absolute Maximum Ratings ($T_{th} = 25^{\circ}C$)

- | | | | |
|--------------------------------------|-----------|------------|-------------|
| • Optical power output | P_o | 2.2 | W |
| • Reverse voltage | V_R LD | 2 | V |
| | PD | 15 | V |
| • Operating temperature (T_{th}) | T_{opr} | -10 to +30 | $^{\circ}C$ |
| • Storage temperature | T_{stg} | -40 to +85 | $^{\circ}C$ |
| • Operating current of TE cooler | I_T | 4.0 | A |

Equivalent Circuit

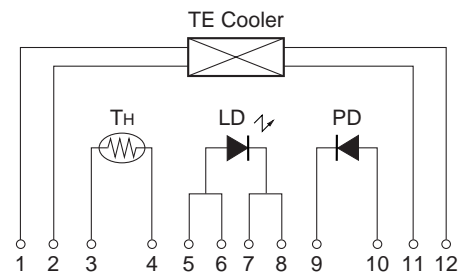

Pin Configuration (Top View)

No.	Function	No.	Function
1	TE Cooler (negative)	7	LD (cathode)
2	TE Cooler (negative)	8	LD (cathode)
3	Thermistor	9	PD (cathode)
4	Thermistor	10	PD (anode)
5	LD (anode)	11	TE Cooler (positive)
6	LD (anode)	12	TE Cooler (positive)

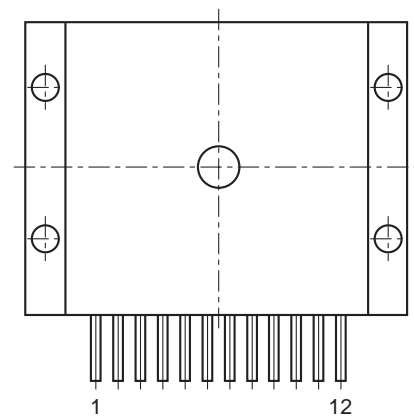

Sony reserves the right to change products and specifications without prior notice. This information does not convey any license by any implication or otherwise under any patents or other right. Application circuits shown, if any, are typical examples illustrating the operation of the devices. Sony cannot assume responsibility for any problems arising out of the use of these circuits.

Electrical and Optical Characteristics

(Tth: Thermistor temperature, Tth = 25°C)

Item	Symbol	Conditions	Min.	Typ.	Max.	Unit	
Threshold current	Ith			0.6	1.0	A	
Operating current	Iop	P _O = 2.0W		2.5	3.5	A	
Operating voltage	Vop	P _O = 2.0W		2.2	3.0	V	
Wavelength*1	λp	P _O = 2.0W	790		840	nm	
Monitor current	I _{mon}	P _O = 2.0W V _R = 10V	0.15	0.8	3.0	mA	
Radiation angle (F. W. H. M.*)	Perpendicular	θ _⊥	P _O = 2.0W	20	30	40	degree
	Parallel			θ _{//}	4	9	17
Positional accuracy	Position	ΔX, ΔY	P _O = 2.0W			±100	μm
	Angle	Δφ _⊥				±3	degree
Differential efficiency	η _D	P _O = 2.0W	0.65	1.0		W/A	
Thermistor resistance	R _{th}	T _{th} = 25°C		10		kΩ	

* F. W. H. M. : Full Width at Half Maximum

***1 Wavelength Selection Classification**

Type	Wavelength (nm)
SLD324ZT-1	795 ± 5
SLD324ZT-2	810 ± 10
SLD324ZT-3	830 ± 10

Type	Wavelength (nm)
SLD324ZT-21	798 ± 3
SLD324ZT-24	807 ± 3
SLD324ZT-25	810 ± 3

Handling Precautions

Eye protection against laser beams

The optical output of laser diodes ranges from several mW to 3W. However the optical power density of the laser beam at the diode chip reaches 1MW/cm². Unlike gas lasers, since laser diode beams are divergent, uncollimated laser diode beams are fairly safe at a laser diode. For observing laser beams, ALWAYS use safety goggles that block infrared rays. Usage of IR scopes, IR cameras and fluorescent plates is also recommended for monitoring laser beams safely.

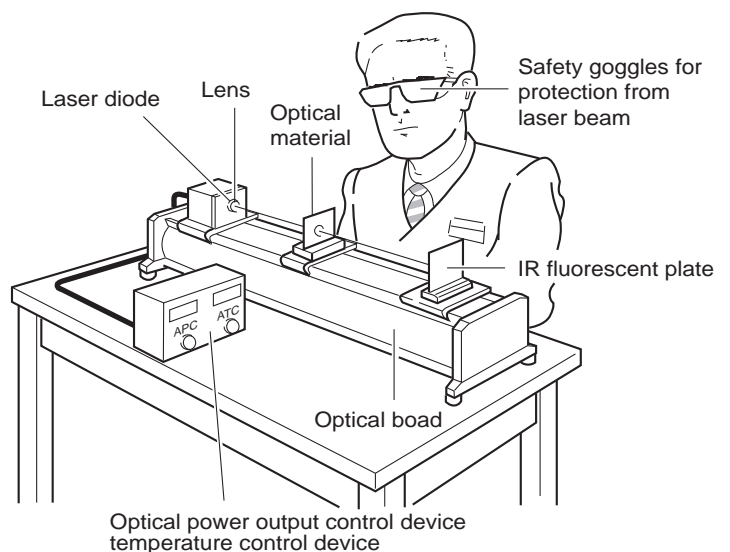

Example of Representative Characteristics

Optical power output vs. Forward current characteristics

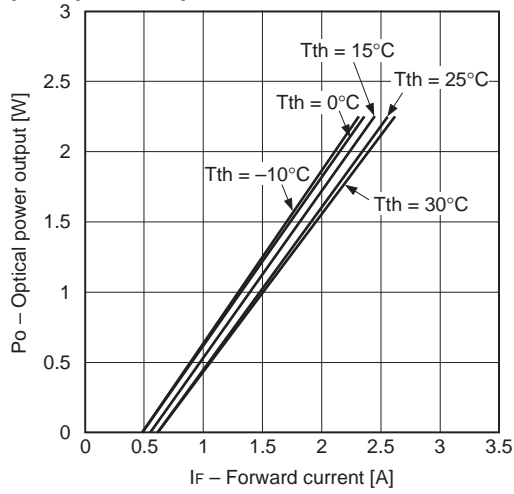

Optical power output vs. Monitor current characteristics

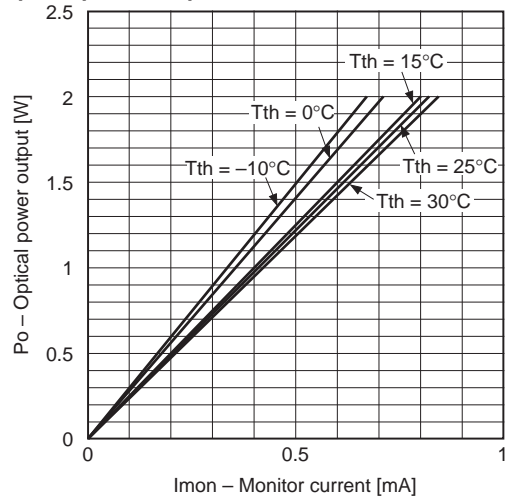

Threshold current vs. Temperature characteristics

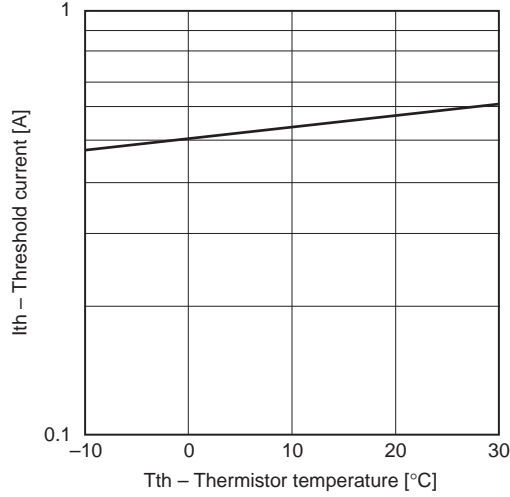

Dependence of wavelength

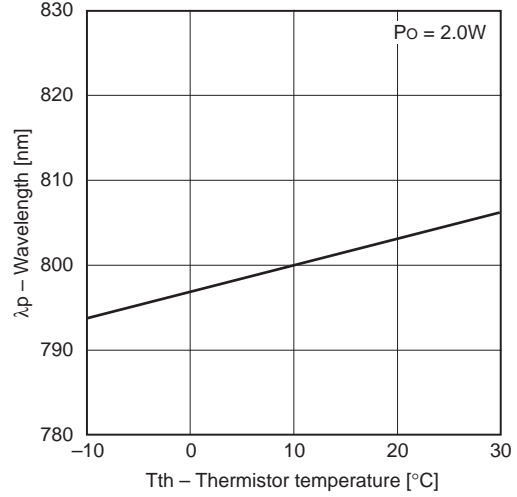

Power dependence of far field pattern (Perpendicular to junction)

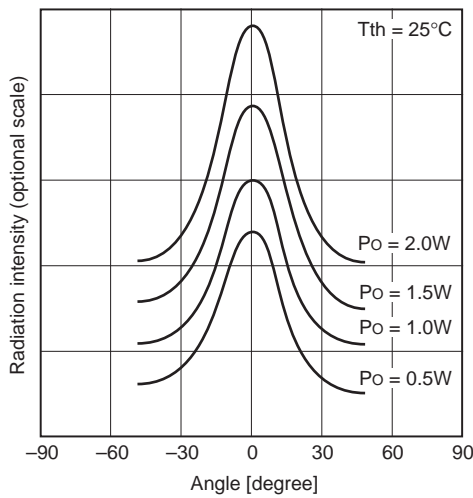

Power dependence of far field pattern (Parallel to junction)

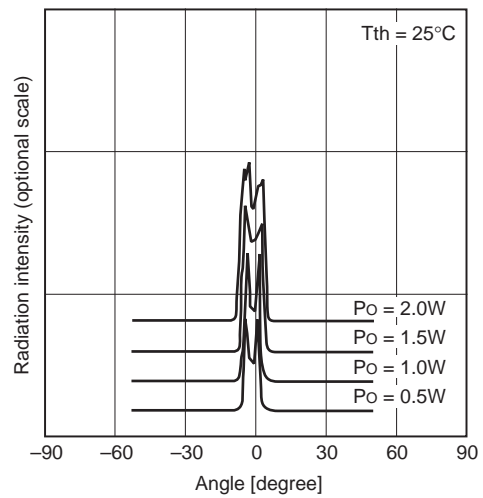

Differential efficiency vs. Temperature characteristics

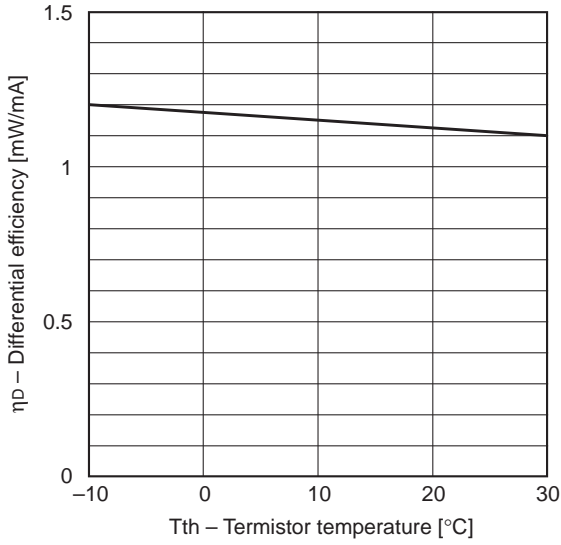

Termistor characteristics

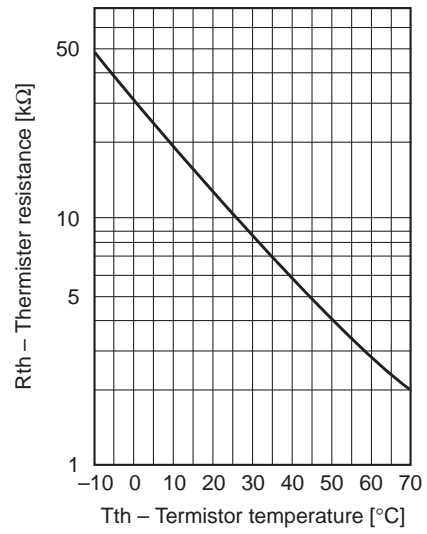

TE cooler characteristics

TE cooler characteristics 1

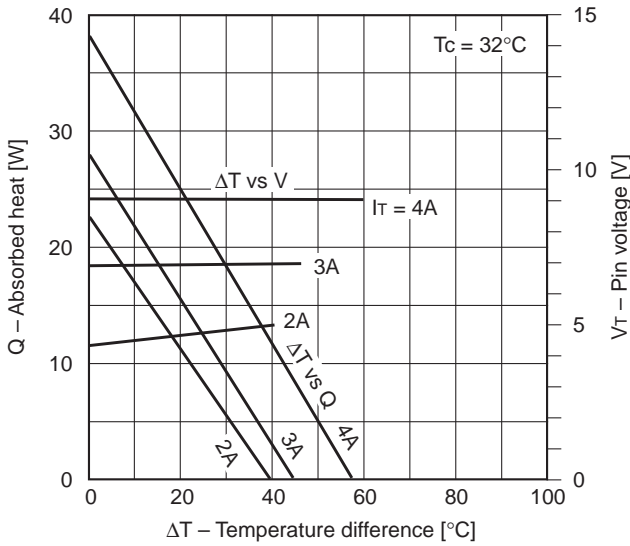

TE cooler characteristics 2

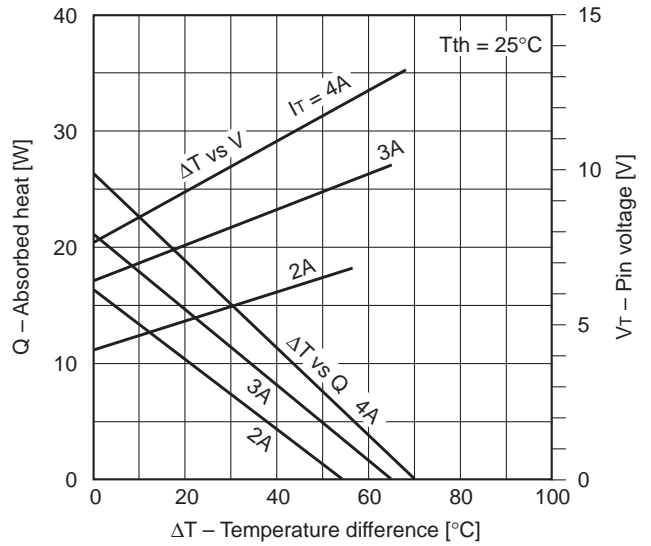

ΔT : $T_c - T_{th}$
 T_{th} : Thermistor temperature
 T_c : Case temperature

Power dependence of spectrum

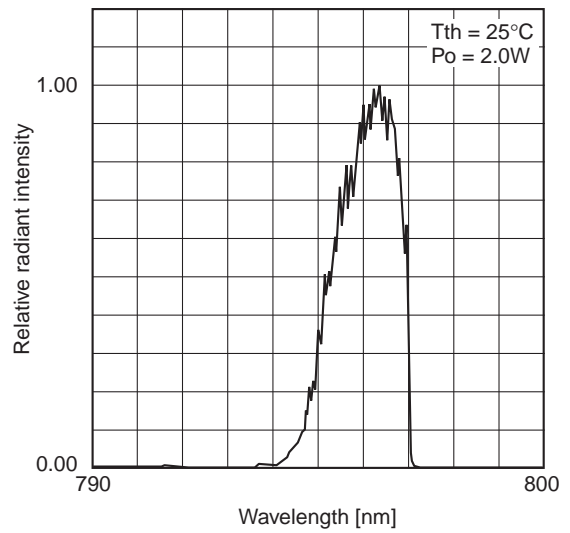
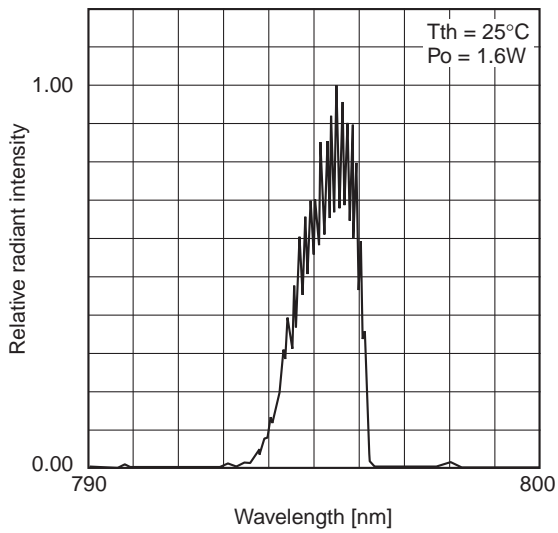
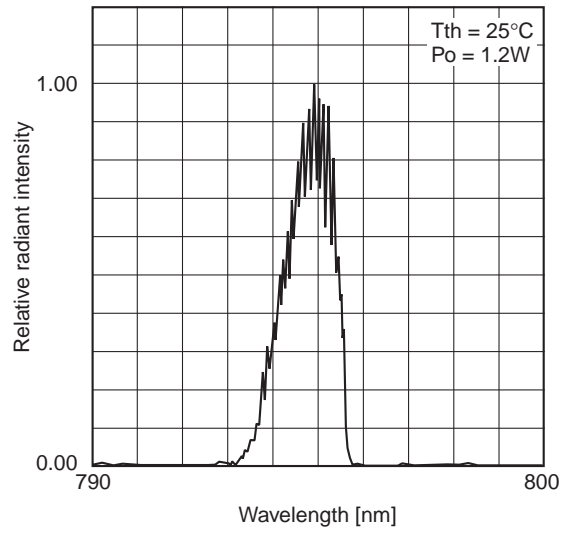
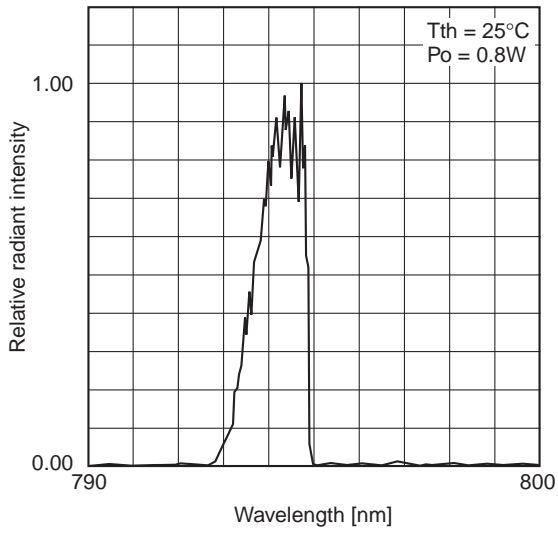

Temperature dependence of spectrum ($P_o = 2W$)

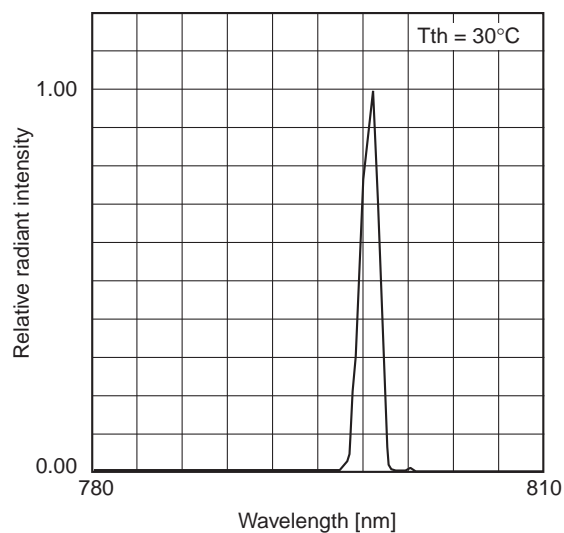
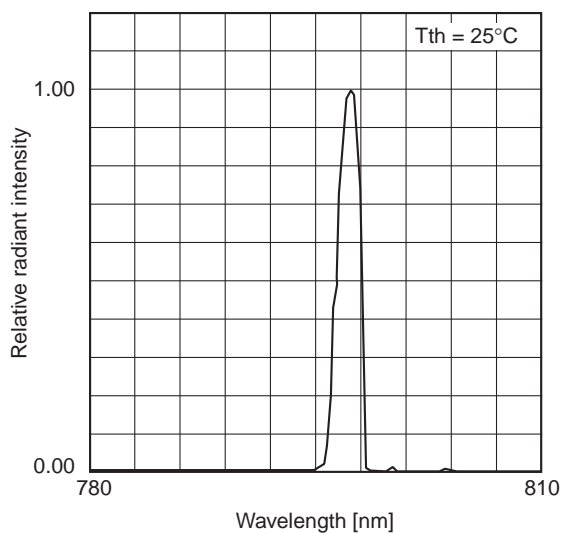
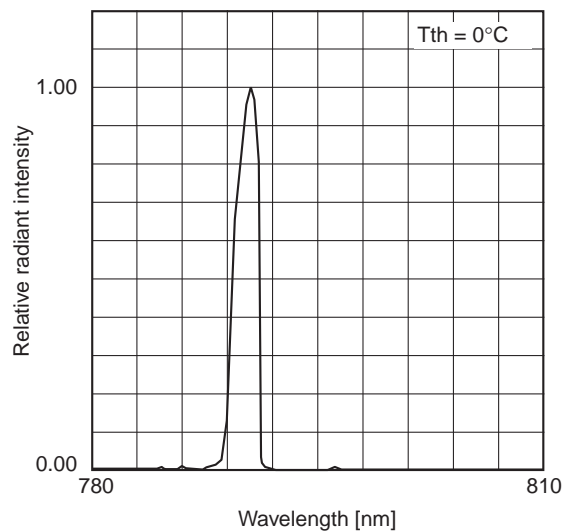
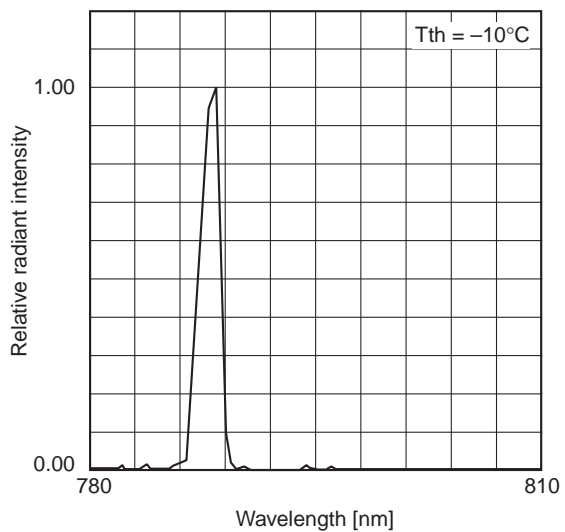

Package Outline

Unit: mm

M-272

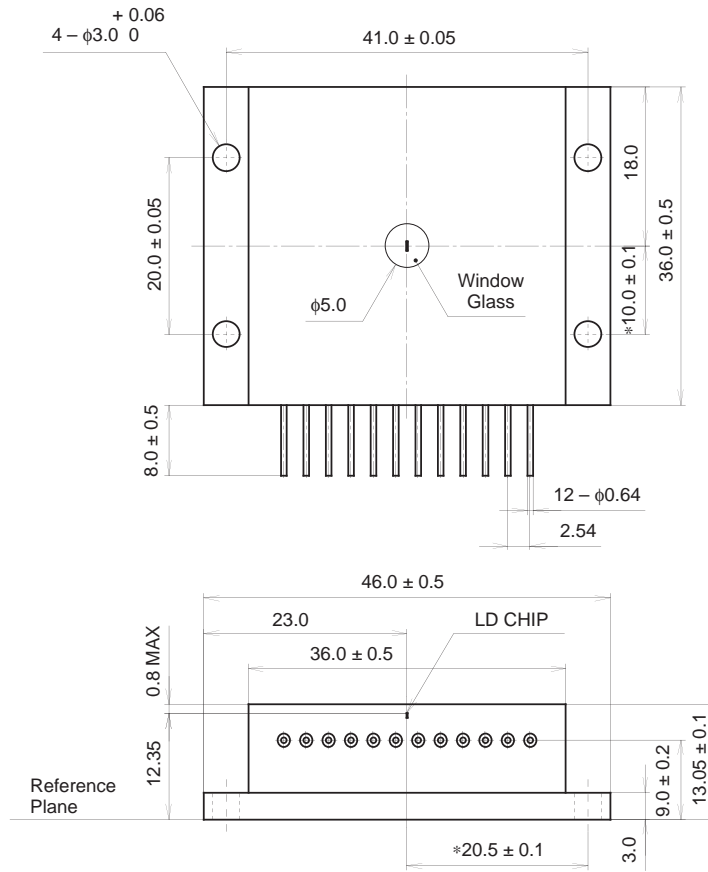

*Distance between pilot hole and emitting area.

SONY CODE	M-272
EIAJ CODE	_____
JEDEC CODE	_____

PACKAGE WEIGHT	118 g
----------------	-------