

8 mm VCR AFM Signal Processor

Description

The CXA1488R is an IC designed for recording and playback FM audio signal processing for an 8 mm VCR. In combination with a CXA1536Q device it offers an effective implementation of an AFM audio stereo system.

Features

- Built-in filter (1.5 MHz bandpass filter)
- Requires no adjustment of FM modulator central frequency.
- Low current consumption (standby 24 mA, recording 27 mA, playback 1 (band-pass filter on) 31 mA, playback 2 (band-pass filter off) 27 mA)
- PAL/NTSC selectable
- Stereo compatible
- Very few external part

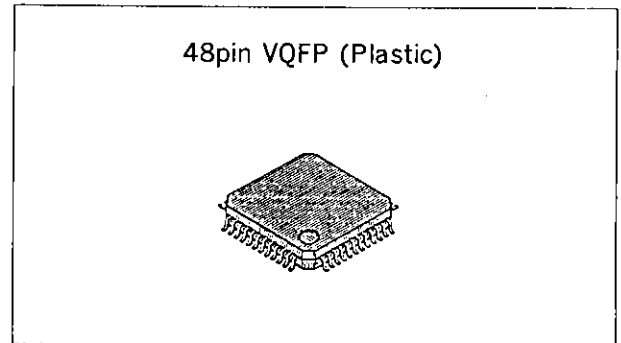

Application
8 mm VCR

Structure

Bipolar silicon monolithic IC

Block Diagram

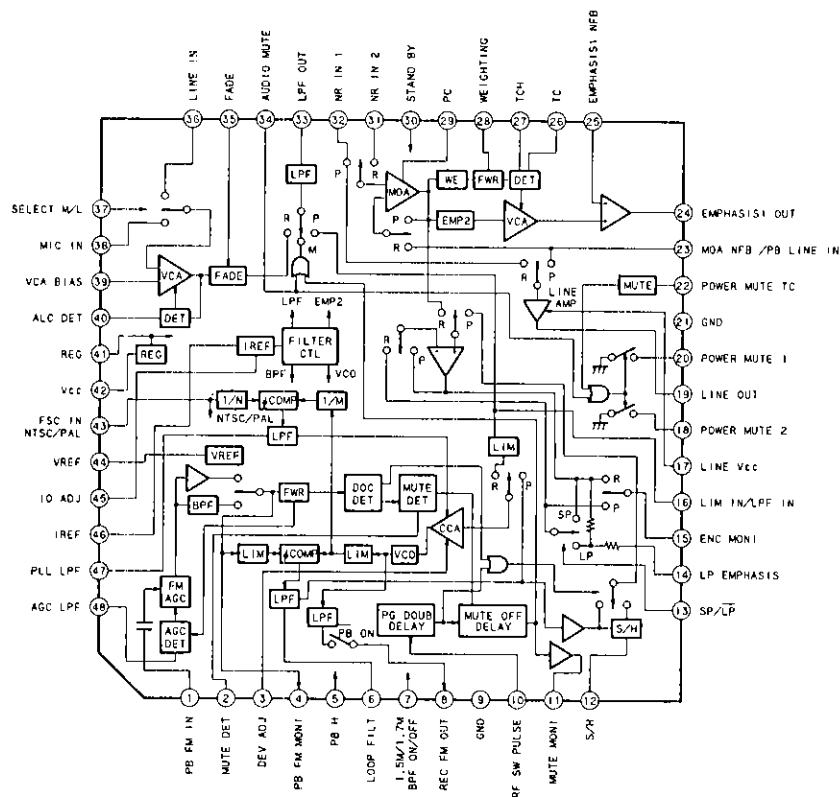

Absolute Maximum Ratings (Ta = 25°C)

• Supply voltage	V_{CC}	7	V
• Operating temperature	T_{opr}	-20 to +75	°C
• Storage temperature	T_{stg}	-40 to +150	°C
• Allowable power dissipation	P_D	600	mW

Operating Conditions

• Supply voltage	4.75	V
• Supply voltage range	4.5 to 5.5	V

Pin Description

0 dBs = 2.191 Vp-p

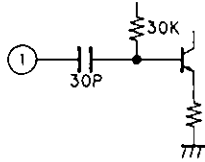
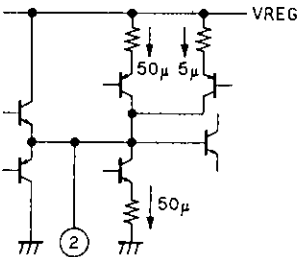
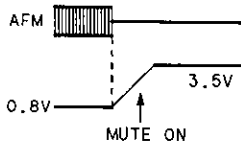
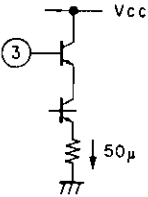
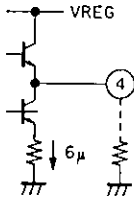
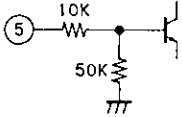
No.	Symbol	DC voltage	AC voltage	Equivalent circuit	Remarks
1	PB FM IN	—	—		Reference input level is 30 mVp-p with AFM
2	MUTE DET	—	—		
3	DEV ADJ	—	—		Input voltage 1.85 V to V_{CC}
4	PB FM MONI	2.1 V	250 mVp-p		Load resistor connected in monitor mode
5	PB H	0 V	—		High: playback Low/open: record

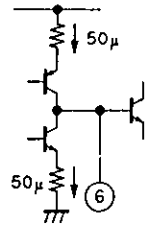
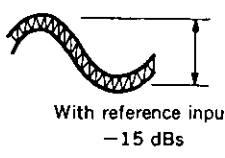
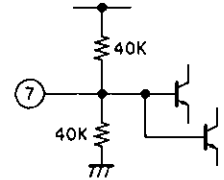
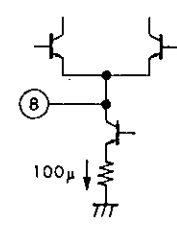
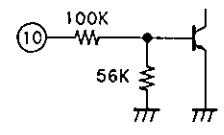
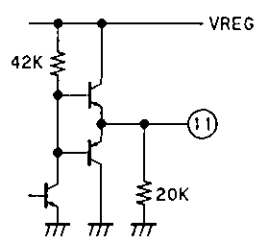
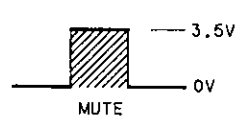
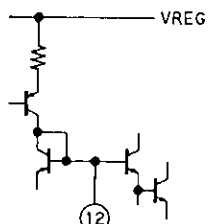
No.	Symbol	DC voltage	AC voltage	Equivalent circuit	Remarks
6	LOOP FILT	2.1 V	-15 dBs		
7	BPF ON/OFF 1.5M/1.7M	—	—		High: 1.5 MHz band-pass filter on Open: 1.5 MHz band-pass filter off Low: 1.7 MHz band-pass filter off
8	REC FM OUT	2.1 V	340 mVp-p		In playback mode Standard DC: 1.4 V Standard AC: 0 V
9	GND	—	—	—	
10	RF SW P. IN	—	—		
11	MUTE MONI	—	—		
12	S/H	2.1 V	-15 dBs		With reference input

No.	Symbol	DC voltage	AC voltage	Equivalent circuit	Remarks
13	SP/LP	—	—		High: SP Low/open: LP
14	LP EMPHSIS	2.1 V	-15 dBs		With reference input
15	ENC MONI	2.1 V	-15 dBs		With reference input (with no playback signal: 0 V)
16	LIM IN	2.1 V	-15 dBs		With reference input
17	LINE V _{CC}	—	—	—	
18	POWER MUTE2	—	—		
19	LINE OUT	2.1 V	-7 dBs		With reference input
20	POWER MUTE1	—	—		

No.	Symbol	DC voltage	AC voltage	Equivalent circuit	Remarks
21	GND	—	—		
22	POWER MUTE TC	—	—		
23	MOA NFB	2.1 V	-15 dBs		With reference input
24	EMP1 OUT	2.1 V	-15 dBs		With reference input
25	EMP1 NFB	2.1 V	-27.6 dBs		With reference input
26	TC	2 V approx.	—		With reference input
27	TCH	2.6 V approx.	—		With reference input

No.	Symbol	DC voltage	AC voltage	Equivalent circuit	Remarks
28	WEIGHTING	2.1 V	—		
29	PC	2.8 V	—		
30	STAND BY	2.1 V	—		High: standby off Low/open: standby on
31	NR IN2	2.1 V	-15 dBs		With reference input
32	NR IN1	2.1 V	-15 dBs		With reference input
33	LPF OUT	2.1 V	-15 dBs		With reference input
34	AUDIO MUTE	2.1 V	—		High/open: mute on Low: mute off

No.	Symbol	DC voltage	AC voltage	Equivalent circuit	Remarks
35	FADE	—	—		Input voltage 1.85 V to V _{CC}
36	LINE IN	2.1 V	—		Reference input level -20.5 dBs
37	SELECT	—	—		High: MIC Low/open: LINE
38	MIC IN	2.1 V	—		Reference input level -38.0 dBs
39	ALC BIAS	2.1 V	—		
40	ALC DET	—	—		I _R : MIC: 24.8 μA LINE: 4.6 μA

No.	Symbol	DC voltage	AC voltage	Equivalent circuit	Remarks
41	REG	4.2 V	—		
42	V_{CC}	—	—	—	
43	FSC IN NTSC/PAL	—	—		FSC = 100 to 200 mVp-p High - NTSC Low/open: PAL
44	VREF	2.1 V	—		
45	I_0 ADJ	—	—		Input voltage 1.85 V to V_{CC}
46	I REF	2.2 V	—		When 3.3 V is applied to Pin 45

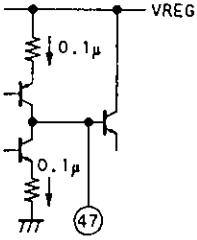
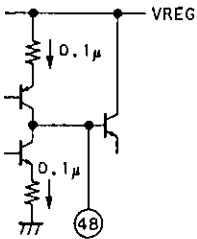
No.	Symbol	DC voltage	AC voltage	Equivalent circuit	Remarks
47	PLL LPF	2.1 V	—		
48	AGC LPF	2.1 V	—		

Electrical Characteristics (Ta = 25°C, V_{CC} = 4.75 V)0 dBs = 2.191 V_{p-p}

No.	Item	Symbol	Conditions		Min.	Typ.	Max.	Unit
			Input	Test point				
1	Current consumption standby	I _{CCST}		I _{CC}	19.2	24.0	28.8	mA
2	Current consumption recording	I _{CC R}		↓	21.6	27.0	32.4	mA
3	Current consumption playback 1 (band-pass filter on)	I _{CC P1}		↓	24.8	31.0	37.2	mA
4	Current consumption playback 2 (band-pass filter off)	I _{CC P2}		↓	21.6	27.0	32.4	mA
5	REG output	V _{REG}		TP9	4.05	4.20	4.35	V
6	Reference voltage	V _{REF}		TP10	2.02	2.10	2.18	V

REC MODE <ALC, LPF>

7	Input switch crosstalk 1	CT1	10kHz, -5dBs	TP8		-78	-70	dB
8	Input switch crosstalk 2	CT2	10kHz, -5dBs	↓		-78	-70	dB
9	ALC output level 1	V _{oa 1}	400Hz, -38dBs (MIC input)	↓	-16.0	-15.0	-14.0	dBs
10	ALC output level 2	V _{oa 2}	400Hz, -21dBs (LINE input)	↓	-16.0	-15.0	-14.0	dBs
11	ALC output level 3	V _{oa 3}	400Hz, -25dBs (MIC input)	↓	-10.5	-9.0	-7.5	dBs
12	ALC effect	ALC	400Hz, -28dBs → -2dBs	↓		0	3.0	dB
13	FADE attenuation	ATT	400Hz, -38dBs IN4=4.5V	↓		-85	-80	dB

<NR>

14	Output level 1	V _{oe 1}	400Hz, -15dBs	TP4	-16.0	-15.0	-14.0	dBs
15	Output level 2	V _{oe 2}	400Hz, -35dBs	↓	-26.5	-25.0	-23.5	dBs
16	Output level 3	V _{oe 3}	400Hz, -55dBs	↓	-37.0	-35.0	-33.0	dBs
17	Output level 4	V _{oe 4}	7kHz, -15dBs	↓	-12.4	-10.9	-9.4	dBs
18	Output level 5	V _{oe 5}	7kHz, -35dBs	↓	-22.4	-20.9	-19.4	dBs
19	Output level 6	V _{oe 6}	7kHz, -55dBs	↓	-32.9	-30.9	-28.9	dBs
20	Distortion factor	THDE	400Hz, -15dBs	↓		0.2	0.5	%
21	Output noise level	V _{noe}	Rg=1kΩ (IHF-A filter)	↓		-57	-51	dBs

<ALC - LINE>

No.	Item	Symbol	Conditions		Min.	Typ.	Max.	Unit
			Input	Test point				
22	Line output level	V_{o1}	400Hz, -38dBs	TP6	-8.5	-7.0	-5.5	dBs
23	Line output noise level 1	V_{no1}	Rg=1k Ω (IHF-A filter) LINE input	↓		-79	-74	dBs
24	Line output noise level 2	V_{no2}	Rg=1k Ω (IHF-A filter) MIC input	↓		-76	-71	dBs
25	Line output distortion factor	THDL	400Hz, -38dBs	↓		0.1	0.4	%
26	Earphone output level	V_{oep}	400Hz, -38dBs	TP7	-27.5	-26.0	-24.5	dBs

<LINE AMP>

27	Line maximum output	V_{1max}	400Hz, THD=1%	TP6	0.5	2.5		dBs
----	---------------------	------------	---------------	-----	-----	-----	--	-----

<FM MOD>

28	Oscillator frequency 1 NTSC 1.5 MHz	Fr1	3.579545MHz	TP2	1.4995	1.5000	1.5005	MHz
29	Oscillator frequency 2 NTSC 1.7 MHz	Fr2	3.579545MHz	↓	1.6995	1.7000	1.7005	MHz
30	Oscillator frequency 3 PAL 1.5 MHz	Fr3	4.433619MHz	↓	1.4995	1.5000	1.5005	MHz
31	Oscillator frequency 4 PAL 1.7 MHz	Fr4	4.433619MHz	↓	1.6995	1.7000	1.7005	MHz
32	Output level 1.5/1.7	Vor	3.579545MHz	↓	300	340	380	mVp-p
33	Secondary distortion	HD2nd	3.579545MHz	↓		-46	-40	dB
34	Tertiary distortion	HD3rd	3.579545MHz	↓		-31	-25	dB

PB MODE <demodulator>

35	Output level	Vdem	fc=1.5M, fs=1k, 60kHz FM, 30mVp-p	TP8	-16.0	-15.0	-14.0	dBs
36	Output distortion factor	THDd	fc=1.5M, fs=1k, 60kHz FM, 30mVp-p	TP6		0.26	0.4	%
37	Output noise level	Vnod	fc=1.5M, 30mVp-p, (IHF-A filter)	TP8		-71	-64	dBs
38	AM rejection	AMR	fc=1.5M, fs=1k, 30mVp-p, 30% AM	↓		-71	-64	dBs

<LPF output frequency characteristics>

No.	Item	Symbol	Conditions		Min.	Typ.	Max.	Unit
			Input	Test point				
39	30kHz LPF1	LPF1	fc=1.5M, fs=10k, 60kHz FM, 30mVp-p	TP8	-16.0	-15.0	-14.0	dBs
40	30kHz LPF2	LPF2	fc=1.5M, fs=30k, 60kHz FM, 30mVp-p	↓	-17.5	-16.5	-15.5	dBs
41	LP emphasis on	LPE	fc=1.5M, fs=7k, 60kHz FM, 30mVp-p	↓	-19.5	-17.5	-15.5	dBs

<FM AGC>

42	AGC output level 1	AGC1	fc=1.5M, 30mVp-p	TP1	200	250	300	mVp-p
43	AGC output level 2	AGC2	fc=1.5M, 7mVp-p	↓	140	170	200	mVp-p
44	AGC output level 3	AGC3	fc=1.5M, 12mVp-p	↓	200	250	300	mVp-p
45	AGC output level 4	AGC4	fc=1.5M, 100mVp-p	↓	200	250	300	mVp-p

<BPF>

46	1.5MHz±100kHz	BPF2	fc=1.5MHz±100kHz, 7mVp-p	TP1	-6	-5	-3	dB
47	1.5MHz±200kHz	BPF3	fc=1.5MHz±200kHz, 7mVp-p	↓		-15.5	-14.5	dB
48	1.2MHz TRAP	TRAP1	fc=1.2MHz, 7mVp-p	↓		-38	-31	dB
49	1.8MHz TRAP	TRAP2	fc=1.8MHz, 7mVp-p	↓		-35	-30	dB
50	BPF OFF GAIN	VGBPF	fc=1.8MHz, 7mVp-p (=0dB)	↓	26.0	28.0	30.0	dB

<DO, MUTE>

51	DO detector on level	DOon	fc=1.5MHz, level of AGC shoulder (=0dB)	IN1	-10	-7.5	-5	dB
52	DO hysteresis	DOoff	fc=1.5MHz, with DO on level as 0 dB	↓	1	3.5	6	dB
53	Mute on time	T _{mon}	※ 1	↓	140	220	300	μsec
54	Mute hold time	T _{mh}	※ 1	↓	130	150	170	msec
55	PG doubler pulse width 1	T _{pgw} 1	fc=1.5MHz, 30mVp-p	TP4	5.0	7.0	9.0	μsec
56	PG doubler pulse width 2	T _{pgw} 2	fc=1.5MHz, 30mVp-p	↓	5.5	7.5	9.5	μsec
57	PG doubler pulse width 3	T _{pgw} 3	fc=1.5MHz, 30mVp-p	↓	6.7	8.7	10.7	μsec
58	PG doubler delay time 1	T _{pgt} 1	fc=1.5MHz, 30mVp-p	↓	1.0	2.0	3.0	μsec
59	PG doubler delay time 2	T _{pgt} 2	fc=1.5MHz, 30mVp-p	↓	1.0	2.0	3.0	μsec
60	PG doubler delay time 3	T _{pgt} 3	fc=1.5MHz, 30mVp-p	↓	1.0	2.0	3.0	μsec

<ADJ>

No.	Item	Symbol	Conditions		Min.	Typ.	Max.	Unit
			Input	Test point				
61	I0 adj variable width	I0	IN6 variable	IN6	1.85	3.3	V _{CC}	V
62	DEV adj variable width	DEV	IN2 variable, 400Hz, -15dBs	IN2	1.85	3.3	V _{CC}	V
63	Fade control variable width	FADE	IN4 variable, 400Hz, -38dBs	IN4	1.85	3.3	V _{CC}	V

<POWER MUTE>

64	Power mute on resistor 1	R _{pm 1}		TP5		20	30	Ω
65	Power mute on resistor 2	R _{pm 2}		TP7		20	30	Ω

※ 1

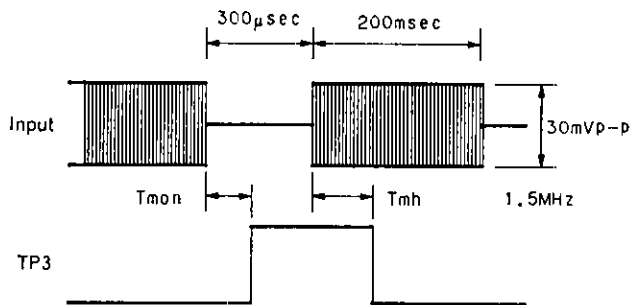

Electrical Measurements

Switch Mode Table

MODE	INPUT POSITION		
	HIGH	OPEN	LOW
	4.0V~V _{CC}		0V~0.5V
PB/REC	PB	REC	
SELECT	MIC	LINE	
AUDIO MUTE	MUTE ON		MUTE OFF
FADE	ADJUST		
SP/LP	SP	LP	
NTSC/PAL	NTSC	PAL	
1.5M BPF ON/1.5M BPF OFF/1.7M	1.5M BPF ON	1.5M BPF OFF	1.7M
STAND BY	OFF	ON	

Test Program Table

No.	Switch No.															Input point	Remarks
	1	2	3	4	5	6	7	8	9	10	11	12	13	14	15		
1	b	a	b	a	b	OFF	b	a	b	b	b	b	a	b	a		
2	↓	↓	↓	↓	↓	↓	a	↓	↓	↓	↓	↓	↓	↓	↓		
3	a	↓	↓	↓	↓	↓	↓	↓	↓	↓	↓	↓	↓	↓	↓		
4	↓	b	↓	↓	↓	↓	↓	↓	↓	↓	↓	↓	↓	↓	↓		
5	b	a	↓	↓	↓	↓	↓	↓	↓	↓	↓	↓	↓	↓	↓		
6	↓	↓	↓	↓	↓	↓	↓	↓	↓	↓	↓	↓	↓	↓	↓		
7	↓	↓	↓	↓	↓	↓	c	↓	↓	↓	a	↓	↓	↓	↓		
8	↓	↓	↓	↓	↓	↓	↓	↓	↓	↓	b	b	a	↓	↓		
9	↓	↓	↓	↓	↓	↓	↓	↓	↓	↓	↓	a	↓	↓	↓		
10	↓	↓	↓	↓	↓	↓	↓	↓	↓	↓	a	b	b	↓	↓		
11	↓	↓	↓	↓	↓	↓	↓	↓	↓	↓	↓	a	a	↓	↓		
12	↓	↓	↓	↓	↓	↓	↓	↓	↓	↓	↓	↓	↓	↓	↓		
13	↓	↓	↓	↓	↓	↓	↓	↓	a	↓	↓	↓	↓	↓	↓		
14	↓	↓	↓	↓	↓	↓	↓	↓	b	↓	↓	↓	↓	↓	↓		
15	↓	↓	↓	↓	↓	↓	↓	↓	↓	↓	↓	↓	↓	↓	↓		
16	↓	↓	↓	↓	↓	↓	↓	↓	↓	↓	↓	↓	↓	↓	↓		
17	↓	↓	↓	↓	↓	↓	↓	↓	↓	↓	↓	↓	↓	↓	↓		
18	↓	↓	↓	↓	↓	↓	↓	↓	↓	↓	↓	↓	↓	↓	↓		
19	↓	↓	↓	↓	↓	↓	a	c	↓	↓	↓	↓	↓	↓	↓		
20	↓	↓	↓	↓	↓	↓	↓	↓	↓	↓	↓	↓	↓	↓	↓		
21	↓	↓	↓	↓	↓	↓	↓	b	↓	b	↓	↓	↓	↓	↓		
22	↓	↓	↓	↓	↓	↓	↓	a	↓	↓	↓	↓	↓	↓	↓		
23	↓	↓	↓	↓	↓	↓	↓	↓	↓	↓	↓	b	↓	↓	↓		
24	↓	↓	↓	↓	↓	↓	↓	↓	↓	↓	↓	a	b	↓	↓		
25	↓	↓	↓	↓	↓	↓	↓	↓	↓	↓	↓	↓	a	↓	↓		
26	↓	↓	↓	↓	↓	ON	↓	↓	↓	↓	↓	↓	↓	↓	↓		
27	↓	↓	↓	↓	↓	OFF	↓	c	↓	a	↓	↓	↓	↓	↓		
28	↓	↓	↓	↓	a	↓	↓	a	↓	b	↓	↓	↓	↓	↓		

IN7 = 3.579545MHz

No.	Switch No.															Input point	Remarks
	1	2	3	4	5	6	7	8	9	10	11	12	13	14	15		
29	↓	b	↓	a	OFF	↓	a	b	b	b	b	a	a	a	a		IN7 = 3.579545MHz
30	↓	a	↓	↓	↓	↓	↓	↓	↓	↓	↓	↓	↓	↓	b		IN7 = 4.433619MHz
31	↓	c	↓	↓	↓	↓	↓	↓	↓	↓	↓	↓	↓	↓	↓		IN7 = 4.433619MHz
32	↓	a/c	↓	↓	↓	↓	↓	↓	↓	↓	↓	↓	↓	a	↓		IN7 = 3.579545MHz
33	↓	a	↓	↓	↓	↓	↓	↓	↓	↓	↓	↓	↓	↓	↓		IN7 = 3.579545MHz
34	↓	↓	↓	↓	↓	↓	↓	↓	↓	↓	↓	↓	↓	↓	↓		IN7 = 3.579545MHz
35	a	↓	↓	↓	b	↓	c	↓	↓	↓	↓	↓	↓	↓	↓	IN1	
36	↓	↓	↓	↓	↓	↓	a	↓	↓	↓	↓	↓	↓	↓	↓	↓	
37	↓	↓	↓	↓	↓	↓	c	↓	↓	↓	↓	↓	↓	↓	↓		
38	↓	↓	↓	↓	↓	↓	↓	↓	↓	↓	↓	↓	↓	↓	↓	IN1	Apply 30% AM, taking 30 mVp-p as 0 dB
39	↓	↓	↓	↓	↓	↓	↓	↓	↓	↓	↓	↓	↓	↓	↓	↓	
40	↓	↓	↓	↓	↓	↓	↓	↓	↓	↓	↓	↓	↓	↓	↓	↓	
41	↓	↓	↓	b	↓	↓	↓	↓	↓	↓	↓	↓	↓	↓	↓	↓	
42	↓	↓	↓	a	↓	↓	↓	↓	↓	↓	↓	↓	↓	↓	↓	↓	
43	↓	↓	↓	↓	↓	↓	↓	↓	↓	↓	↓	↓	↓	↓	↓	↓	
44	↓	↓	↓	↓	↓	↓	↓	↓	↓	↓	↓	↓	↓	↓	↓	↓	
45	↓	↓	↓	↓	↓	↓	↓	↓	↓	↓	↓	↓	↓	↓	↓	↓	
46	↓	↓	↓	↓	↓	↓	↓	↓	↓	↓	↓	↓	↓	↓	↓	↓	Attenuation from 1.5 M Hz
47	↓	↓	↓	↓	↓	↓	↓	↓	↓	↓	↓	↓	↓	↓	↓	↓	Attenuation from 1.5 M Hz
48	↓	↓	↓	↓	↓	↓	↓	↓	↓	↓	↓	↓	↓	↓	↓	↓	Attenuation from 1.5 M Hz
49	↓	↓	↓	↓	↓	↓	↓	↓	↓	↓	↓	↓	↓	↓	↓	↓	Attenuation from 1.5 M Hz
50	↓	b	↓	↓	↓	↓	↓	↓	↓	↓	↓	↓	↓	↓	↓	↓	
51	↓	a	a	↓	↓	↓	↓	↓	↓	↓	↓	↓	↓	↓	↓	↓	IN1 level for TP4 to switch from high to low.
52	↓	↓	↓	↓	↓	↓	↓	↓	↓	↓	↓	↓	↓	↓	↓	↓	IN1 level for TP4 to switch from low to high.
53	↓	↓	↓	↓	b	↓	↓	↓	↓	↓	↓	↓	↓	↓	↓	↓	
54	↓	↓	↓	↓	↓	↓	↓	↓	↓	↓	↓	↓	↓	↓	↓	↓	
55	↓	↓	↓	↓	↓	↓	↓	↓	↓	↓	↓	↓	↓	↓	↓	↓	
56	↓	b	↓	↓	↓	↓	↓	↓	↓	↓	↓	↓	↓	↓	↓	↓	

No.	Switch No.															Input point	Remarks
	1	2	3	4	5	6	7	8	9	10	11	12	13	14	15		
57	a	c	a	a	b	OFF	a	c	b	b	b	b	a	a	a	IN1	
58	↓	↓	↓	↓	↓	↓	↓	↓	↓	↓	↓	↓	↓	↓	↓	↓	
59	↓	↓	↓	↓	↓	↓	↓	↓	↓	↓	↓	↓	↓	↓	↓	↓	
60	↓	↓	↓	↓	↓	↓	↓	↓	↓	↓	↓	↓	↓	↓	↓	↓	
61	b	a	↓	↓	↓	↓	↓	↓	↓	↓	↓	↓	↓	↓	↓		Voltage on IN6 for the voltage on TP11 to become 2.20 V.
62	↓	↓	↓	↓	↓	↓	↓	↓	↓	a	↓	↓	↓	↓	↓	IN5	Voltage on IN2 for the deviation on TP2 to become 1.5 MHz ±60.
63	↓	↓	↓	↓	↓	↓	↓	↓	↓	a	b	↓	↓	↓	↓	↓	Voltage on IN4 for the output level on TP8 to go from -15 dBs to -80 dBs.
64	↓	↓	↓	↓	↓	↓	↓	↓	a	b	a	↓	↓	↓	↓	↓	Computation from TP5 and TP6.
65	↓	↓	↓	↓	↓	↓	↓	↓	↓	↓	↓	↓	↓	↓	↓	↓	Computation from TP6 and TP7.

Electrical Test Circuit

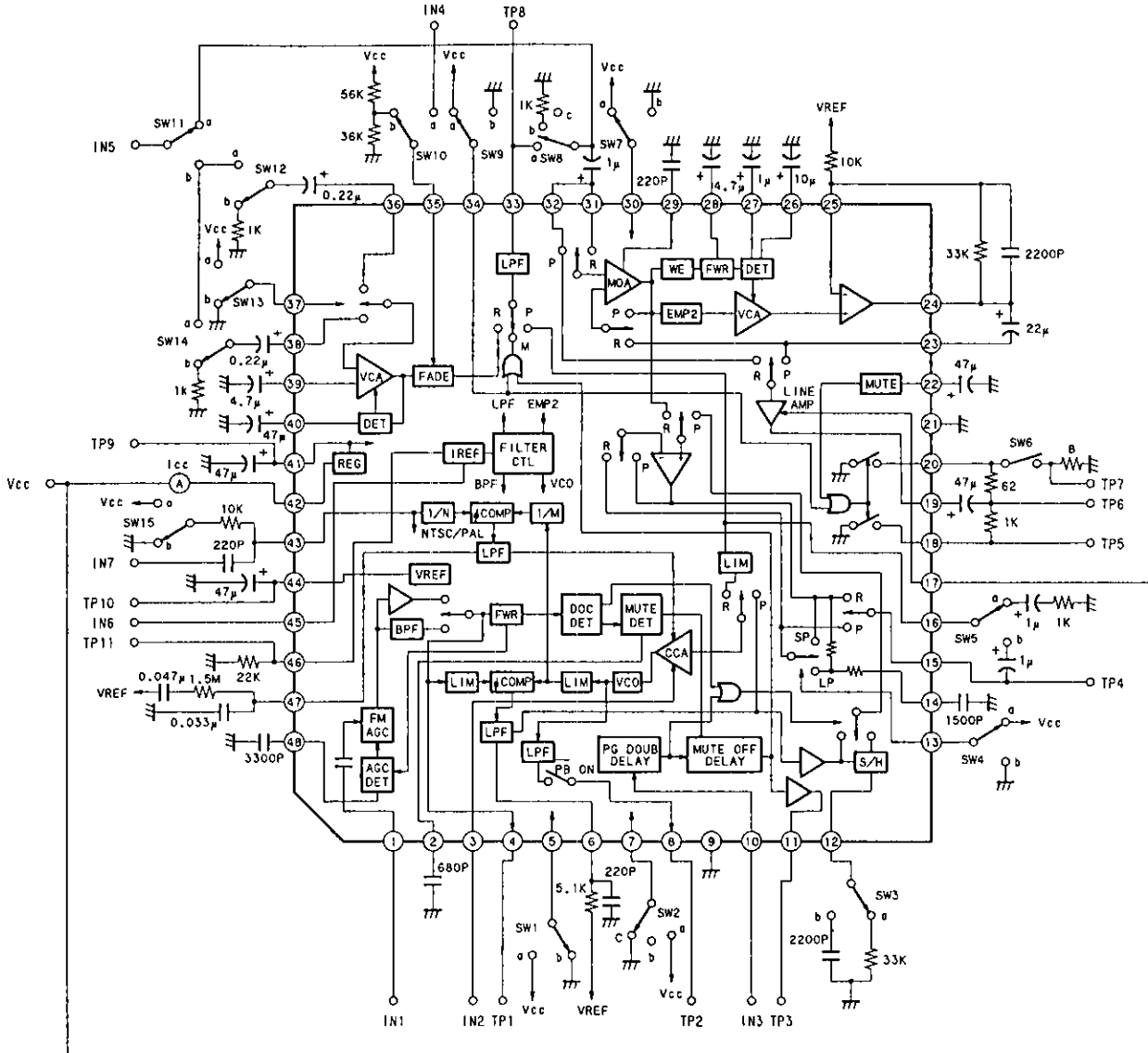

Note: If monitoring Pin 4, connect a resistor of approximately 10 kΩ between this pin and ground.

