

6ch. Read/Write Amplifier for Thin Film Head of Hard Disk Drive

Description

The CXA3090N is a Read/Write Amplifier for the thin film head of hard disk drive and designed to handle up to 6 channel heads.

Features

- Operate on single +5 V power supply
- Low power consumption
 - Read : 85 mW
 - Write : 115 mW + I_w × 5
- Designed for two terminal thin-film or MIG heads
- Read amplifier emitter follower output featuring 325 times gain (typ).
- Differential input capacitance for Read : 6pF (typ)
- Input noise : 0.47 nV / √Hz (typ)
- Write current range : 5 to 15 mA
- Differential Head voltage swing : 6.8 Vp-p (typ)
- Differential P-ECL write data input
- Built-in write unsafe detection circuit.
- Built-in Servo write function (3/6 ch).
- Built-in IC protection circuit for short of head and GND.
- Read data outputs are high impedance in write mode.
- Unselected head voltage is GND potential.
- Built-in supply voltage monitor circuit prohibits incorrect write during power on or abnormal voltage.
- Self switching damping resistance (R_D = 350 Ω).

Function

Read, Write and Write unsafe detection for HDD, power supply ON/OFF detection.

Structure

Bipolar silicon monolithic IC

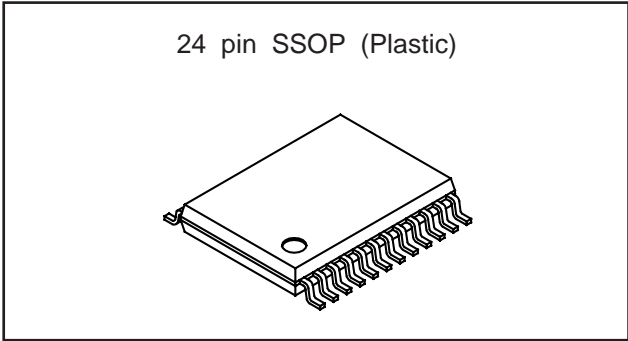

Absolute Maximum Ratings (T_a=25 °C)

- Supply voltage V_{CC} 6 V
- Write current I_w 20 mAo-p
- Operating temperature T_{opr} -20 to +75 °C
- Storage temperature T_{stg} -55 to +150 °C
- Allowable power dissipation

P _D	800	mW
----------------	-----	----
- WUS/SE pin input current

I _{SEH}	15	mA
------------------	----	----

Recommended Operating Conditions

- Supply voltage V_{CC} 5.0 V ± 10 %
- Write current I_w 5 to 15 mAo-p

Sony reserves the right to change products and specifications without prior notice. This information does not convey any license by any implication or otherwise under any patents or other right. Application circuits shown, if any, are typical examples illustrating the operation of the devices. Sony cannot assume responsibility for any problems arising out of the use of these circuits.

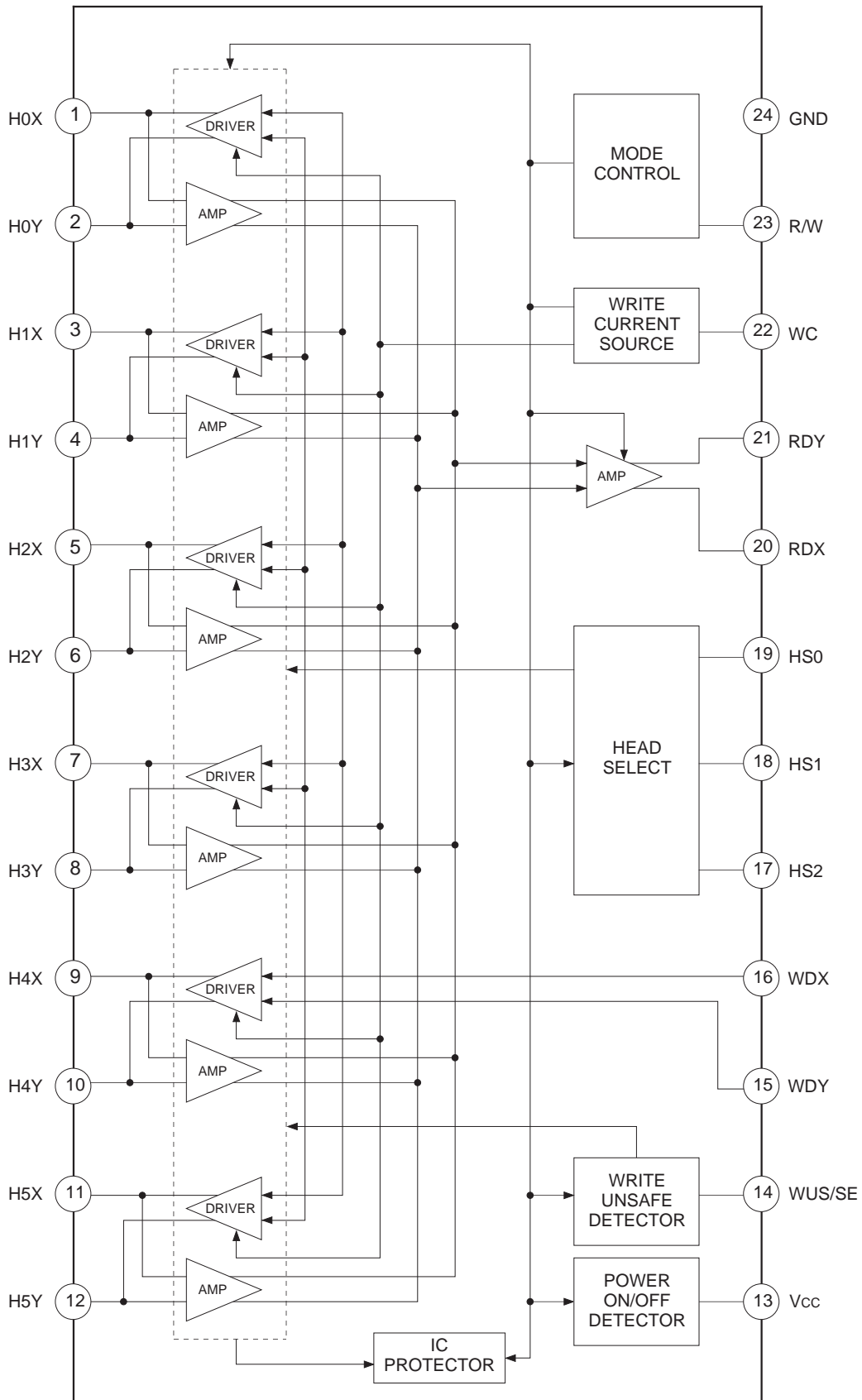

Pin Description

No.	Symbol	Equivalent circuit	Description
24	GND		
1 2 3 4 5 6 7 8 9 10 11 12	H0X H0Y H1X H1Y H2X H2Y H3X H3Y H4X H4Y H5X H5Y		Head. 6 channels provided.
14	WUS/SE		Write unsafe detection output / Servo Enable signal input.
15 16	WDY WDX		Differential P-ECL write data input.
13	Vcc		5 V power supply.

No.	Symbol	Equivalent circuit	Description
17 18 19	HS2 HS1 HS0		Head select signal input. Selects one of 6 heads according to Table 2.
23	R/W		Read/Write signal input At "High" : Read, at "Low" : Write.
20 21	RDX RDY		Read Amplifier output.
22	WC		A setting resistor for the write current value is connected between this pin and GND.

(Unless otherwise specified, $V_{CC}=5\text{ V}$, $T_a=25\text{ }^\circ\text{C}$, Write current $I_w=15\text{ mA}$)

Electrical Characteristics

No.	Item	Symbol	SW conditions																Measurement conditions	Min.	Typ.	Max.	Unit
			1	2	3	4	5	6	7	8	9	10	11	12	13	14	15	16					
1-1	Current consumption for Read	I_R	a	a	a	a	a	a	a	b	a	a	a	a	b	a	b	Test point : I ₂	12	17	26	mA	
1-2	Current consumption for Write	I_{WR}	a	a	a	a	a	a	a	b	a	a	a	a	b	a	a	Test point : I ₂	17 +I _w	23 +I _w	36 +I _w	mA	
2-1	Digital input "Low" input voltage	V_{IL}																Digital input : Pins 17, 18, 19, 23			0.8	V	
2-2	Digital input "High" input voltage	V_{IH}																	2.0			V	
2-3	Digital input "Low" input current	I_{IL}	a	a	a	a	a	a	b	a	a	a	a	a	b	a	a	"High" applied voltage : 5 V "Low" applied voltage : 0 V	-100			μA	
2-4	Digital input "High" input current	I_{IH}	a	a	a	a	a	a	b	a	b	b	b	b	b	b	b	Test point : I ₆ , I ₇ , I ₈ , I ₉			100	μA	
2-5	Write data input "Low" input voltage	V_{WDL}																	V_{WDH}		V_{WDH}	V	
2-6	Write data input "High" input voltage	V_{WDH}																	-2.0		-0.25	V	
2-7	Write data input current	I_{WD}	a	a	a	a	a	a	b	a	a	a	a	a	b	a	a	Input voltage : 4 V	V_{CC}		V_{CC}	μA	
2-8	Unselected head voltage	V_{unsel}																			0.3	V	
3-1	Write unsafe output saturation voltage	V_{WUS}	b	a	a	a	a	a	b	a	c	a	a	a	b	a	a	Output current : 1 mA Test point : V ₁			0.5	V	
3-2	Write unsafe output leak current	I_{WUS}	a	a	a	a	a	a	b	a	a	a	a	a	b	a	a	Test point : I ₃			50	μA	
4	Supply power ON/OFF detector threshold voltage	V_{TH}	b	a	a	a	a	a	a	b	a	a	a	a	b	a	a	When V_{CC} is lowered from 5 V in Write mode and I _w does not flow anymore, V_{CC} voltage is set to V_{THOFF} . When V_{CC} is raised from 3 V and I _w starts to flow, V_{CC} voltage is set to V_{THON} .	3.4	3.9	4.3	V	

No.	Item	Symbol	SW conditions																Measurement conditions	Min.	Typ.	Max.	Unit
			1	2	3	4	5	6	7	8	9	10	11	12	13	14	15	16					
5-1	Write current setting range	I _w																		5		15	mA _{o-p}
5-2	Write current voltage	V _{wc}	a	a	a	a	a	e	b	a	a	b	a	a	a	a	a	a	1.8	2	2.2	V	
5-3	Write current gain	A _w																	I _w =A _w • V _{wc} /R _{wc}	23.4	26	28.6	mA/mA
5-4	Write current setting constant	K _w	b	a	a	a	a	a	b	a	a	b	a	a	a	a	a	b	46.8	52	57.2		
6-1	WUS/SE voltage	V _{SEH}	b	a	a	a	a	a	b	a	a	b	a	a	a	a	b	a	V _{cc} +1		V _{cc} +1.2	V	
6-2	WUS/SE sink current	I _{SEH}	b	a	a	a	a	a	b	a	a	b	a	a	a	a	b	a	0.5		14	mA	
7	Read amplifier differential voltage gain	A _v	b	a	a	a	a	c	b	a	a	b	a	a	a	b	b		Input voltage SG1 : 1 mVp-p, 300 kHz Load resistance (RDX, RDY) : 1 kΩ Test point : V4 [Vp-p] $AV = \frac{V4}{SG1}$	275	325	375	V/V
8	Frequency band width (-3 dB)	BW	b	a	a	a	a	c	b	a	a	b	a	a	a	b	b		Frequency at which A _v lowers by 3 dB	70	100		MHz
9	Input referred noise	E _N	a	a	a	a	a	e	b	a	a	b	a	a	a	b	b		Head impedance : 0 Ω, when the read amplifier output voltage is amplified 100 times and voltage passed through a LPF (low pass filter of cutoff frequency 15 MHz) is V _N [Vrms], $EN = \frac{V_N}{100 \cdot AV \sqrt{15 \times 10^6}}$ Test point : V5	0.47	0.65		$\frac{nV}{\sqrt{Hz}}$

No.	Item	Symbol	SW conditions																Measurement conditions	Min.	Typ.	Max.	Unit
			1	2	3	4	5	6	7	8	9	10	11	12	13	14	15	16					
10	Common mode rejection ratio	CMRR	b	a	a	a	a	a	b	a	a	a	a	a	b	a	b	In-phase input voltage SG2 : 100 mVp-p, 5 MHz When the Read amplifier output is V_{CM} [mVp-p]. $CMRR = 20 \log \frac{100}{V_{CM}} \frac{100}{V_{CM}}$ +20 log A_v Test point : V_4	50			dB	
11	Power supply rejection ratio	PSRR	a	a	a	a	a	a	a	a	a	a	a	a	b	a	b	Ripple voltage SG3 : 100 mVp-p, 5 MHz When the Read amplifier output is V_P [mVp-p]. $PSRR = 20 \log \frac{100}{V_P} \frac{100}{V_P}$ +20 log A_v Test point : V_4	50			dB	
12	Channel separation	CS	a	b	a	a	a	a	a	b	a	a	a	a	b	a	b	Selected head input voltage : 0 mVp-p Unselected head input voltage SG1 : 100 mVp-p, 5 MHz When the Read amplifier output is V_{CS} [mVp-p]. $CS = 20 \log \frac{100}{V_{CS}} \frac{100}{V_{CS}}$ +20 log A_v Test point : V_4	50			dB	
13	Read data output offset voltage for Read	V_{OFFR}	a	a	a	a	a	a	a	b	a	a	a	a	b	a	b	$V_{OFFR} = V_2 - V_3$ Test point : V_2, V_3	-250		250	mV	

Unless otherwise specified, $V_{CC}=5\text{ V}$, $T_a=25\text{ }^\circ\text{C}$, f_{WD} (Write data frequency) =5 MHz, $I_W=15\text{ mA}$, L_H (Head inductance) =1 μH , R_H (Head DC resistance value) =30 Ω

Refer to Fig. 2 to Fig. 4

No.	Item	Symbol	Measurement conditions	Min.	Typ.	Max.	Unit
14	Head differential voltage amplitude	V_{SW}	Differential voltage between HX pin and HY pin at switching of Write current (open Head)	5.8	6.8		Vp-p
15-1	Mode switching time Read to Write	T_{RW}	T_{RW} is the time required for Write current to turn to 90 % after Pin 23 changes from "High" to "Low".		0.2	0.4	μs
15-2	Mode switching time Write to Read	T_{WR1}	T_{WR1} is the time required for the Read amplifier output* to turn to 90 % after Pin 23 changes from "Low" to "High".		0.3	0.5	μs
		T_{WR2}	T_{WR2} is the time required for Write current to decrease to 10 % after Pin 23 changes from "Low" to "High".		0.2	0.4	μs
16-1	Mode switching time safe to unsafe	T_{SA1}	T_{SA1} is the time required for Pin 14 to turn "High" after the last transition of Write data when Write data is stopped in Write mode.	1.5	3	5	μs
16-2	Mode switching time unsafe to safe	T_{SA2}	T_{SA2} is the time required for Pin 14 to turn "Low" after the first transition of Write data in Write mode.			0.6	μs
17	Head switching time	T_H	T_H is the time required for the Read amplifier output* to reach 90 % when the selected head switched in Read mode.			0.6	μs
18	Write current propagation delay time	T_{PD}	T_{PD} is the time required for Write current to reach 90 % after the Write data falling edge.		2	7	ns
19	Write current rise/fall time	T_R/T_F	$L_H=0\text{ }\mu\text{H}$, $R_H=0\text{ }\Omega$ T_R is the time required for Write current to reach 90 % from 10 %; T_F is the same time required		1	3	ns

*Read amplifier output 100 mVp-p 10 MHz

Timing Chart 1

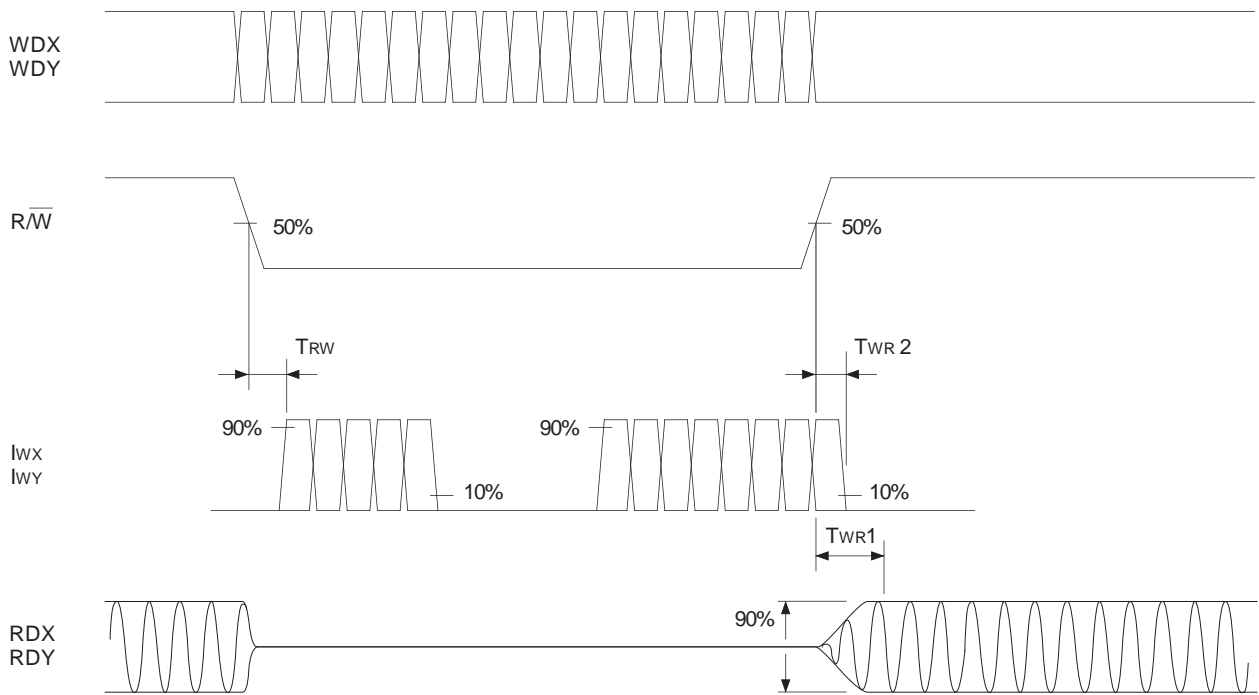

Fig. 3

Timing Chart 2

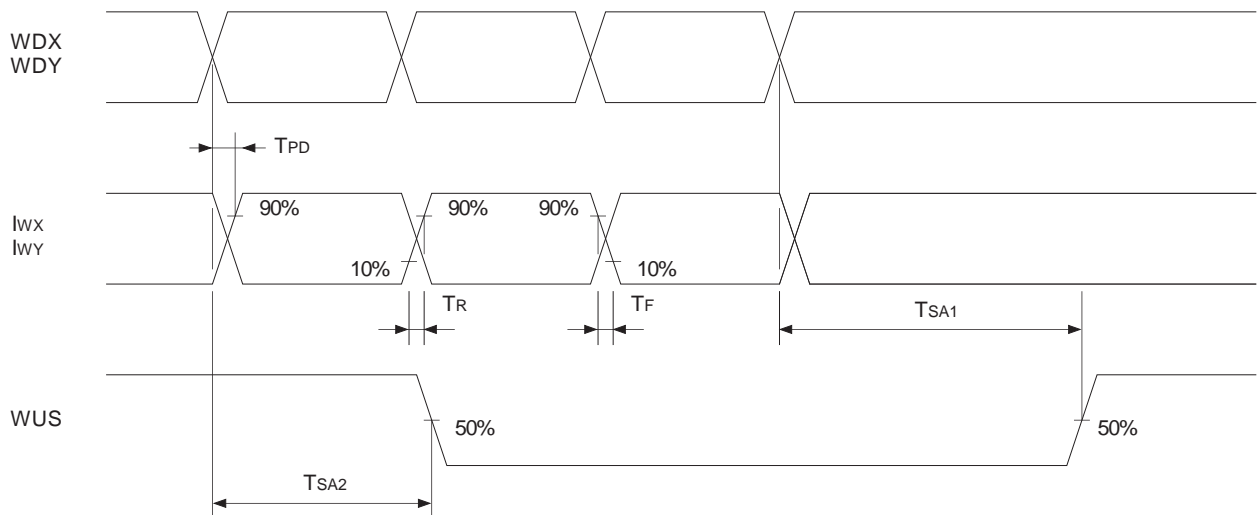

Fig. 4

Description Functions

Read amplifier

This is a low noise amplifier for amplifying the signals from the heads with an emitter follower output.

The RDX and RDY are the outputs of the differential amplifier whose polarity between the RDX and X side of the head input is same.

Write circuit

The Write data input to WDX pin and WDY pin passes through the buffer amp. It drives the Write switch circuit which supplies the Write current to the heads.

The Write current flows into the X side when WDX is "Low" and WDY is "High".

Mode control

The mode are set as shown Table 1 by $\overline{R/W}$ and WUS/SE.

R/W	WUS/SE	HS0	HS1	HS2	Mode
L	X	See Table 2			Write
H	X				Read
L	**	See Table 3	X		Servo Write

Table 1. Mode selection

Head selection

The heads are selected as shown in Table 2 by the HS0, HS1 and HS2 pins.

HS0	HS1	HS2	Head
L	L	L	0
H	L	L	1
L	H	L	2
H	H	L	3
L	L	H	4
H	L	H	5

Table 2. Head selection

Servo write mode **

This mode allows for writing to multiple channels at once.

To enable servo write mode follow these steps:

- (1) Place the device in the Read mode.
- (2) Set HS0 and HS1 following Table 3.
- (3) Set WUS/SE to V_{SEH} , or input I_{SEH} to WUS/SE.
- (4) While maintaing step (2) and (3) above make R/W low, placing the device in servo write mode.

Write unsafe detection circuit

This circuit detects write errors.

In normal Write mode, the WUS output is low; in the conditions listed below, it is high.

- Head inputs is open (under the condition which. $RH=\infty$ and Write data frequency is ≤ 10 MHz)
- Head input is shorted to GND or VCC.
- Write data frequency is abnormally low.
- No write current.
- In read mode.
- Supply voltage is abnormal (see power supply ON/OFF detection).

Power supply ON/OFF detection

This circuit monitors V_{CC} to detect erroneous Writes. The error status is established when V_{CC} falls below the threshold voltage (V_{th}) of the power supply ON/OFF detector, in which case the recording and playback functions are prohibited. When V_{CC} rises above, V_{TH} , the prohibition of these functions is released.

HS0	HS1	Head
L	L	0, 1, 2
H	L	0, 1, 2, 3, 4, 5
L	H	3, 4, 5
H	H	0, 1, 2, 3, 4, 5

Table 3. Head selection in Servo Write mode

Application Circuit

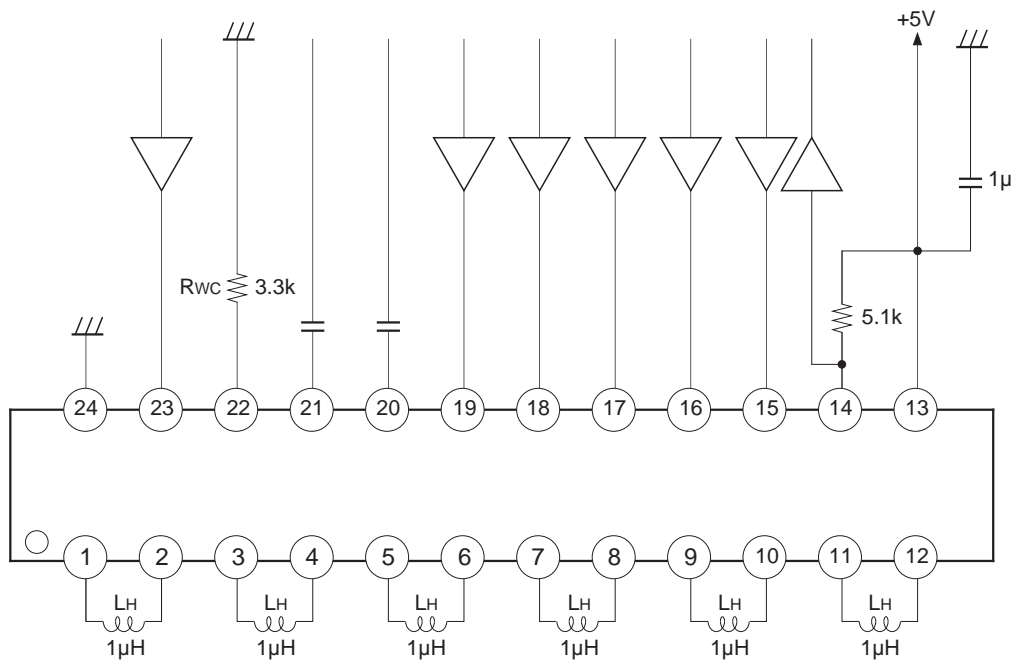

Application circuits shown are typical examples illustrating the operation of the devices. Sony cannot assume responsibility for any problems arising out of the use of these circuits or for any infringement of third party patent and other right due to same.

Notes on operation

- This device handles high frequency and high gain signals. Please note the following;
 - ◆ Connect Vcc decoupling capacitor of approximately 1000 pF near the device.
 - ◆ Make the GND area as large as possible.
- When using as 2 or 4-channel, short-circuit the X and Y sides of unused head pins or leave them open.
- The WC pin is a constant voltage pin. When noise affects this pin, it creates noise in Write c current. Therefore, locate Rwc as close to the device as possible.

- Write unsafe detection circuit

This circuit uses the voltage waveforms of the head pins for detection.

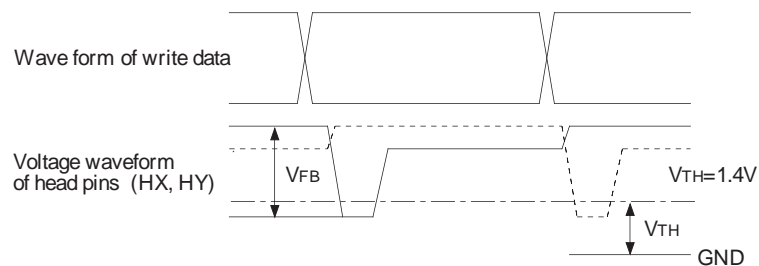

- ◆ V_{FB} must be more than 2 V. When $V_{FB} < 2 V$, it is possible that Write unsafe detection maximum frequency becomes more than 1 MHz.
- ◆ The normal operating area of write unsafe detection circuit is changed by head inductance, head DC resistance, write current and other.

Application Notes

Use the following characteristics for reference.

V_{CC}=5V, T_a=25 °C

Item		Symbol	Conditions	Min.	Typ.	Max.	Unit
Write mode	Differential output capacitance	C _O	Between head input pins			10	pF
	Differential output resistance	R _O		260	350	440	Ω
Read mode	Differential input capacitance	C _I	Between head input pins f=5 MHz		6	10	pF
	Differential input resistance	R _I		0.6	1.2		kΩ
	Output resistance	R _{RD}	RDX or RDY, f=5 MHz			50	Ω
Unselected head differential current in Write mode		I _{US}	L _H =1 μH, R _H =30 Ω I _W =15 mA			0.2	mAp-p
Write current symmetry		T _{AS} *	L _H =0 μH, R _H =0 Ω I _W =15 mA	-0.5		0.5	ns

*T_{AS}=T₁-T₂

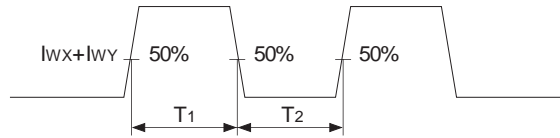

Setting of Write current

Write current can be set with resistor R_{wc} (kΩ) at Pin 22.

I_w=K/R_{wc} (mA) Refer to Fig. 5.

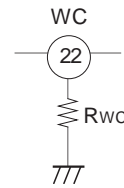
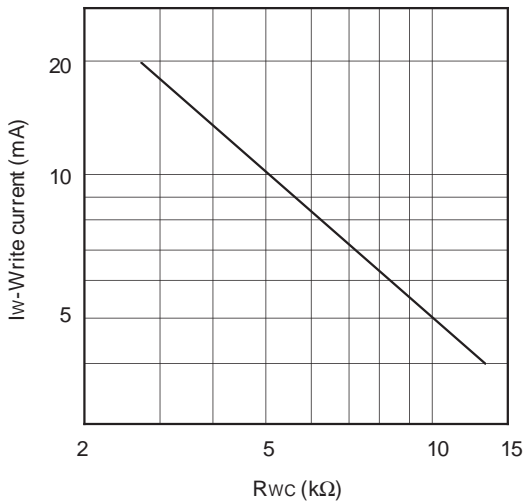
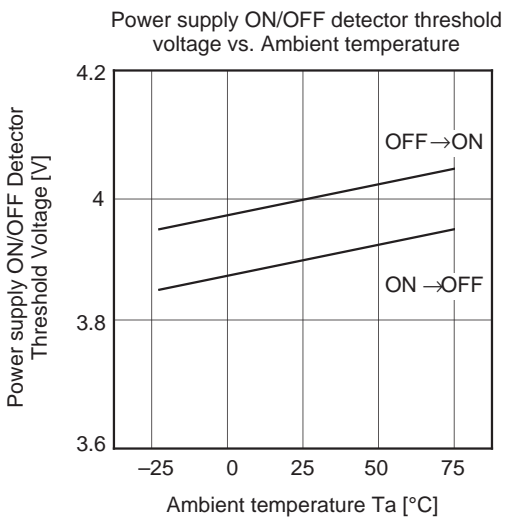
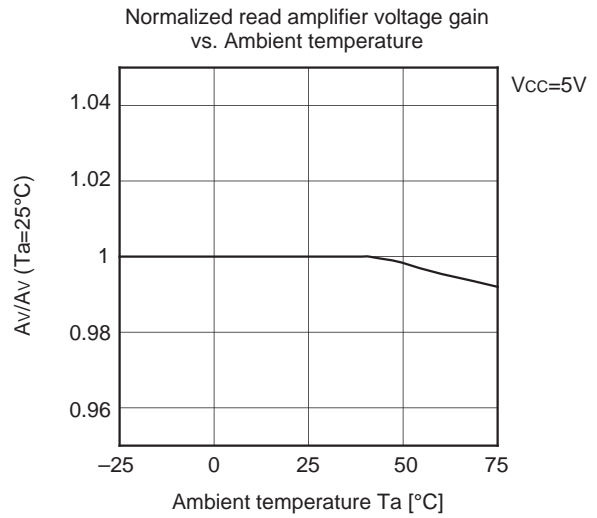
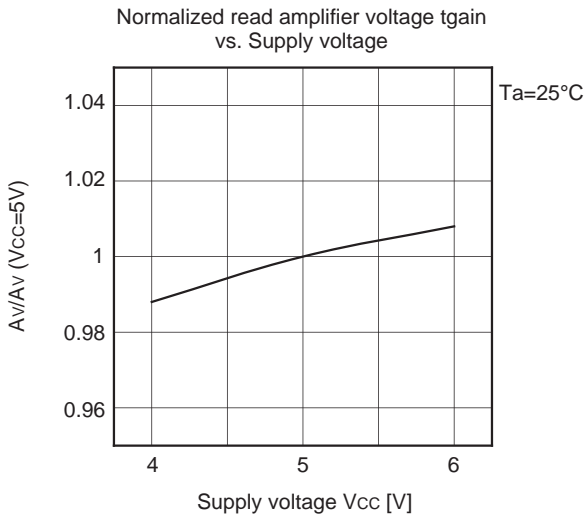
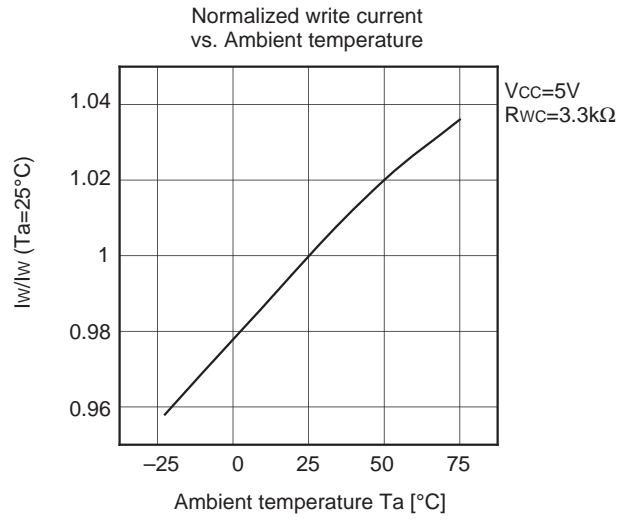
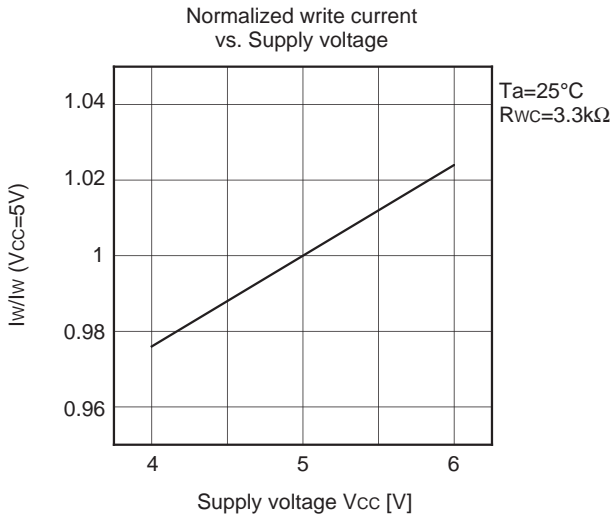

Fig.5 Write current vs. R_{wc}





Package Outline Unit : mm

24PIN SSOP(PLASTIC)

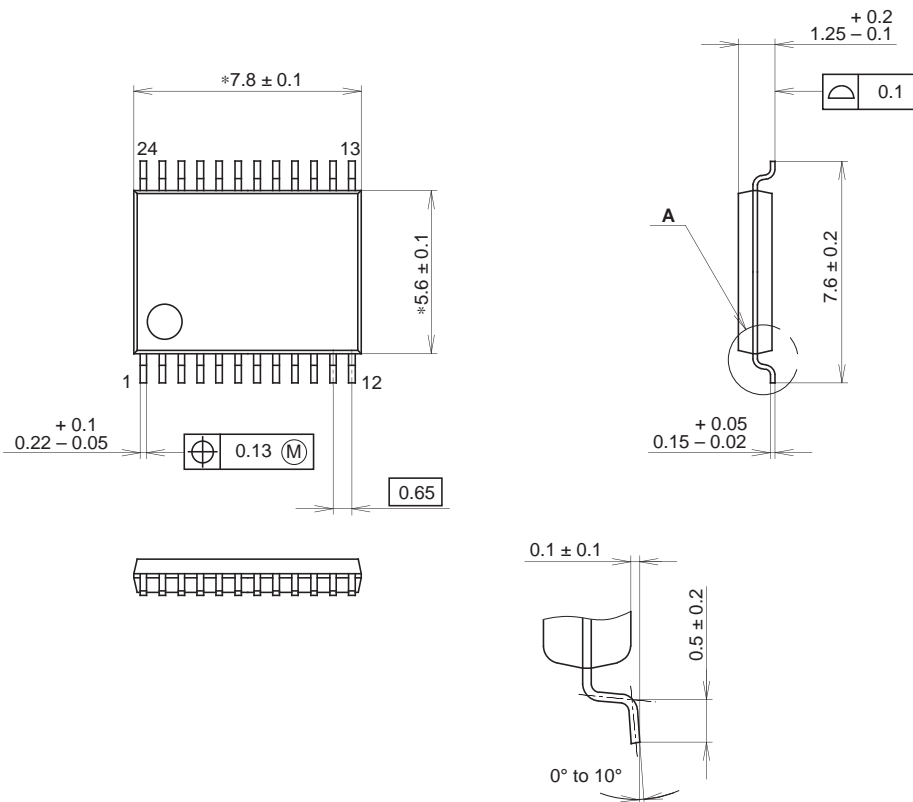

NOTE: Dimensions "*" does not include mold protrusion.

DETAIL A

PACKAGE STRUCTURE

SONY CODE	SSOP-24P-L01
EIAJ CODE	SSOP024-P-0056
JEDEC CODE	_____

PACKAGE MATERIAL	EPOXY RESIN
LEAD TREATMENT	SOLDER/PALLADIUM PLATING
LEAD MATERIAL	42/COPPER ALLOY
PACKAGE MASS	0.1g