

CD Digital Signal Processor with Built-in Digital Servo

**Description**

The CXD2585Q is a digital signal processor LSI for CD players. This LSI incorporates a digital servo.

**Features**

- All digital signal processings during playback are performed with a single chip
- Highly integrated mounting possible due to a built-in RAM

**Digital Signal Processor (DSP) Block**

- Playback mode supporting CAV (Constant Angular Velocity)
  - Frame jitter free
  - 0.5× to 4× continuous playback possible
  - Allows relative rotational velocity readout
- Wide capture range playback mode
  - Spindle rotational velocity following method
  - Supports 1× to 4× playback variable pitch playback
- Bit clock, which strobes the EFM signal, is generated by the digital PLL.
- EFM data demodulation
- Enhanced EFM frame sync signal protection
- Refined super strategy-based powerful error correction
  - C1: double correction, C2: quadruple correction
  - Supported during 4× playback
- Noise reduction during track jumps
- Auto zero-cross mute
- Subcode demodulation and Sub-Q data error detection
- Digital spindle servo
- 16-bit traverse counter
- Asymmetry correction circuit
- CPU interface on serial bus
- Error correction monitor signal, etc. output from a new CPU interface
- Servo auto sequencer
- Fine search performs track jumps with high accuracy
- Digital audio interface output
- Digital level meter, peak meter
- Bilingual supported
- VCO control mode
- CD TEXT data demodulation

**Digital Servo (DSSP) Block**

- Microcomputer software-based flexible servo control
- Offset cancel function for servo error signal
- Auto gain control function for servo loop
- E:F balance, focus bias adjustment function
- Surf jump function supporting micro two-axis
- Tracking filter: 6 stages
- Focus filter: 5 stages

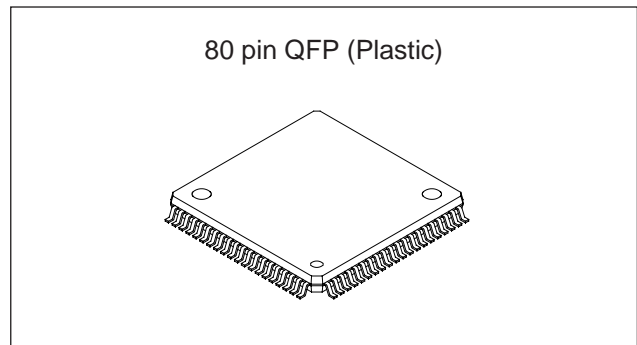

**Applications**

CD players

**Structure**

Silicon gate CMOS IC

**Absolute Maximum Ratings**

- Supply voltage  $V_{DD}$  -0.3 to +7.0 V
- Input voltage  $V_I$  -0.3 to +7.0 V  
( $V_{SS} - 0.3$  to  $V_{DD} + 0.3$ ) V
- Output voltage  $V_O$  -0.3 to +7.0 V
- Storage temperature  $T_{stg}$  -40 to +125 °C
- Supply voltage difference  $V_{SS} - AV_{SS}$  -0.3 to +0.3 V  
 $V_{DD} - AV_{DD}$  -0.3 to +0.3 V

**Recommended Operating Conditions**

- Supply voltage  $V_{DD}$  2.7 to 5.5 V
- Operating temperature  $T_{opr}$  -20 to +75 °C

**Note)** The  $V_{DD}$  for the CXD2585Q varies according to the playback speed.

Playback speed	$V_{DD}$ [V]
	CD-DSP block
4× speed	4.75 to 5.25
2× speed	3.0 to 5.5
1× speed	2.7 to 5.5

**Input/Output Capacitance**

- Input capacitance  $C_i$  12 (Max.) pF
- Output capacitance  $C_o$  12 (Max.) pF

**Note)** Measurement conditions  $V_{DD} = V_I = 0V$   
 $f_M = 1MHz$

Sony reserves the right to change products and specifications without prior notice. This information does not convey any license by any implication or otherwise under any patents or other right. Application circuits shown, if any, are typical examples illustrating the operation of the devices. Sony cannot assume responsibility for any problems arising out of the use of these circuits.

Block Diagram

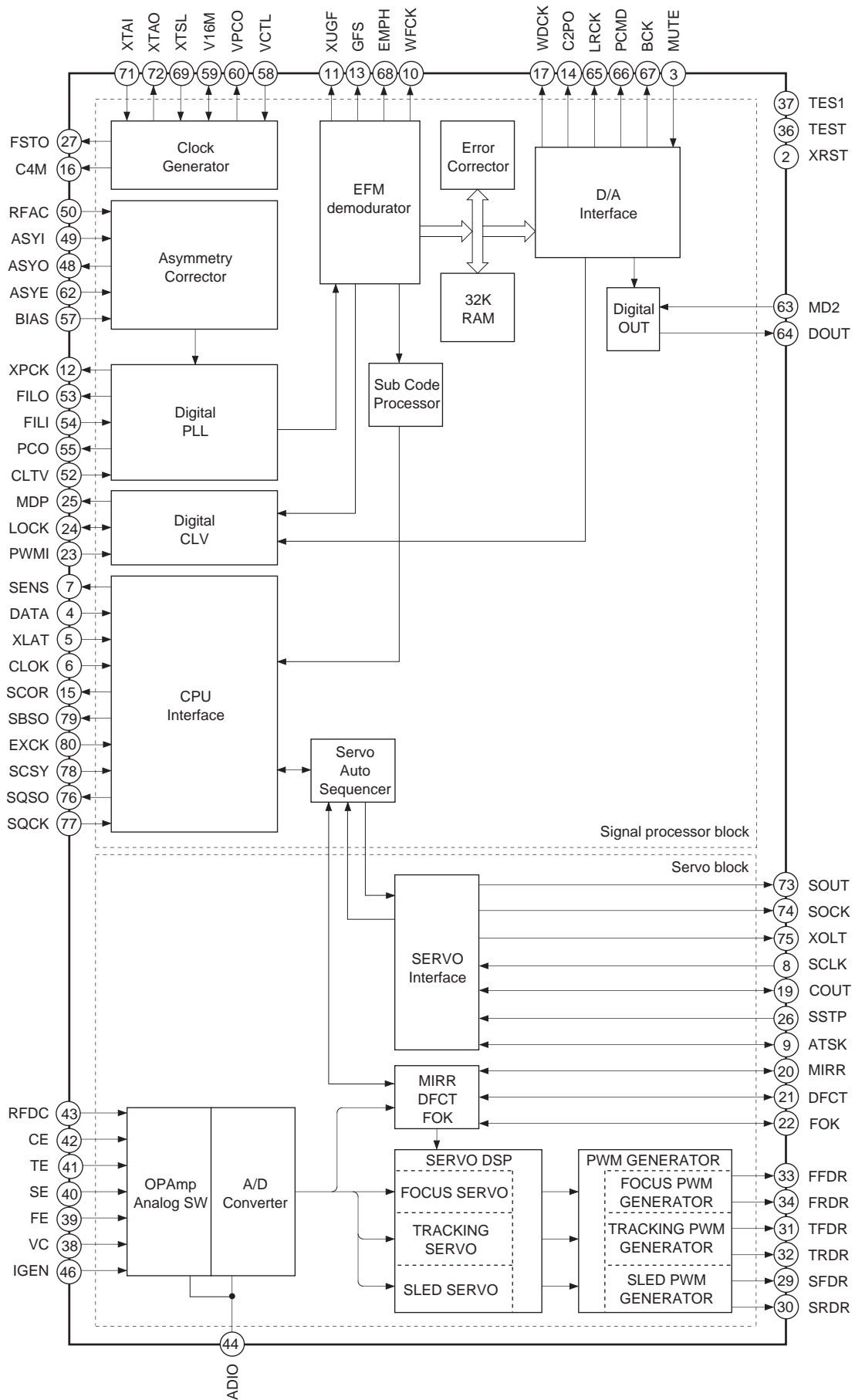

Pin Configuration

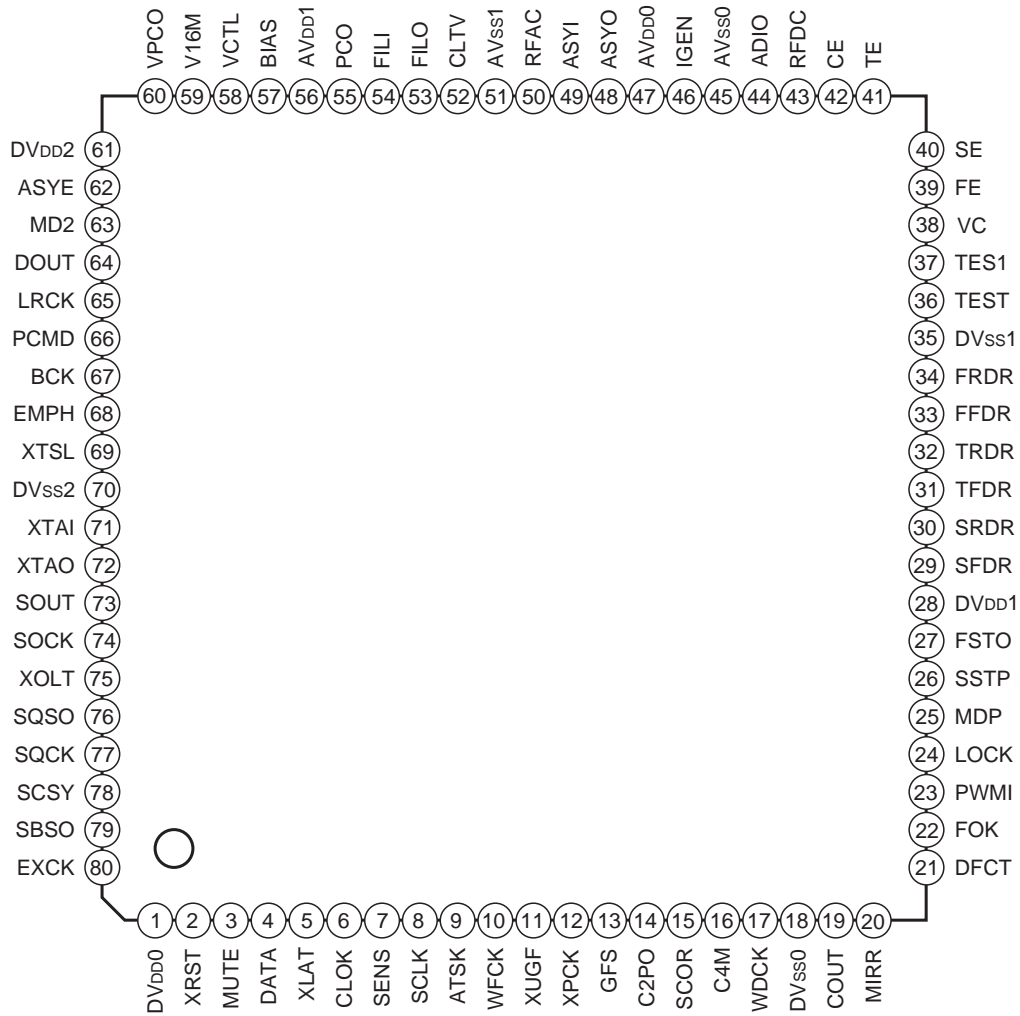

## Pin Description

Pin No.	Symbol	I/O		Description
1	DV <sub>DD0</sub>	—		Digital power supply.
2	XRST	I		System reset. Reset when low.
3	MUTE	I		Mute input (low: off, high: on)
4	DATA	I		Serial data input from CPU.
5	XLAT	I		Latch input from CPU. Serial data is latched at the falling edge.
6	CLOK	I		Serial data transfer clock input from CPU.
7	SENS	O	1, 0	SENS output to CPU.
8	SCLK	I		SENS serial data readout clock input.
9	ATSK	I/O	1, 0	Anti-shock input/output.
10	WFCK	O	1, 0	WFCK output.
11	XUGF	O	1, 0	XUGF output. MNT0 or RFCK is output by switching with the command.
12	XPCK	O	1, 0	XPCK output. MNT1 is output by switching with the command.
13	GFS	O	1, 0	GFS output. MNT2 or XROF is output by switching with the command.
14	C2PO	O	1, 0	G2PO output. MNT3 or GTOP is output by switching with the command.
15	SCOR	O	1, 0	Outputs a high signal when either subcode sync S0 or S1 is detected.
16	C4M	O	1, 0	4.2336MHz output. 1/4 frequency division output for V16M in CAV-W mode or variable pitch mode.
17	WDCK	O	1, 0	Word clock output. $f = 2Fs$ . GRSCOR is output by the command switching.
18	DV <sub>ss0</sub>	—	—	Digital GND.
19	COUT	I/O	1, 0	Track count signal I/O.
20	MIRR	I/O	1, 0	Mirror signal I/O.
21	DFCT	I/O	1, 0	Detect signal I/O.
22	FOK	I/O	1, 0	Focus OK signal I/O.
23	PWMI	I		Spindle motor external control input.
24	LOCK	I/O	1, 0	GFS is sampled at 460Hz; when GFS is high, this pin outputs a high signal. If GFS is low eight consecutive samples, this pin outputs low. Input when LKIN = 1.
25	MDP	O	1, Z, 0	Spindle motor servo control output.
26	SSTP	I		Disc innermost track detection signal input.
27	FSTO	O	1, 0	2/3 frequency division output for XTAL pin.
28	DV <sub>DD1</sub>	—	—	Digital power supply.
29	SFDR	O	1, 0	Sled drive output.
30	SRDR	O	1, 0	Sled drive output.
31	TFDR	O	1, 0	Tracking drive output.
32	TRDR	O	1, 0	Tracking drive output.
33	FFDR	O	1, 0	Focus drive output.
34	FRDR	O	1, 0	Focus drive output.
35	DV <sub>ss1</sub>	—	—	Digital GND.

Pin No.	Symbol	I/O		Description
36	TEST	I		Test. Normally, GND.
37	TES1	I		Test. Normally, GND.
38	VC	I		Center voltage input.
39	FE	I		Focus error signal input.
40	SE	I		Sled error signal input.
41	TE	I		Tracking error signal input.
42	CE	I		Center servo analog input.
43	RFDC	I		RF signal input.
44	ADIO	O	Analog	Test. No connected.
45	AVss0	—	—	Analog GND.
46	IGEN	I		Constant current input for operational amplifier.
47	AVDD0	—	—	Analog power supply.
48	ASYO	O	1, 0	EFM full-swing output. (low = Vss, high = VDD)
49	ASYI	I		Asymmetry comparator voltage input.
50	RFAC	I		EFM signal input.
51	AVss1	—	—	Analog GND.
52	CLTV	I		Multiplier VCO1 control voltage input.
53	FILO	O	Analog	Master PLL filter output (slave = digital PLL).
54	FILI	I		Master PLL filter input.
55	PCO	O	1, Z, 0	Master PLL charge pump output.
56	AVDD1	—	—	Analog power supply.
57	BIAS	I		Asymmetry circuit constant current input.
58	VCTL	I		Wide-band EFM PLL VCO2 control voltage input.
59	V16M	I/O	1, 0	Wide-band EFM PLL VCO2 oscillation output. Serves as wide-band EFM PLL clock input by switching with the command.
60	VPCO	O	1, Z, 0	Wide-band EFM PLL charge pump output.
61	DVDD2	—	—	Digital power supply.
62	ASYE	I		Asymmetry circuit on/off (low = off, high = on).
63	MD2	I		Digital Out on/off control (low = off, high = on).
64	DOUT	O	1, 0	Digital Out output.
65	LRCK	O	1, 0	D/A interface. LR clock output. $f = F_s$
66	PCMD	O	1, 0	D/A interface. Serial data output (two's complement, MSB first).
67	BCK	O	1, 0	D/A interface. Bit clock output.
68	EMPH	O	1, 0	Outputs a high signal when the playback disc has emphasis, and a low signal when there is no emphasis.
69	XTSL	I		Crystal selection input. Low when the crystal is 16.9344MHz; high when it is 33.8688MHz.
70	DVss2	—	—	Digital GND.

Pin No.	Symbol	I/O		Description
71	XTAI	I		Crystal oscillation circuit input. When the master clock is input externally, input it from this pin.
72	XTAO	O		Crystal oscillation circuit output.
73	SOUT	O	1, 0	Serial data output in servo block.
74	SOCK	O	1, 0	Serial data readout clock output in servo block.
75	XOLT	O	1, 0	Serial data latch output in servo block.
76	SQSO	O	1, 0	Sub-Q 80-bit, PCM peak or level data outputs. CD TEXT data output.
77	SQCK	I		SQSO readout clock input.
78	SCSY	I		GRSCOR resynchronization input.
79	SBSO	O	1, 0	Sub-Q P to W serial output.
80	EXCK	I		SBSO readout clock input.

**Notes)**

- PCMD is a MSB first, two's complement output.
- GTOP is used to monitor the frame sync protection status. (High: sync protection window released.)
- XUGF is the frame sync obtained from the EFM signal, and is negative pulse. It is the signal before sync protection.
- XPCK is the inverse of the EFM PLL clock. The PLL is designed so that the falling edge and the EFM signal transition point coincide.
- The GFS signal goes high when the frame sync and the insertion protection timing match.
- RFCK is derived from the crystal accuracy, and has a cycle of 136µs. (during normal speed)
- C2PO represents the data error status.
- XROF is generated when the 32K RAM exceeds the ±28F jitter margin.

**Combination of Monitor Pin Outputs**

Command bit		Output data			
MTSL1	MTSL0				
0	0	XUGF	XPCK	GFS	C2PO
0	1	MNT0	MNT1	MNT2	MNT3
1	0	RFCK	XPCK	XROF	GTOP

## Electrical Characteristics

## 1. DC Characteristics

(V<sub>DD</sub> = AV<sub>DD</sub> = 5.0V ± 5%, V<sub>SS</sub> = AV<sub>SS</sub> = 0V, T<sub>opr</sub> = -20 to +75°C)

Item			Conditions	Min.	Typ.	Max.	Unit	Applicable pins
Input voltage (1)	High level input voltage	V <sub>IH</sub> (1)		0.7V <sub>DD</sub>			V	*1, *9
	Low level input voltage	V <sub>IL</sub> (1)				0.3V <sub>DD</sub>	V	
Input voltage (2)	High level input voltage	V <sub>IH</sub> (2)	Schmitt input	0.8V <sub>DD</sub>			V	*2, *10
	Low level input voltage	V <sub>IL</sub> (2)				0.2V <sub>DD</sub>	V	
Input voltage (3)	Input voltage	V <sub>IN</sub> (3)	Analog input	V <sub>SS</sub>		V <sub>DD</sub>	V	*3, *7, *8
Output voltage (1)	High level output voltage	V <sub>OH</sub> (1)	I <sub>OH</sub> = -2mA	V <sub>DD</sub> - 0.8		V <sub>DD</sub>	V	*4
	Low level output voltage	V <sub>OL</sub> (1)	I <sub>OL</sub> = 4mA	V <sub>SS</sub>		0.4	V	
Output voltage (2)	High level output voltage	V <sub>OH</sub> (2)	I <sub>OH</sub> = -6mA	V <sub>DD</sub> - 0.8		V <sub>DD</sub>	V	*5
	Low level output voltage	V <sub>OL</sub> (2)	I <sub>OL</sub> = 4mA	V <sub>SS</sub>		0.4	V	
Output voltage (3)	High level output voltage	V <sub>OH</sub> (3)	I <sub>OH</sub> = -0.28mA	V <sub>DD</sub> - 0.5		V <sub>DD</sub>	V	*6
	Low level output voltage	V <sub>OL</sub> (3)	I <sub>OL</sub> = 0.36mA	V <sub>SS</sub>		0.4	V	
Input leak current (1)		I <sub>LI</sub> (1)	V <sub>IN</sub> = V <sub>SS</sub> or V <sub>DD</sub>	-10		10	μA	*1, *2
Input leak current (2)		I <sub>LI</sub> (2)	V <sub>IN</sub> = V <sub>SS</sub> or V <sub>DD</sub>	-40		40	μA	*9, *10
Input leak current (3)		I <sub>LI</sub> (3)	V <sub>I</sub> = 1.5 to 3.5V	-20		20	μA	*7
Input leak current (4)		I <sub>LI</sub> (4)	V <sub>I</sub> = 0 to 5.0V	-40		600	μA	*8

## Applicable pins

\*1 MUTE, DATA, XLAT, SSTP, TEST, TES1, MD2, XTSL, SCSY

\*2 SQCK, XRST, CLOK, ASYE

\*3 ASYI, RFAC, CLTV, FILI, VCTL

\*4 SQSO, SBSO, SENS, ATSK, WFCK, XUGF, XPCK, GFS, C2PO, SCOR, C4M, WDCK, COUT, MIRR, DFCT, FOK, LOCK, FSTO, SFDR, SRDR, TFDR, TRDR, FFDR, FRDR, ASYO, V16M, DOUT, LRCK, PCMD, BCK, EMPH, SOUT, SOCK, XOLT

\*5 MDP, PCO, VPCO

\*6 FILO

\*7 VC, FE, SE, TE, CE

\*8 RFDC

\*9 PWMI, EXCK, ATSK, COUT, MIRR, DFCT, FOK, LOCK, V16M

\*10 SCLK, FSTO

2. AC Characteristics

(1) XTAI pin

(a) When using self-excited oscillation

(Topr = -20 to +75°C, VDD = AVDD = 5.0V ± 5%)

Item	Symbol	Min.	Typ.	Max.	Unit
Oscillation frequency	f <sub>MAX</sub>	7		34	MHz

(b) When inputting pulses to XTAI pin

(Topr = -20 to +75°C, VDD = AVDD = 5.0V ± 5%)

Item	Symbol	Min.	Typ.	Max.	Unit
High level pulse width	t <sub>WHX</sub>	13		500	ns
Low level pulse width	t <sub>WLX</sub>	13		500	ns
Pulse cycle	t <sub>CX</sub>	26		1000	ns
Input high level	V <sub>IHX</sub>	V <sub>DD</sub> - 1.0			V
Input low level	V <sub>ILX</sub>			0.8	V
Rise time, fall time	t <sub>R</sub> , t <sub>F</sub>			10	ns

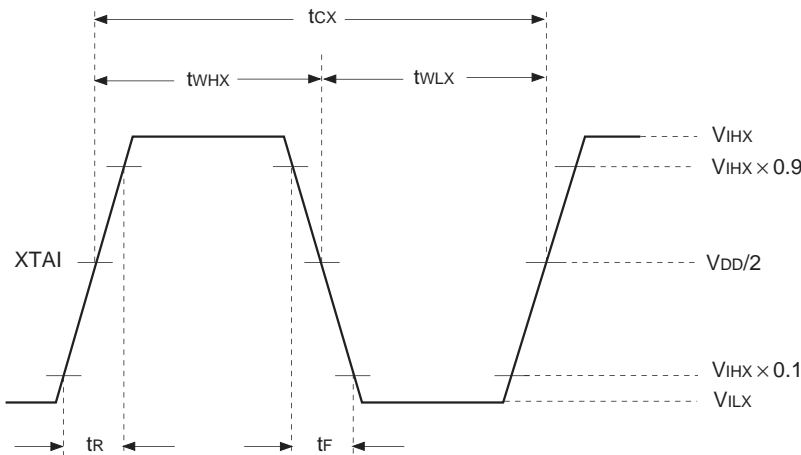

(c) When inputting sine waves to XTAI pin via a capacitor

(Topr = -20 to +75°C, VDD = AVDD = 5.0V ± 5%)

Item	Symbol	Min.	Typ.	Max.	Unit
Input amplitude	V <sub>I</sub>	2.0		V <sub>DD</sub> + 0.3	V <sub>p-p</sub>



(2) CLOK, DATA, XLAT, SQCK and EXCK pins

( $V_{DD} = AV_{DD} = 5.0V \pm 5\%$ ,  $V_{SS} = AV_{SS} = 0V$ ,  $T_{opr} = -20$  to  $+75^{\circ}C$ )

Item	Symbol	Min.	Typ.	Max.	Unit
Clock frequency	f <sub>ck</sub>			0.65	MHz
Clock pulse width	t <sub>wck</sub>	750			ns
Setup time	t <sub>su</sub>	300			ns
Hold time	t <sub>h</sub>	300			ns
Delay time	t <sub>d</sub>	300			ns
Latch pulse width	t <sub>wl</sub>	750			ns
EXCK SQCK frequency	f <sub>r</sub>			0.65	MHz
EXCK SQCK pulse width	t <sub>wT</sub>	750			ns
COUT frequency (for input) *	f <sub>r</sub>			65	kHz
COUT pulse width (for input) *	t <sub>wT</sub>	7.5			μs

\* Only when \$44 and \$45 are executed.

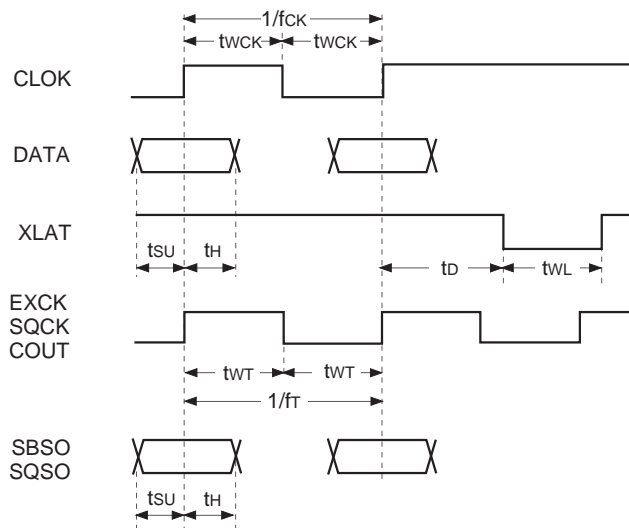

(3) SCLK pin

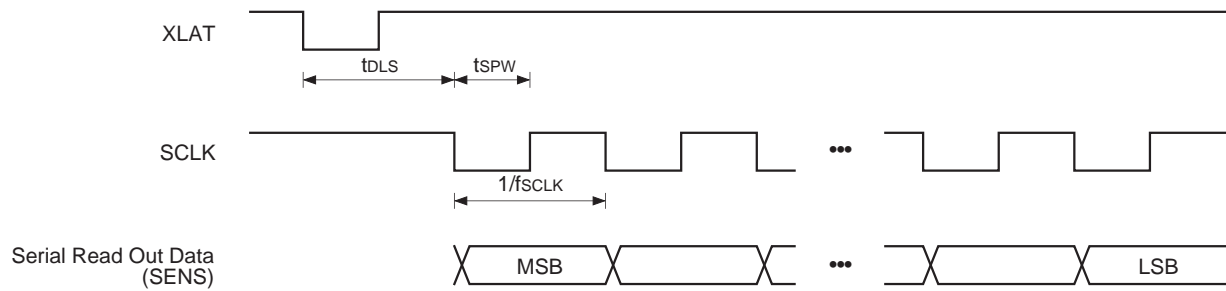

Item	Symbol	Min.	Typ.	Max.	Unit
SCLK frequency	$f_{SCLK}$			16	MHz
SCLK pulse width	$t_{SPW}$	31.3			ns
Delay time	$t_{DLS}$	15			$\mu$ s

(4) COUT, MIRR and DFCT pins

**Operating frequency**

( $V_{DD} = AV_{DD} = 5.0V \pm 5\%$ ,  $V_{SS} = AV_{SS} = 0V$ ,  $T_{opr} = -20$  to  $+75^{\circ}C$ )

Signal	Symbol	Min.	Typ.	Max.	Unit	Conditions
COUT maximum operating frequency	$f_{COUT}$	40			kHz	*1
MIRR maximum operating frequency	$f_{MIRR}$	40			kHz	*2
DFCT maximum operating frequency	$f_{DFCTH}$	5			kHz	*3

\*1 When using a high-speed traverse TZC.

\*2

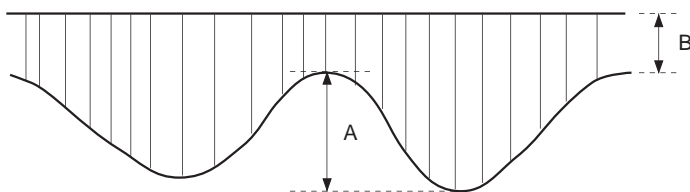

When the RF signal continuously satisfies the following conditions during the above traverse.

- $A = 0.12V_{DD}$  to  $0.26V_{DD}$
- $\frac{B}{A + B} \leq 25\%$

\*3 During complete RF signal omission.

When settings related to DFCT signal generation are Typ.

## Contents

<b>[1] CPU Interface</b>	
§ 1-1. CPU Interface Timing .....	12
§ 1-2. CPU Interface Command Table .....	12
§ 1-3. CPU Command Presets .....	23
§ 1-4. Description of SENS Signals .....	29
<b>[2] Subcode Interface</b>	
§ 2-1. P to W Subcode Readout .....	53
§ 2-2. 80-bit Sub-Q Readout .....	53
<b>[3] Description of Modes</b>	
§ 3-1. CLV-N Mode .....	60
§ 3-2. CLV-W Mode .....	60
§ 3-3. CAV-W Mode .....	60
§ 3-4. VCO-C mode .....	61
<b>[4] Description of Other Functions</b>	
§ 4-1. Channel Clock Regeneration by Digital PLL Circuit .....	64
§ 4-2. Frame Sync Protection .....	66
§ 4-3. Error Correction .....	66
§ 4-4. DA Interface .....	67
§ 4-5. Digital Out .....	69
§ 4-6. Servo Auto Sequence .....	70
§ 4-7. Digital CLV .....	78
§ 4-8. Playback Speed .....	79
§ 4-9. Asymmetry Correction .....	80
§ 4-10. CD TEXT Data Demodulation .....	81
<b>[5] Description of Servo Signal Processing System Functions and Commands</b>	
§ 5-1. General Description of Servo Signal Processing System .....	83
§ 5-2. Digital Servo Block Master Clock (MCK) .....	84
§ 5-3. DC Offset Cancel [AVRG Measurement and Compensation] .....	85
§ 5-4. E: F Balance Adjustment Function .....	86
§ 5-5. FCS Bias Adjustment Function .....	86
§ 5-6. AGCNTL Function .....	88
§ 5-7. FCS Servo and FCS Search .....	90
§ 5-8. TRK and SLD Servo Control .....	91
§ 5-9. MIRR and DFCT Signal Generation .....	92
§ 5-10. DFCT Countermeasure Circuit .....	93
§ 5-11. Anti-Shock Circuit .....	93
§ 5-12. Brake Circuit .....	94
§ 5-13. COUT Signal .....	95
§ 5-14. Serial Readout Circuit .....	95
§ 5-15. Writing to Coefficient RAM .....	96
§ 5-16. PWM Output .....	96
§ 5-17. Servo Status Changes Produced by LOCK Signal .....	97
§ 5-18. Description of Commands and Data Sets .....	97
§ 5-19. List of Servo Filter Coefficients .....	117
§ 5-20. Filter Composition .....	119
§ 5-21. TRACKING and FOCUS Frequency Response .....	125
<b>[6] Application Circuit</b> .....	126

Explanation of abbreviations	AVRG:	Average
	AGCNTL:	Auto gain control
	FCS:	Focus
	TRK:	Tracking
	SLD:	Sled
	DFCT:	Defect

[1] CPU Interface

§ 1-1. CPU Interface Timing

• CPU interface

This interface uses DATA, CLOK and XLAT to set the modes.

The interface timing chart is shown below.

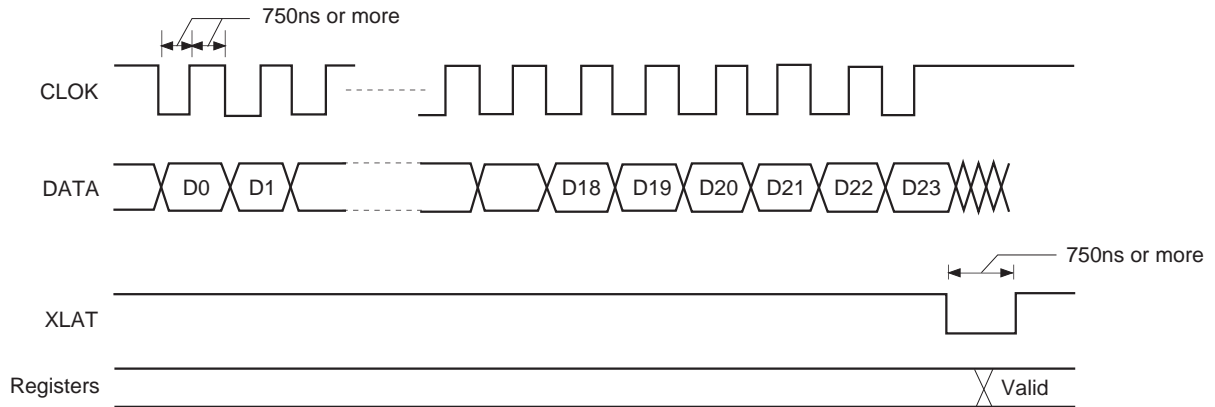

- The internal registers are initialized by a reset when XRST = 0.

§ 1-2. CPU Interface Command Table

Total bit length for each register

Register	Total bit length
0 to 2	8 bits
3	8 to 24 bits
4 to 6	16 bits
7	20 bits
8	28 bits
9	28 bits
A	28 bits
B	24 bits
C	28 bits
D	20 bits
E	20 bits

Command Table (\$0X to 1X)

Reg-ister	Command	Address D23 to D20	Data 1				Data 2				Data 3				Data 4				Data 5						
			D19	D18	D17	D16	D15	D14	D13	D12	D11	D10	D9	D8	D7	D6	D5	D4	D3	D2	D1	D0			
0	FOCUS CONTROL	0 0 0 0	1	0	—	—	—	—	—	—	—	—	—	—	—	—	—	—	—	—	—	—	—	FOCUS SERVO ON (FOCUS GAIN NORMAL)	
			1	1	—	—	—	—	—	—	—	—	—	—	—	—	—	—	—	—	—	—	—	FOCUS SERVO ON (FOCUS GAIN DOWN)	
			0	—	0	—	—	—	—	—	—	—	—	—	—	—	—	—	—	—	—	—	—	FOCUS SERVO OFF, 0V OUT	
			0	—	1	—	—	—	—	—	—	—	—	—	—	—	—	—	—	—	—	—	—	FOCUS SERVO OFF, FOCUS SEARCH VOLTAGE OUT	
			0	—	1	0	—	—	—	—	—	—	—	—	—	—	—	—	—	—	—	—	—	FOCUS SEARCH VOLTAGE DOWN	
			0	—	1	1	—	—	—	—	—	—	—	—	—	—	—	—	—	—	—	—	—	FOCUS SEACH VOLTAGE UP	
			1	0	—	—	—	—	—	—	—	—	—	—	—	—	—	—	—	—	—	—	—	ANTI SHOCK ON	
			0	—	—	—	—	—	—	—	—	—	—	—	—	—	—	—	—	—	—	—	—	ANTI SHOCK OFF	
1	TRACKING CONTROL	0 0 0 1	—	1	—	—	—	—	—	—	—	—	—	—	—	—	—	—	—	—	—	—	BRAKE ON		
			—	0	—	—	—	—	—	—	—	—	—	—	—	—	—	—	—	—	—	—	—	BRAKE OFF	
			—	—	0	—	—	—	—	—	—	—	—	—	—	—	—	—	—	—	—	—	—	TRACKING GAIN NORMAL	
			—	—	1	—	—	—	—	—	—	—	—	—	—	—	—	—	—	—	—	—	—	TRACKING GAIN UP	
			—	—	—	1	—	—	—	—	—	—	—	—	—	—	—	—	—	—	—	—	—	TRACKING GAIN UP FILTER SELECT 1	
			—	—	—	—	0	—	—	—	—	—	—	—	—	—	—	—	—	—	—	—	—	TRACKING GAIN UP FILTER SELECT 2	
			—	—	—	—	—	—	—	—	—	—	—	—	—	—	—	—	—	—	—	—	—	—	—
			—	—	—	—	—	—	—	—	—	—	—	—	—	—	—	—	—	—	—	—	—	—	—

—: Don't care

**Command Table (\$2X to 3X)**

Reg- ister	Command	Address D23 to D20	Data 1					Data 2					Data 3					Data 4					Data 5								
			D19	D18	D17	D16	D15	D14	D13	D12	D11	D10	D9	D8	D7	D6	D5	D4	D3	D2	D1	D0									
2	TRACKING MODE	0 0 1 0	0	0	—	—	—	—	—	—	—	—	—	—	—	—	—	—	—	—	—	—	—	—	—	—	—	—	TRACKING SERVO OFF		
			0	1	—	—	—	—	—	—	—	—	—	—	—	—	—	—	—	—	—	—	—	—	—	—	—	—	—	TRACKING SERVO ON	
			1	0	—	—	—	—	—	—	—	—	—	—	—	—	—	—	—	—	—	—	—	—	—	—	—	—	—	FORWARD TRACK JUMP	
			1	1	—	—	—	—	—	—	—	—	—	—	—	—	—	—	—	—	—	—	—	—	—	—	—	—	—	—	REVERSE TRACK JUMP
			—	—	0	0	—	—	—	—	—	—	—	—	—	—	—	—	—	—	—	—	—	—	—	—	—	—	—	—	SLED SERVO OFF
			—	—	—	0	1	—	—	—	—	—	—	—	—	—	—	—	—	—	—	—	—	—	—	—	—	—	—	—	SLED SERVO ON
			—	—	—	—	1	0	—	—	—	—	—	—	—	—	—	—	—	—	—	—	—	—	—	—	—	—	—	—	FORWARD SLED MOVE
			—	—	—	—	1	1	—	—	—	—	—	—	—	—	—	—	—	—	—	—	—	—	—	—	—	—	—	—	REVERSE SLED MOVE
3	SELECT	0 0 1 1	0	0	0	0	—	—	—	—	—	—	—	—	—	—	—	—	—	—	—	—	—	—	—	—	—	—	SLED KICK LEVEL (±1 × basic value) (Default)		
			0	0	0	1	—	—	—	—	—	—	—	—	—	—	—	—	—	—	—	—	—	—	—	—	—	—	—	SLED KICK LEVEL (±2 × basic value)	
			0	0	1	0	—	—	—	—	—	—	—	—	—	—	—	—	—	—	—	—	—	—	—	—	—	—	—	SLED KICK LEVEL (±3 × basic value)	
			0	0	1	1	—	—	—	—	—	—	—	—	—	—	—	—	—	—	—	—	—	—	—	—	—	—	—	SLED KICK LEVEL (±4 × basic value)	
			—	—	—	—	—	—	—	—	—	—	—	—	—	—	—	—	—	—	—	—	—	—	—	—	—	—	—	—	
			—	—	—	—	—	—	—	—	—	—	—	—	—	—	—	—	—	—	—	—	—	—	—	—	—	—	—	—	
			—	—	—	—	—	—	—	—	—	—	—	—	—	—	—	—	—	—	—	—	—	—	—	—	—	—	—	—	
			—	—	—	—	—	—	—	—	—	—	—	—	—	—	—	—	—	—	—	—	—	—	—	—	—	—	—	—	

—: Don't care

Command Table (\$340X)

Reg-ister	Command	Address 1		Address 2		Address 3		Address 4			Data 1				Data 2													
		D23 to D20		D19 to D16		D15 to D12		D11	D10	D9	D8	D7	D6	D5	D4	D3	D2	D1	D0									
3	SELECT	0011		0100	0000		0	0	0	0	0	KD7	KD6	KD5	KD4	KD3	KD2	KD1	KD0	KRAM DATA (K00) SLED INPUT GAIN								
							0	0	0	1	0	0	0	0	0	0	0	0	0	0	0	0	0	0	KRAM DATA (K01) SLED LOW BOOST FILTER A-H			
							0	0	1	0	0	0	0	0	1	0	0	0	0	0	0	0	0	0	0	0	KRAM DATA (K02) SLED LOW BOOST FILTER A-L	
							0	0	1	1	0	0	0	0	1	1	0	0	0	0	0	0	0	0	0	0	KRAM DATA (K03) SLED LOW BOOST FILTER B-H	
							0	1	0	0	0	0	0	1	0	0	0	0	0	0	0	0	0	0	0	0	KRAM DATA (K04) SLED LOW BOOST FILTER B-L	
							0	1	0	1	0	0	0	1	0	1	0	0	0	0	0	0	0	0	0	0	KRAM DATA (K05) SLED OUTPUT GAIN	
							0	1	1	0	0	0	0	1	1	0	0	0	0	0	0	0	0	0	0	0	KRAM DATA (K06) FOCUS INPUT GAIN	
							0	1	1	1	0	0	0	0	1	1	1	0	0	0	0	0	0	0	0	0	0	KRAM DATA (K07) SLED AUTO GAIN
							1	0	0	0	0	0	0	1	0	0	0	0	0	0	0	0	0	0	0	0	0	KRAM DATA (K08) FOCUS HIGH CUT FILTER A
							1	0	0	1	0	0	0	1	0	0	1	0	0	0	0	0	0	0	0	0	0	KRAM DATA (K09) FOCUS HIGH CUT FILTER B
							1	0	1	0	0	0	0	1	0	1	0	0	0	0	0	0	0	0	0	0	0	KRAM DATA (K0A) FOCUS LOW BOOST FILTER A-H
							1	0	1	1	0	0	0	1	0	1	1	0	0	0	0	0	0	0	0	0	0	KRAM DATA (K0B) FOCUS LOW BOOST FILTER A-L
							1	1	0	0	0	0	0	1	1	0	0	0	0	0	0	0	0	0	0	0	0	KRAM DATA (K0C) FOCUS LOW BOOST FILTER B-H
							1	1	1	0	1	0	0	1	1	0	1	0	0	0	0	0	0	0	0	0	0	KRAM DATA (K0D) FOCUS LOW BOOST FILTER B-L
							1	1	1	1	0	0	0	1	1	1	0	0	0	0	0	0	0	0	0	0	0	KRAM DATA (K0E) FOCUS PHASE COMPENSATE FILTER A
							1	1	1	1	1	0	0	1	1	1	1	0	0	0	0	0	0	0	0	0	0	KRAM DATA (K0F) FOCUS DEFECT HOLD GAIN

Command Table (\$341X)

Reg-ister	Command	Address 1			Address 2			Address 3			Address 4			Data 1				Data 2			
		D23 to D20	D19 to D16	D15 to D12	D11	D10	D9	D8	D7	D6	D5	D4	D3	D2	D1	D0	D3	D2	D1	D0	
3	SELECT	0 0 1 1	0 1 0 0	0 0 0 1	0 1 0 0	0 1 0 0	0 1 0 0	KD7	KD6	KD5	KD4	KD3	KD2	KD1	KD0	KRAM DATA (K10) FOCUS PHASE COMPENSATE FILTER B					
								KD7	KD6	KD5	KD4	KD3	KD2	KD1	KD0	KRAM DATA (K11) FOCUS OUTPUT GAIN					
								KD7	KD6	KD5	KD4	KD3	KD2	KD1	KD0	KRAM DATA (K12) ANTI SHOCK INPUT GAIN					
								KD7	KD6	KD5	KD4	KD3	KD2	KD1	KD0	KRAM DATA (K13) FOCUS AUTO GAIN					
								KD7	KD6	KD5	KD4	KD3	KD2	KD1	KD0	KRAM DATA (K14) HPTZC / AUTO GAIN HIGH PASS FILTER A					
								KD7	KD6	KD5	KD4	KD3	KD2	KD1	KD0	KRAM DATA (K15) HPTZC / AUTO GAIN HIGH PASS FILTER B					
								KD7	KD6	KD5	KD4	KD3	KD2	KD1	KD0	KRAM DATA (K16) ANTI SHOCK HIGH PASS FILTER A					
								KD7	KD6	KD5	KD4	KD3	KD2	KD1	KD0	KRAM DATA (K17) HPTZC / AUTO GAIN LOW PASS FILTER B					
								KD7	KD6	KD5	KD4	KD3	KD2	KD1	KD0	KRAM DATA (K18) FIX					
								KD7	KD6	KD5	KD4	KD3	KD2	KD1	KD0	KRAM DATA (K19) TRACKING INPUT GAIN					
								KD7	KD6	KD5	KD4	KD3	KD2	KD1	KD0	KRAM DATA (K1A) TRACKING HIGH CUT FILTER A					
								KD7	KD6	KD5	KD4	KD3	KD2	KD1	KD0	KRAM DATA (K1B) TRACKING HIGH CUT FILTER B					
								KD7	KD6	KD5	KD4	KD3	KD2	KD1	KD0	KRAM DATA (K1C) TRACKING LOW BOOST FILTER A-H					
								KD7	KD6	KD5	KD4	KD3	KD2	KD1	KD0	KRAM DATA (K1D) TRACKING LOW BOOST FILTER A-L					
								KD7	KD6	KD5	KD4	KD3	KD2	KD1	KD0	KRAM DATA (K1E) TRACKING LOW BOOST FILTER B-H					
								KD7	KD6	KD5	KD4	KD3	KD2	KD1	KD0	KRAM DATA (K1F) TRACKING LOW BOOST FILTER B-L					



Command Table (\$342X)

Reg-ister	Command	Address 1			Address 2			Address 3			Address 4			Data 1				Data 2														
		D23 to D20	D19 to D16	D15 to D12	D11	D10	D9	D8	D7	D6	D5	D4	D3	D2	D1	D0	KD7	KD6	KD5	KD4	KD3		KD2	KD1	KD0							
3	SELECT	0 0 1 1	0 1 0 0	0 0 1 0	0	0	0	0	KD7	KD6	KD5	KD4	KD3	KD2	KD1	KD0	KRAM DATA (K20)								TRACKING PHASE COMPENSATE FILTER A							
					0	0	0	1	KD7	KD6	KD5	KD4	KD3	KD2	KD1	KD0	KRAM DATA (K21)										TRACKING PHASE COMPENSATE FILTER B					
					0	0	1	0	KD7	KD6	KD5	KD4	KD3	KD2	KD1	KD0	KRAM DATA (K22)											TRACKING OUTPUT GAIN				
					0	0	1	1	KD7	KD6	KD5	KD4	KD3	KD2	KD1	KD0	KRAM DATA (K23)												TRACKING AUTO GAIN			
					0	1	0	0	KD7	KD6	KD5	KD4	KD3	KD2	KD1	KD0	KRAM DATA (K24)												FOCUS GAIN DOWN HIGH CUT FILTER A			
					0	1	0	1	KD7	KD6	KD5	KD4	KD3	KD2	KD1	KD0	KRAM DATA (K25)													FOCUS GAIN DOWN HIGH CUT FILTER B		
					0	1	1	0	KD7	KD6	KD5	KD4	KD3	KD2	KD1	KD0	KRAM DATA (K26)													FOCUS GAIN DOWN LOW BOOST FILTER A-H		
					0	1	1	1	KD7	KD6	KD5	KD4	KD3	KD2	KD1	KD0	KRAM DATA (K27)														FOCUS GAIN DOWN LOW BOOST FILTER A-L	
					1	0	0	0	KD7	KD6	KD5	KD4	KD3	KD2	KD1	KD0	KRAM DATA (K28)														FOCUS GAIN DOWN LOW BOOST FILTER B-H	
					1	0	0	1	KD7	KD6	KD5	KD4	KD3	KD2	KD1	KD0	KRAM DATA (K29)															FOCUS GAIN DOWN LOW BOOST FILTER B-L
					1	0	1	0	KD7	KD6	KD5	KD4	KD3	KD2	KD1	KD0	KRAM DATA (K2A)														FOCUS GAIN DOWN PHASE COMPENSATE FILTER A	
					1	0	1	1	KD7	KD6	KD5	KD4	KD3	KD2	KD1	KD0	KRAM DATA (K2B)														FOCUS GAIN DOWN DEFECT HOLD GAIN	
					1	1	0	0	KD7	KD6	KD5	KD4	KD3	KD2	KD1	KD0	KRAM DATA (K2C)														FOCUS GAIN DOWN PHASE COMPENSATE FILTER B	
					1	1	0	1	KD7	KD6	KD5	KD4	KD3	KD2	KD1	KD0	KRAM DATA (K2D)														FOCUS GAIN DOWN OUTPUT GAIN	
					1	1	1	0	KD7	KD6	KD5	KD4	KD3	KD2	KD1	KD0	KRAM DATA (K2E)														NOT USED	
					1	1	1	1	KD7	KD6	KD5	KD4	KD3	KD2	KD1	KD0	KRAM DATA (K2F)														NOT USED	

Command Table (\$343X)

Reg-ister	Command	Address 1	Address 2	Address 3	Address 4			Data 1							Data 2				
		D23 to D20	D19 to D16	D15 to D12	D11	D10	D9	D8	D7	D6	D5	D4	D3	D2	D1	D0			
3	SELECT	0 0 1 1	0 1 0 0	0 0 1 1	0	0	0	0	KD7	KD6	KD5	KD4	KD3	KD2	KD1	KD0	KRAM DATA (K30) SLED INPUT GAIN (when TGup2 is accessed with SFsk = 1)		
					0	0	1	0	KD7	KD6	KD5	KD4	KD3	KD2	KD1	KD0	KRAM DATA (K31) ANTI SHOCK LOW PASS FILTER B		
					0	0	1	0	KD7	KD6	KD5	KD4	KD3	KD2	KD1	KD0	KRAM DATA (K32) NOT USED		
					0	0	1	1	KD7	KD6	KD5	KD4	KD3	KD2	KD1	KD0	KRAM DATA (K33) ANTI SHOCK HIGH PASS FILTER B-H		
					0	1	0	0	KD7	KD6	KD5	KD4	KD3	KD2	KD1	KD0	KRAM DATA (K34) ANTI SHOCK HIGH PASS FILTER B-L		
					0	1	0	1	KD7	KD6	KD5	KD4	KD3	KD2	KD1	KD0	KRAM DATA (K35) ANTI SHOCK FILTER COMPARETE GAIN		
					0	1	1	0	KD7	KD6	KD5	KD4	KD3	KD2	KD1	KD0	KRAM DATA (K36) TRACKING GAIN UP2 HIGH CUT FILTER A		
					0	1	1	1	KD7	KD6	KD5	KD4	KD3	KD2	KD1	KD0	KRAM DATA (K37) TRACKING GAIN UP2 HIGH CUT FILTER B		
					1	0	0	0	KD7	KD6	KD5	KD4	KD3	KD2	KD1	KD0	KRAM DATA (K38) TRACKING GAIN UP2 LOW BOOST FILTER A-H		
					1	0	0	1	KD7	KD6	KD5	KD4	KD3	KD2	KD1	KD0	KRAM DATA (K39) TRACKING GAIN UP2 LOW BOOST FILTER A-L		
					1	0	1	0	KD7	KD6	KD5	KD4	KD3	KD2	KD1	KD0	KRAM DATA (K3A) TRACKING GAIN UP2 LOW BOOST FILTER B-H		
					1	0	1	1	KD7	KD6	KD5	KD4	KD3	KD2	KD1	KD0	KRAM DATA (K3B) TRACKING GAIN UP2 LOW BOOST FILTER B-L		
					1	1	0	0	KD7	KD6	KD5	KD4	KD3	KD2	KD1	KD0	KRAM DATA (K3C) TRACKING GAIN UP PHASE COMPENSATE FILTER A		
					1	1	0	1	KD7	KD6	KD5	KD4	KD3	KD2	KD1	KD0	KRAM DATA (K3D) TRACKING GAIN UP PHASE COMPENSATE FILTER B		
					1	1	1	0	KD7	KD6	KD5	KD4	KD3	KD2	KD1	KD0	KRAM DATA (K3E) TRACKING GAIN UP OUTPUT GAIN		
					1	1	1	1	KD7	KD6	KD5	KD4	KD3	KD2	KD1	KD0	KRAM DATA (K3F) NOT USED		





Command Table (\$35X to 3FX)

Reg- ister	Command	Address							Data 1				Data 2				Data 3							Data 4							
		D23 to D20	D19	D18	D17	D16	D15	D14	D13	D12	D11	D10	D9	D8	D7	D6	D5	D4	D3	D2	D1	D0									
3	SELECT	0	1	0	1	1	0	1	0	1	FT1	FT0	FS5	FS4	FS3	FS2	FS1	FS0	FTZ	FG6	FG5	FG4	FG3	FG2	FG1	FG0	FCS search, AGF				
		0	1	1	1	0	0	0	0	0	0	0	0	0	0	0	0	0	0	0	0	0	0	0	0	0	0	TRK jump, AGT			
		0	1	1	1	1	1	0	0	0	0	0	0	0	0	0	0	0	0	0	0	0	0	0	0	0	0	0	FZC, AGC, SLD move		
		1	0	0	0	0	0	0	0	0	0	0	0	0	0	0	0	0	0	0	0	0	0	0	0	0	0	0	DC measure, cancel		
		1	0	0	0	1	0	0	0	0	0	0	0	0	0	0	0	0	0	0	0	0	0	0	0	0	0	0	Serial data read out		
		1	0	0	1	0	0	0	1	0	0	0	0	0	0	0	0	0	0	0	0	0	0	0	0	0	0	0	0	FCS Bias, Gain, Surf jump/brake	
		1	0	0	1	1	0	0	1	0	0	0	0	0	0	0	0	0	0	0	0	0	0	0	0	0	0	0	0	Mirr, DFCT, FOK	
		1	1	0	0	0	0	0	0	0	0	0	0	0	0	0	0	0	0	0	0	0	0	0	0	0	0	0	0	0	TZC, Cout, Bottom, Mirr
		1	1	0	0	1	0	0	0	0	0	0	0	0	0	0	0	0	0	0	0	0	0	0	0	0	0	0	0	0	SLD filter
		1	1	1	1	0	0	0	0	0	0	0	0	0	0	0	0	0	0	0	0	0	0	0	0	0	0	0	0	0	Filter
		1	1	1	1	1	1	1	1	1	0	0	0	0	0	0	0	0	0	0	0	0	0	0	0	0	0	0	0	0	0

Command Table (\$4X to EX)

Reg-ister	Command	Address					Data 1					Data 2					Data 3					Data 4								
		D27	D26	D25	D24	D23	D22	D21	D20	D19	D18	D17	D16	D15	D14	D13	D12	D11	D10	D9	D8									
4	Auto sequence	0	1	0	0	AS3	AS2	AS1	AS0	MT3	MT2	MT1	MT0	LSSL	0	0	—	—	—	—	—	—	—	—	—	—	—	—		
5	Blind (A, E), Brake (B), Overflow (C, G)	0	1	0	1	TR3	TR2	TR1	TR0	0	0	0	0	0	0	0	—	—	—	—	—	—	—	—	—	—	—	—		
6	Sled KICK, BRAKE (D), KICK (F)	0	1	1	0	SD3	SD2	SD1	SD0	KF3	KF2	KF1	KF0	0	0	0	—	—	—	—	—	—	—	—	—	—	—	—		
7	Auto sequence (N) track jump count setting	0	1	1	1	32768	16384	8192	4096	2048	1024	512	256	128	64	32	16	8	4	2	1	—	—	—	—	—	—	—		
8	MODE specification	1	0	0	0	CD- ROM	DOUT Mute	DOUT Mute-F	WSEL	VCO SEL1	ASHS SOCT0	SOCT0	VCO SEL2	KSL3	KSL2	KSL1	KSL0	0	0	0	—	—	—	—	—	—	—	XVCO2 THRU	0	
9	Function specification	1	0	0	1	1	DSPB ON/OFF	ASEQ ON/OFF	1	BitIGL MAIN	BitIGL SUB	FLFC	1	0	0	0	0	1	0	0	0	0	0	0	0	0	0	0	1	
A	Audio CTRL	1	0	1	0	VARI ON	VARI USE	Mute	ATT	PCT1	PCT2	0	SOC2	0	0	0	0	1	0	0	0	0	0	0	0	0	0	0	0	
B	Traverse monitor counter setting	1	0	1	1	32768	16384	8192	4096	2048	1024	512	256	128	64	32	16	8	4	2	1	—	—	—	—	—	—	—	—	
C	Spindle servo coefficient setting	1	1	0	0	Gain MDP1	Gain MDP0	Gain MDS1	Gain MDS0	Gain DCLV1	Gain DCLV0	PCC1	PCC0	SFP3	SFP2	SFP1	SFP0	SRP3	SRP2	SRP1	SRP0	—	—	—	—	—	—	—	—	—
D	CLV CTRL	1	1	0	1	0	TB	TP	CLVS Gain	VP7	VP6	VP5	VP4	VP3	VP2	VP1	VP0	VP CTL1	VP CTL0	0	0	0	0	0	0	0	0	0		
E	SPD mode	1	1	1	0	CM3	CM2	CM1	CM0	EPWM	SPDC	ICAP	SFSL	VC2C	HIFC	LPWR	VPON	Gain CAV1	Gain CAV0	0	0	0	0	0	0	0	0	INV VPCO		

—: Don't care







Command Preset Table (\$35X to 3FX)

Reg-ister	Command	Address								Data 1				Data 2				Data 3				Data 4												
		D23 to D20	D19	D18	D17	D16	D15	D14	D13	D12	D11	D10	D9	D8	D7	D6	D5	D4	D3	D2	D1	D0												
3	SELECT	0 0 1 1 1 1 1 1								0	1	0	1	0	0	0	0	1	0	0	0	0	0	0	0	0	0	0	0	1	1	0	1	FCS search, AGF
		0 1 1 1 1 1 1 1								0	0	0	0	1	1	0	0	0	0	0	0	0	0	0	0	0	0	0	0	1	1	0	0	TRK jump, AGT
		0 1 1 1 1 1 1 1								0	1	0	1	0	0	0	1	0	0	0	0	0	0	0	0	0	0	0	0	1	1	0	0	FZC, AGC, SLD move
		1 0 0 0 0 0 0 0								1	0	0	0	0	0	0	0	0	0	0	0	0	0	0	0	0	0	0	0	0	0	0	0	DC measure, cancel
		1 0 0 0 0 0 0 0								1	0	0	0	0	0	0	0	0	0	0	0	0	0	0	0	0	0	0	0	0	0	0	0	Serial data read out
		1 0 1 0 0 1 0 1								1	0	0	0	0	0	0	0	0	0	0	0	0	0	0	0	0	0	0	0	0	0	0	0	FCS Bias, Gain, Surf jump/brake
		1 0 1 1 1 1 1 1								1	0	1	1	1	1	1	0	0	0	0	0	0	0	0	0	1	0	0	0	0	0	0	0	Mirr, DFCT, FOK
		1 1 1 0 0 0 0 0								1	1	0	0	0	0	0	0	0	0	0	0	0	0	0	0	0	0	0	0	0	0	0	0	TZC, Cout, Bottom, Mirr
		1 1 1 0 0 1 0 1								1	1	0	1	0	0	0	0	0	0	0	0	0	0	0	0	0	0	0	0	0	0	0	0	SLD filter
		1 1 1 1 1 0 0 0								1	1	1	1	0	0	0	0	0	0	0	0	0	0	0	0	0	0	0	0	0	0	0	0	Filter
1 1 1 1 1 1 1 1								1	1	1	1	1	1	1	0	0	0	0	0	0	0	0	0	0	0	0	0	0	0	0	0	Clock, others		

Command Preset Table (\$4X to EX)

Reg-ister	Command	Address					Data 1				Data 2				Data 3				Data 4			
		D27	D26	D25	D24	D23	D22	D21	D20	D19	D18	D17	D16	D15	D14	D13	D12	D11	D10	D9	D8	
4	Auto sequence	0	1	0	0	0	0	0	0	0	0	0	0	0	0	0	0	0	0	0	0	
5	Blind (A, E), Brake (B), Overflow (C, G)	0	1	0	1	0	1	0	1	0	0	0	0	0	0	0	0	0	0	0	0	
6	Sled KICK, BRAKE (D), KICK (F)	0	1	1	0	0	1	1	0	0	0	0	0	0	0	0	0	0	0	0	0	
7	Auto sequence (N) track jump count setting	0	1	1	1	0	0	0	0	0	0	1	0	0	0	0	0	0	0	0	0	
8	MODE specification	1	0	0	0	0	0	0	0	0	0	0	0	0	0	0	0	0	0	0	0	
9	Function specification	1	0	0	1	1	0	0	1	0	0	1	0	0	0	0	1	0	0	0	1	
A	Audio CTRL	1	0	1	0	0	0	1	1	0	0	0	0	0	0	0	0	1	0	0	0	
B	Traverse monitor counter setting	1	0	1	1	0	0	0	0	0	0	1	0	0	0	0	0	0	0	0	0	
C	Spindle servo coefficient setting	1	1	0	0	0	0	0	0	0	0	0	1	1	0	0	0	0	1	1	1	
D	CLV CTRL	1	1	0	1	0	0	0	0	0	0	0	0	0	0	0	0	0	0	0	0	
E	SPD mode	1	1	1	0	0	0	0	0	0	0	0	0	0	0	0	0	0	0	0	0	

Reg-ister	Command	Address	Data 1				Data 2				Data 3				Data 4				Data 5				Data 6			
			D27	D26	D25	D24	D23	D22	D21	D20	D19	D18	D17	D16	D15	D14	D13	D12	D11	D10	D9	D8				
8	MODE specification	1 0 0 0																								
9	Function specification	1 0 0 1																								
A	Audio CTRL	1 0 1 0																								
B	Traverse monitor counter setting	1 0 1 1																								
C	Spindle servo coefficient setting	1 1 0 0																								

—: Don't care

&lt;Coefficient ROM Preset Values Table (1)&gt;

ADDRESS	DATA	CONTENTS
K00	E0	SLED INPUT GAIN
K01	81	SLED LOW BOOST FILTER A-H
K02	23	SLED LOW BOOST FILTER A-L
K03	7F	SLED LOW BOOST FILTER B-H
K04	6A	SLED LOW BOOST FILTER B-L
K05	10	SLED OUTPUT GAIN
K06	14	FOCUS INPUT GAIN
K07	30	SLED AUTO GAIN
K08	7F	FOCUS HIGH CUT FILTER A
K09	46	FOCUS HIGH CUT FILTER B
K0A	81	FOCUS LOW BOOST FILTER A-H
K0B	1C	FOCUS LOW BOOST FILTER A-L
K0C	7F	FOCUS LOW BOOST FILTER B-H
K0D	58	FOCUS LOW BOOST FILTER B-L
K0E	82	FOCUS PHASE COMPENSATE FILTER A
K0F	7F	FOCUS DEFECT HOLD GAIN
K10	4E	FOCUS PHASE COMPENSATE FILTER B
K11	32	FOCUS OUTPUT GAIN
K12	20	ANTI SHOCK INPUT GAIN
K13	30	FOCUS AUTO GAIN
K14	80	HPTZC / Auto Gain HIGH PASS FILTER A
K15	77	HPTZC / Auto Gain HIGH PASS FILTER B
K16	80	ANTI SHOCK HIGH PASS FILTER A
K17	77	HPTZC / Auto Gain LOW PASS FILTER B
K18	00	Fix*
K19	F1	TRACKING INPUT GAIN
K1A	7F	TRACKING HIGH CUT FILTER A
K1B	3B	TRACKING HIGH CUT FILTER B
K1C	81	TRACKING LOW BOOST FILTER A-H
K1D	44	TRACKING LOW BOOST FILTER A-L
K1E	7F	TRACKING LOW BOOST FILTER B-H
K1F	5E	TRACKING LOW BOOST FILTER B-L
K20	82	TRACKING PHASE COMPENSATE FILTER A
K21	44	TRACKING PHASE COMPENSATE FILTER B
K22	18	TRACKING OUTPUT GAIN
K23	30	TRACKING AUTO GAIN
K24	7F	FOCUS GAIN DOWN HIGH CUT FILTER A
K25	46	FOCUS GAIN DOWN HIGH CUT FILTER B
K26	81	FOCUS GAIN DOWN LOW BOOST FILTER A-H
K27	3A	FOCUS GAIN DOWN LOW BOOST FILTER A-L
K28	7F	FOCUS GAIN DOWN LOW BOOST FILTER B-H
K29	66	FOCUS GAIN DOWN LOW BOOST FILTER B-L
K2A	82	FOCUS GAIN DOWN PHASE COMPENSATE FILTER A
K2B	44	FOCUS GAIN DOWN DEFECT HOLD GAIN
K2C	4E	FOCUS GAIN DOWN PHASE COMPENSATE FILTER B
K2D	1B	FOCUS GAIN DOWN OUTPUT GAIN
K2E	00	NOT USED
K2F	00	NOT USED

\* Fix indicates that normal preset values should be used.

&lt;Coefficient ROM Preset Values Table (2)&gt;

ADDRESS	DATA	CONTENTS
K30	80	SLED INPUT GAIN (Only when TRK Gain Up2 is accessed with SFSK = 1.)
K31	66	ANTI SHOCK LOW PASS FILTER B
K32	00	NOT USED
K33	7F	ANTI SHOCK HIGH PASS FILTER B-H
K34	6E	ANTI SHOCK HIGH PASS FILTER B-L
K35	20	ANTI SHOCK FILTER COMPARATE GAIN
K36	7F	TRACKING GAIN UP2 HIGH CUT FILTER A
K37	3B	TRACKING GAIN UP2 HIGH CUT FILTER B
K38	80	TRACKING GAIN UP2 LOW BOOST FILTER A-H
K39	44	TRACKING GAIN UP2 LOW BOOST FILTER A-L
K3A	7F	TRACKING GAIN UP2 LOW BOOST FILTER B-H
K3B	77	TRACKING GAIN UP2 LOW BOOST FILTER B-L
K3C	86	TRACKING GAIN UP PHASE COMPENSATE FILTER A
K3D	0D	TRACKING GAIN UP PHASE COMPENSATE FILTER B
K3E	57	TRACKING GAIN UP OUTPUT GAIN
K3F	00	NOT USED
K40	04	TRACKING HOLD FILTER INPUT GAIN
K41	7F	TRACKING HOLD FILTER A-H
K42	7F	TRACKING HOLD FILTER A-L
K43	79	TRACKING HOLD FILTER B-H
K44	17	TRACKING HOLD FILTER B-L
K45	6D	TRACKING HOLD FILTER OUTPUT GAIN
K46	00	TRACKING HOLD FILTER INPUT GAIN (Only when TRK Gain Up2 is accessed with THSK = 1.)
K47	00	NOT USED
K48	02	FOCUS HOLD FILTER INPUT GAIN
K49	7F	FOCUS HOLD FILTER A-H
K4A	7F	FOCUS HOLD FILTER A-L
K4B	79	FOCUS HOLD FILTER B-H
K4C	17	FOCUS HOLD FILTER B-L
K4D	54	FOCUS HOLD FILTER OUTPUT GAIN
K4E	00	NOT USED
K4F	00	NOT USED

## § 1-4. Description of SENS Signals

## SENS output

Microcomputer serial register (latching not required)	ASEQ = 0	ASEQ = 1	Output data length
\$0X	Z	FZC	—
\$1X	Z	AS	—
\$2X	Z	TZC	—
\$30 to 37	Z	SSTP	—
\$38	Z	AGOK*	—
\$38	Z	XAVEBSY*	—
\$3904	Z	TE Avg Reg.	9 bits
\$3908	Z	FE Avg Reg.	9 bits
\$390C	Z	VC Avg Reg.	9 bits
\$391C	Z	TRVSC Reg.	9 bits
\$391D	Z	FB Reg.	9 bits
\$391F	Z	RFDC Avg Reg.	8 bits
\$3A	Z	FBIAS Count STOP	—
\$3B to 3F	Z	SSTP	—
\$4X	Z	XBUSY	—
\$5X	Z	FOK	—
\$6X	Z	0	—
\$AX	GFS	GFS	—
\$BX	COMP	COMP	—
\$CX	COUT	COUT	—
\$EX	$\overline{\text{OV64}}$	$\overline{\text{OV64}}$	—
\$7X, 8X, 9X, DX, FX	Z	0	—

\* \$38 outputs AGOK during AGT and AGF command settings, and XAVEBSY during AVRG measurement. SSTP is output in all other cases.

**Description of SENS Signals**

SENS output	
Z	The SENS pin is high impedance.
XBUSY	Low while the auto sequencer is in operation, high when operation terminates.
FOK	Outputs the same signal as the FOK pin. High for "focus OK".
GFS	High when the regenerated frame sync is obtained with the correct timing.
COMP	Counts the number of tracks set with Reg.B. High when Reg.B is latched, low when the initial Reg.B number is counted through COUT.
COUT	Counts the number of tracks set with Reg.B. High when Reg.B is latched, toggles each time the Reg.B number is counted through COUT. While \$44 and \$45 are being executed, toggles with each COUT 8-count instead of the Reg.B number.
$\overline{\text{OV64}}$	Low when the EFM signal is lengthened by 64 channel clock pulses or more after passing through the sync detection filter.

The meaning of the data for each address is explained below.

**\$4X commands**

Register name	Data 1				Data 2				Data 3			
4	Command				MAX timer value				Timer range			
	AS3	AS2	AS1	AS0	MT3	MT2	MT1	MT0	LSSL	0	0	0

Command	AS3	AS2	AS1	AS0
Cancel	0	0	0	0
Fine Search	0	1	0	RXF
Focus-On	0	1	1	1
1 Track Jump	1	0	0	RXF
10 Track Jump	1	0	1	RXF
2N Track Jump	1	1	0	RXF
M Track Move	1	1	1	RXF

RXF = 0 Forward

RXF = 1 Reverse

- When the Focus-on command (\$47) is canceled, \$02 is sent and the auto sequence is interrupted.
- When the Track jump commands (\$44 to \$45, \$48 to \$4D) are canceled, \$25 is sent and the auto sequence is interrupted.

MAX timer value				Timer range			
MT3	MT2	MT1	MT0	LSSL	0	0	0
23.2ms	11.6ms	5.8ms	2.9ms	0	0	0	0
1.49s	0.74s	0.37s	0.18s	1	0	0	0

- To disable the MAX timer, set the MAX timer value to 0.

**\$5X commands**

Timer	TR3	TR2	TR1	TR0
Blind (A, E), Overflow (C, G)	0.18ms	0.09ms	0.045ms	0.022ms
Brake (B)	0.36ms	0.18ms	0.09ms	0.045ms

**\$6X commands**

Register name	Data 1				Data 2			
6	KICK (D)				KICK (F)			
	SD3	SD2	SD1	SD0	KF3	KF2	KF1	KF0

Timer	SD3	SD2	SD1	SD0
When executing KICK (D) \$44 or \$45	23.2ms	11.6ms	5.8ms	2.9ms
When executing KICK (D) \$4C or \$4D	11.6ms	5.8ms	2.9ms	1.45ms

Timer	KF3	KF2	KF1	KF0
KICK (F)	0.72ms	0.36ms	0.18ms	0.09ms

**\$7X commands**

Auto sequencer track jump count setting

Command	Data 1				Data 2				Data 3				Data 4			
	D23	D22	D21	D20	D19	D18	D17	D16	D15	D14	D13	D12	D11	D10	D9	D8
Auto sequence track jump count setting	2 <sup>15</sup>	2 <sup>14</sup>	2 <sup>13</sup>	2 <sup>12</sup>	2 <sup>11</sup>	2 <sup>10</sup>	2 <sup>9</sup>	2 <sup>8</sup>	2 <sup>7</sup>	2 <sup>6</sup>	2 <sup>5</sup>	2 <sup>4</sup>	2 <sup>3</sup>	2 <sup>2</sup>	2 <sup>1</sup>	2 <sup>0</sup>

This command is used to set N when a 2N-track jump is executed, to set M when an M-track move is executed and to set the jump count when fine search is executed for auto sequencer.

- The maximum track count is 65,535, but note that with a 2N-track jump the maximum track jump count depends on the mechanical limitations of the optical system.
- When the track jump count is from 0 to 15, the COUT signal is counted for 2N-track jumps and M-track moves; when the count is 16 or over, the MIRR signal is counted. For fine search, the COUT signal is counted.



**\$8X commands**

Command	Data 1				Data 2			
	D23	D22	D21	D20	D19	D18	D17	D16
MODE specification	CD-ROM	DOUT Mute	DOUT Mute-F	WSEL	VCO SEL1	ASHS	SOCT0	VCO SEL2

Command bit	C2PO timing	Processing
CDROM = 1	1-3	CDROM mode; average value interpolation and pre-value hold are not performed.
CDROM = 0	1-3	Audio mode; average value interpolation and pre-value hold are performed.

Command bit	Processing
DOUT Mute = 1	When Digital Out is on (MD2 pin = 1), DOUT output is muted.
DOUT Mute = 0	When Digital Out is on, DOUT output is not muted.

Command bit	Processing
D. out Mute F = 1	When Digital Out is on (MD2 pin = 1), DA output is muted.
D. out Mute F = 0	DA output mute is not affected when Digital Out is either on or off.

MD2	Other mute conditions*	DOUT Mute	D.out Mute F	DOUT output	DA output for 48-bit slot
0	0	0	0	OFF	0dB
0	0	0	1		
0	0	1	0		
0	0	1	1		
0	1	0	0		-∞dB
0	1	0	1		
0	1	1	0		
0	1	1	1		
1	0	0	0	0dB	0dB
1	0	0	1		-∞dB
1	0	1	0	-∞dB	0dB
1	0	1	1		
1	1	0	0		-∞dB
1	1	0	1		
1	1	1	0		
1	1	1	1		

\* See mute conditions (1), (2), and (4) to (6) under \$AX commands for other mute conditions.

Command bit	Sync protection window width	Application
WSEL = 1	±26 channel clock	Anti-rolling is enhanced.
WSEL = 0	±6 channel clock	Sync window protection is enhanced.

\* In normal-speed playback, channel clock = 4.3218MHz.

Command bit	Function
ASHS = 0	The command transfer rate to DSSP block from auto sequencer is set to normal speed.
ASHS = 1	The command transfer rate to DSSP block from auto sequencer is set to half speed.

\* See "§ 4-8. Playback Speed" for settings.

Command bit		Processing
SOCT0	SOCT1	
0	—	Sub-Q is output from the SQSO pin.
1	0	Each signal is output from the SQSO pin. Input the readout clock to SQCK. (See Timing Chart 2-4.)
1	1	The error rate is output from the SQSO pin. Input the readout clock to SQCK. (See Timing Chart 2-6.)

—: Don't care

Command	Data 2				Data 3			
	D19	D18	D17	D16	D15	D14	D13	D12
MODE specification	VCO SEL1	ASHS	SOCT0	VCO SEL2	KSL3	KSL2	KSL1	KSL0

See the previous page.

Command bit	Processing
VCOSEL1 = 0	Multiplier PLL VCO1 is set to normal speed.
VCOSEL1 = 1	Multiplier PLL VCO1 is set to approximately twice the normal speed.

Command bit		Processing
KSL3	KSL2	
0	0	Output of multiplier PLL VCO1 is 1/1 frequency-divided.
0	1	Output of multiplier PLL VCO1 is 1/2 frequency-divided.
1	0	Output of multiplier PLL VCO1 is 1/4 frequency-divided.
1	1	Output of multiplier PLL VCO1 is 1/8 frequency-divided.

Command bit	Processing
VCOSEL2 = 0	Wide-band PLL VCO2 is set to normal speed.
VCOSEL2 = 1	Wide-band PLL VCO2 is set to approximately twice the normal speed.

Command bit		Processing
KSL1	KSL0	
0	0	Output of wide-band PLL VCO2 is 1/1 frequency-divided.
0	1	Output of wide-band PLL VCO2 is 1/2 frequency-divided.
1	0	Output of wide-band PLL VCO2 is 1/4 frequency-divided.
1	1	Output of wide-band PLL VCO2 is 1/8 frequency-divided.

Command	Data 4				Data 5				Data 6			
	D11	D10	D9	D8	D7	D6	D5	D4	D3	D2	D1	D0
Mode specification	0	0	VCO2 THRU	0	ERC4	SCOR SEL	SCSY	SOCT1	TXON	TXOUT	OUTL1	OUTL0

Command bit	Processing
VCO2 THRU = 0	V16M is output.
VCO2 THRU = 1	The wide-band EFM PLL clock can be input from the V16M pin.

\* These bits select the internal or external connection for the VCO2 used in CAV-W or variable pitch mode.

Command bit	Processing
ERC4 = 0	C2 error double correction is performed when DSPB = 1.
ERC4 = 1	C2 error quadruple correction is performed even when DSPB = 1.

Command bit	Processing
SCOR SEL = 0	WDCK signal is output.
SCOR SEL = 1	GRSCOR (protected SCOR) is output.

\* Used when outputting GRSCOR from the WDCK pin.

Command bit	Processing
SCSY = 0	No processing.
SCSY = 1	GRSCOR (protected SCOR) synchronization is applied again.

\* Used to resynchronize GRSCOR.

The rising edge signal of this command bit is used internally. Therefore, when resynchronizing GRSCOR, first return the setting to 0 and then set to 1.

GRSCOR achieves the crystal accuracy by removing the jitter components included in the SCOR signal. This signal is synchronized with PCMDATA.

The resynchronization conditions are when G<sub>TOP</sub> = high or when the SCSY pin = high.  
(same as when SCSY = 1 is sent by the \$8X command.)

Command bit	Processing
TXON = 0	When CD TEXT data is not demodulated, set TXON to 0.
TXON = 1	When CD TEXT data is demodulated, set TXON to 1.

\* See "\$4-10. CD TEXT Data Demodulation"

Command bit	Processing
TXOUT = 0	Various signals except for CD TEXT is output from the SQSO pin.
TXOUT = 1	CD TEXT data is output from the SQSO pin.

\* See "\$4-10. CD TEXT Data Demodulation"

Command bit	Processing
OUTL1 = 0	WFCK, XPCK C4M, WDCK and FSTO are output. V16M is output when VCO2 THRU = 0.
OUTL1 = 1	WFCK, XPCK C4M, WDCK and FSTO outputs are set to low. The V16M output is low when VCO2 THRU = 0.

Command bit	Processing
OUTL0 = 0	PCMD, BCK, LRCK and EMPH are output.
OUTL0 = 1	PCMD, BCK, LRCK and EMPH outputs are low.

**\$9X commands**

Command	Data 1				Data 2			
	D23	D22	D21	D20	D19	D18	D17	D16
Function specification	1	DSPB ON-OFF	A.SEQ ON-OFF	1	BiliGL MAIN	BiliGL SUB	FLFC	1

Command bit	Processing
DSPB = 0	Normal-speed playback, C2 error quadruple correction.
DSPB = 1	Double-speed playback, C2 error double correction. (quadruple correction when ERC4 = 1)

FLFC is normally 0.

FLFC is 1 in CAV-W mode, for any playback speed.

Command bit	BiliGL MAIN = 0	BiliGL MAIN = 1
BiliGL SUB = 0	STEREO	MAIN
BiliGL SUB = 1	SUB	Mute

Definition of bilingual capable MAIN, SUB and STEREO

The left channel input is output to the left and right channels for MAIN.

The right channel input is output to the left and right channels for SUB.

The left and right channel inputs are output to the left and right channels for STEREO.

**\$AX commands**

Command	Data 1				Data 2			
	D23	D22	D21	D20	D19	D18	D17	D16
Audio CTRL	VARI ON	VARI USE	Mute	ATT	PCT1	PCT2	0	SOC2

Command bit	Processing
VARION = 0	Variable pitch mode is turned off. (The crystal is the reference to the internal clock.)
VARION = 1	Variable pitch mode is turned on. (The VCO2 is the reference to the internal clock.)

Command bit	Processing
VARIUSE = 0	When the variable pitch mode is not used, set VARIUSE to 0 .
VARIUSE = 1	When the variable pitch mode is used, set VARIUSE to 1.

\* See "\$DX commands" for the variable range and the usage example of the variable pitch.

Command bit	Meaning
Mute = 0	Mute off if other mute conditions are not set.
Mute = 1	Mute on. Peak register reset.

Command bit	Meaning
ATT = 0	Attenuation off.
ATT = 1	-12dB

**Mute conditions**

- (1) When register A mute = 1.
- (2) When Mute pin = 1.
- (3) When register 8 D.out Mute F = 1 and the Digital Out is on (MD2 pin = 1).
- (4) When GFS stays low for over 35 ms (during normal-speed).
- (5) When register 9 BiliGL MAIN = Sub = 1.
- (6) When register A PCT1 = 1 and PCT2 = 0.

(1) to (4) perform zero-cross muting with a 1ms time limit.

Command bit		Meaning	PCM Gain	ECC error correction ability
PCT1	PCT2			
0	0	Normal mode	× 0dB	C1: double; C2: quadruple
0	1	Level meter mode	× 0dB	C1: double; C2: quadruple
1	0	Peak meter mode	Mute	C1: double; C2: double
1	1	Normal mode	× 0dB	C1: double; C2: double

**Description of level meter mode** (see Timing Chart 1-4.)

- When the LSI is set to this mode, it performs digital level meter functions.
- When the 96-bit clock is input to SQCK, 96 bits of data are output to SQSO.  
The initial 80 bits are Sub-Q data (see § 2. Subcode Interface). The last 16 bits are LSB first, which are 15-bit PCM data (absolute values) and an L/R flag.  
The L/R flag is high when the 15-bit PCM data is from the left channel and low when the data is from the right channel.
- The PCM data is reset and the L/R flag is reversed after one readout.  
Then maximum value measuring continues until the next readout.

**Description of peak meter mode** (see Timing Chart 1-5.)

- When the LSI is set to this mode, the maximum PCM data value is detected regardless of if it comes from the left or right channel.

The 96-bit clock must be input to SQCK to read out this data.

- When the 96-bit clock is input, 96 bits of data are output to SQSO and the value is set in the LSI internal register again.

In other words, the PCM maximum value detection register is not reset by the readout.

- To reset the PCM maximum value register to zero, set PCT1 = PCT2 = 0 or set the \$AX mute.
- The Sub-Q absolute time is automatically controlled in this mode.  
In other words, after the maximum value is generated, the absolute time for CRC to become OK is retained in the memory. Normal operation is conducted for the relative time.
- The final bit (L/R flag) of the 96-bit data is normally 0.
- The pre-value hold and average value interpolation data are fixed to level ( $-\infty$ ) for this mode.

Command bit	Processing
SOC2 = 0	The SENS signal is output from the SENS pin as usual.
SOC2 = 1	The SQSO pin signal is output from the SENS pin.

**SENS output switching**

- This command enables the SQSO pin signal to be output from the SENS pin.

When SOC2 = 0, SENS output is performed as usual.

When SOC2 = 1, the SQSO pin signal is output from the SENS pin.

At this time, the readout clock is input to the SCLK pin.

**Note)** SOC2 should be switched when SQCK = SCLK = high.

**\$BX commands**

This command sets the traverse monitor count.

Command	Data 1				Data 2				Data 3				Data 4			
	D23	D22	D21	D20	D19	D18	D17	D16	D15	D14	D13	D12	D11	D10	D9	D8
Traverse monitor count setting	$2^{15}$	$2^{14}$	$2^{13}$	$2^{12}$	$2^{11}$	$2^{10}$	$2^9$	$2^8$	$2^7$	$2^6$	$2^5$	$2^4$	$2^3$	$2^2$	$2^1$	$2^0$

- When the set number of tracks are counted during fine search, the sled control for the traverse cycle control goes off.
- The traverse monitor count is set to monitor the traverse status from the SENS output as COMP and COUT.

This command sets the monitor output switching.

Command	Data 5			
	D7	D6	D5	D4
Traverse monitor count setting	0	0	MTSL1	MTSL0

Command bit		Output data			
MTSL1	MTSL0				
0	0	XUGF	XPCK	GFS	C2PO
0	1	MINT0	MNT1	MNT2	MNT3
1	0	RFCK	XPCK	XROF	GTOP

**\$CX commands**

Command	Data 1				Data 2			
	D23	D22	D21	D20	D19	D18	D17	D16
Spindle servo coefficient setting	Gain MDP1	Gain MDP0	Gain MDS1	Gain MDS0	Gain DCLV1	Gain DCLV0	PCC1	PCC0
CLV CTRL (\$DX)				Gain CLVS				

- CLVS mode gain setting: GCLVS

Gain MDS1	Gain MDS0	Gain CLVS	GCLVS
0	0	0	-12dB
0	0	1	-6dB
0	1	0	-6dB
0	1	1	0dB
1	0	0	0dB
1	0	1	+6dB

- CLVP mode gain setting: GMDP : GMDS

Gain MDP1	Gain MDP0	GMDP
0	0	-6dB
0	1	0dB
1	0	+6dB

Gain MDS1	Gain MDS0	GMDS
0	0	-6dB
0	1	0dB
1	0	+6dB

- DCLV overall gain setting: GDCLV

Gain DCLV1	Gain DCLV0	GDCLV
0	0	0dB
0	1	+6dB
1	0	+12dB

Command bit		Processing
PCC1	PCC0	
0	0	The VPCO signal is output.
0	1	The VPCO pin output is high impedance.
1	0	The VPCO pin output is low.
1	1	The VPCO pin output is high.

- This command controls the VPCO pin signal.

The VPCO output can be controlled with this setting.



Command	Data 3				Data 4			
	D15	D14	D13	D12	D11	D10	D9	D8
Spindle servo coefficient setting	SFP3	SFP2	SFP1	SFP0	SRP3	SRP2	SRP1	SRP0

Command bit	Processing
SFP3 to 0	Sets the frame sync forward protection times. The setting range is 1 to F (Hex).

Command bit	Processing
SRP3 to 0	Sets the frame sync backward protection times. The setting range is 1 to F (Hex).

\* See § 4-2. Frame Sync Protection regarding frame sync protection.

- The CXD2585Q can serially output the 40 bits (10 BCD codes) of error monitor data selected by EDC0 to 7 from the SQSO pin and monitor this data using a microcomputer.

The C1 and C2 error rate settings are sent one at a time by the \$C commands by setting \$8 commands SOCT0 and SOCT1 = 1. Then, the data can be read out from the SQSO pin by sending 40 SQCK pulses.

#### **\$CX commands**

Command	Data 5				Data 6			
	D7	D6	D5	D4	D3	D2	D1	D0
Spindle servo coefficient setting	EDC7	EDC6	EDC5	EDC4	EDC3	EDC2	EDC1	EDC0

**Error monitor commands**

Command bit	Processing
EDC7 = 0 EDC6	The [No C1 errors, pointer set] count is output when 0.
EDC5	The [One C1 error corrected, pointer reset] count is output when 0.
EDC4	The [No C1 errors, pointer set] count is output when 0.
EDC3	The [One C1 error corrected, pointer set] count is output when 0.
EDC2	The [Two C1 errors corrected, pointer set] count is output when 0.
EDC1	The [C1 correction impossible, pointer set] count is output when 0.
EDC0	7350 frame count cycle mode*1 when 1. 73500 frame count cycle mode*2 when 0.
EDC7 = 1 EDC6	The [No C2 errors, pointer reset] count is output when 0.
EDC5	The [One C2 error corrected, pointer reset] count is output when 0.
EDC4	The [Two C2 errors corrected, pointer reset] count is output when 0.
EDC3	The [Three C2 errors corrected, pointer reset] count is output when 0.
EDC2	The [Four C2 errors corrected, pointer reset] count is output when 0.
EDC1	The [C2 correction impossible, pointer copy] count is output when 0.
EDC0	The [C2 correction impossible, pointer set] count is output when 0.

\*1 The number selected by C1 (EDC1 to 6) and C2 (EDC0 to 6) is added to C1 and C2 and output every 7350 frames.

\*2 The number selected by C1 (EDC1 to 6) and C2 (EDC0 to 6) is added to C1 and C2 and output every 73500 frames.

**\$DX commands**

Command	Data 1			
	D23	D22	D21	D20
CLV CTRL	0	TB	TP	Gain CLVS

See "\$CX commands".

Command bit	Description
TB = 0	Bottom hold at a cycle of RFCK/32 in CLVS mode.
TB = 1	Bottom hold at a cycle of RFCK/16 in CLVS mode.
TP = 0	Peak hold at a cycle of RFCK/4 in CLVS mode.
TP = 1	Peak hold at a cycle of RFCK/2 in CLVS mode.

Command	Data 2				Data 3				Data 4			
	D19	D18	D17	D16	D15	D14	D13	D12	D11	D10	D9	D8
CLV CTRL	VP7	VP6	VP5	VP4	VP3	VP2	VP1	VP0	VP CTL1	VP CTL0	0	0

The settings are as follows in CAV-W mode.

Command bit	Processing
VP0 to 7	The spindle rotational velocity is set.

Command bit		Processing
VPCTL1	VPCTL0	
0	0	The setting of VP0 to 7 is multiplied by 1.
0	1	The setting of VP0 to 7 is multiplied by 2.
1	0	The setting of VP0 to 7 is multiplied by 3.
1	1	The setting of VP0 to 7 is multiplied by 4.

\* The above setting should be 0, 0 except for the CAV-W operating mode.

The rotational velocity R of the spindle can be expressed with the following equation.

$$R = \frac{256 - n}{32} \times I$$

R: Relative velocity at normal speed = 1

n: VP0 to 7 setting value

I: Multiple set by VPCTL0, 1

Command bit	Description
VP0 to 7 = F0 (H)	Playback at 1/2 (1) × speed
⋮	⋮
VP0 to 7 = E0 (H)	Playback at 1 (2) × speed
⋮	⋮
VP0 to 7 = C0 (H)	Playback at (4) × speed

**Notes)**

1. Values when crystal is 16.9344MHz and XTSL is low or when crystal is 33.8688MHz and XTSL is high.
2. The values in parentheses are for when DSPB is 1.

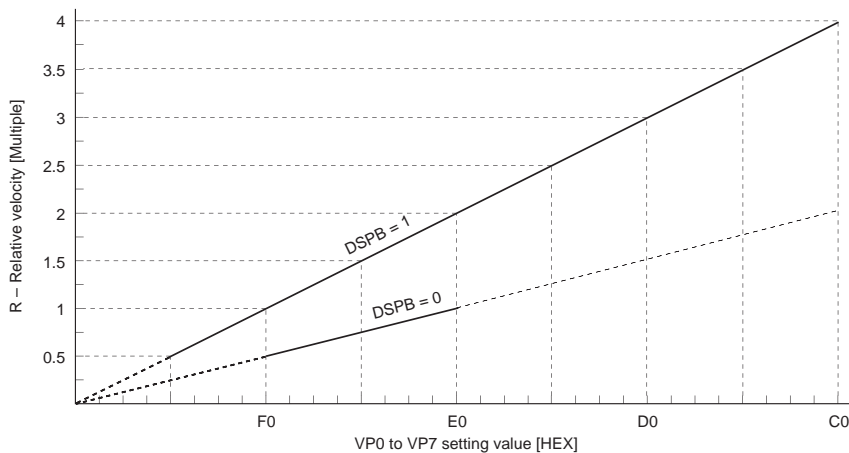

The setting in variable pitch mode is as shown below.

Command bit	Processing
VPCTL1 to 0, VP7 to 0	The pitch of variable pitch mode is set.

The setting of the pitch can be expressed with the equation below.

$$P = \frac{-n}{10} [\%]$$

P: Setting value of pitch  
 n: Setting value for VPCTL1, VPCTL0 and VP7 to VP0 (two's complementary, VPCTL1 is sign bit)

Command bit			Setting value of pitch [%]	Example of command setting
VPCTL1	VPCTL0	VP7 to 0		
1	0	00 (H)	+51.2	\$D60080
		:	:	:
		FF (H)	+25.7	\$D6FF80
1	1	00 (H)	+25.6	\$D600C0
		:	:	:
		FF (H)	+0.1	\$D6FFC0
0	0	00 (H)	0.0	\$D60000
		:	:	:
		FF (H)	-25.5	\$D6FF00
0	1	00 (H)	-25.6	\$D60040
		:	:	:
		FF (H)	-48.7	\$D6E740

The setting range of the pitch is -48.7 to +51.2%.

The pitch setting for + side should be within the playback speed of the recommended operating conditions.

The following is the example of the command in variable pitch mode.

- \$A4XXXXX (Sets to use variable pitch mode)
- \$ACXXXXX (Variable pitch mode is turned on. The VCO2 is the reference to the internal clock.)
- \$D60A00 (The pitch is set to +1.0%)
- \$D60000 (The pitch is set to 0.0%)
- \$A4XXXXX (Variable pitch mode is turned off. The crystal is the reference to the internal clock.)

**\$EX commands**

Command	Data 1				Data 2				Data 3			
	D23	D22	D21	D20	D19	D18	D17	D16	D15	D14	D13	D12
SPD mode	CM3	CM2	CM1	CM0	EPWM	SPDC	ICAP	SFSL	VC2C	HIFC	LPWR	VPON

Command bit				Mode	Description
CM3	CM2	CM1	CM0		
0	0	0	0	STOP	Spindle stop mode.*1
1	0	0	0	KICK	Spindle forward rotation mode.*1
1	0	1	0	BRAKE	Spindle reverse rotation mode. Valid only when LPWR = 0 in any mode.*1
1	1	1	0	CLVS	Rough servo mode. When the RF-PLL circuit isn't locked, this mode is used to pull the disc rotations within the RF-PLL capture range.
1	1	1	1	CLVP	PLL servo mode.
0	1	1	0	CLVA	Automatic CLVS/CLVP switching mode. Used for normal playback.

\*1 See Timing Charts 1-6 to 1-12.

Command bit									Mode	Description
EPWM	SPDC	ICAP	SFSL	VC2C	HIFC	LPWR	VPON	INV VPCO		
0	0	0	0	0	0	0	0	0	CLV-N	Crystal reference CLV servo.
0	0	0	0	1	1	0	0	0	CLV-W	Used for playback in CLV-W mode.*2
0	1	1	0	0	1	0	1	0	CAV-W	Spindle control with VP0 to 7.
1	0	1	0	0	1	0	1	0	CAV-W	Spindle control with the external PWM.
0	0	0	0	0	1	0	1	1	VCO-C	VCO control*3

\*2 Figs. 3-1 and 3-2 show the control flow with the microcomputer software in CLV-W mode.

\*3 Fig. 3-3 shows the control flow with the microcomputer software in VCO-C mode.

Mode	LPWR	Command	Timing chart
CLV-N	0	KICK	1-6 (a)
		BRAKE	1-6 (b)
		STOP	1-6 (c)
CLV-W	0	KICK	1-7 (a)
		BRAKE	1-7 (b)
		STOP	1-7 (c)
	1	KICK	1-8 (a)
		BRAKE	1-8 (b)
		STOP	1-8 (c)
CAV-W	0	KICK	1-9 (a)
		BRAKE	1-9 (b)
		STOP	1-9 (c)
	1	KICK	1-10 (a)
		BRAKE	1-10 (b)
		STOP	1-10 (c)

Mode	LPWR	Timing chart
CLV-N	0	1-11
CLV-W	0	1-12
	1	1-13
CAV-W	0	1-14 (EPWM = 0)
	1	1-15 (EPWM = 0)
	0	1-16 (EPWM = 1)
	1	1-17 (EPWM = 1)

Command	Data 4			
	D11	D10	D9	D8
SPD mode	Gain CAV1	Gain CAV0	0	0

Gain CAV1	Gain CAV0	Gain
0	0	0dB
0	1	-6dB
1	0	-12dB
1	1	-18dB

- This sets the gain when controlling the spindle with the phase comparator in CAV-W mode.

Timing Chart 1-3

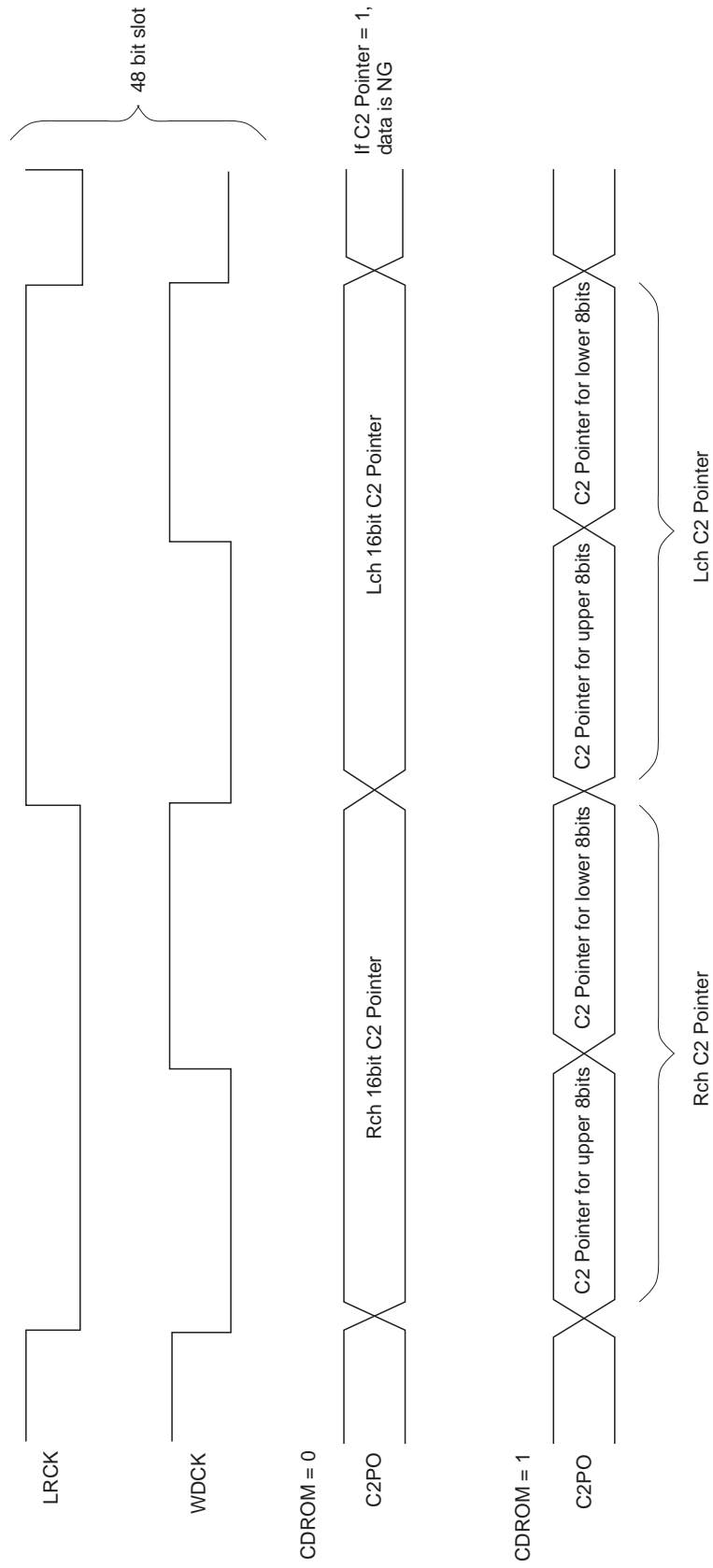

Timing Chart 1-4

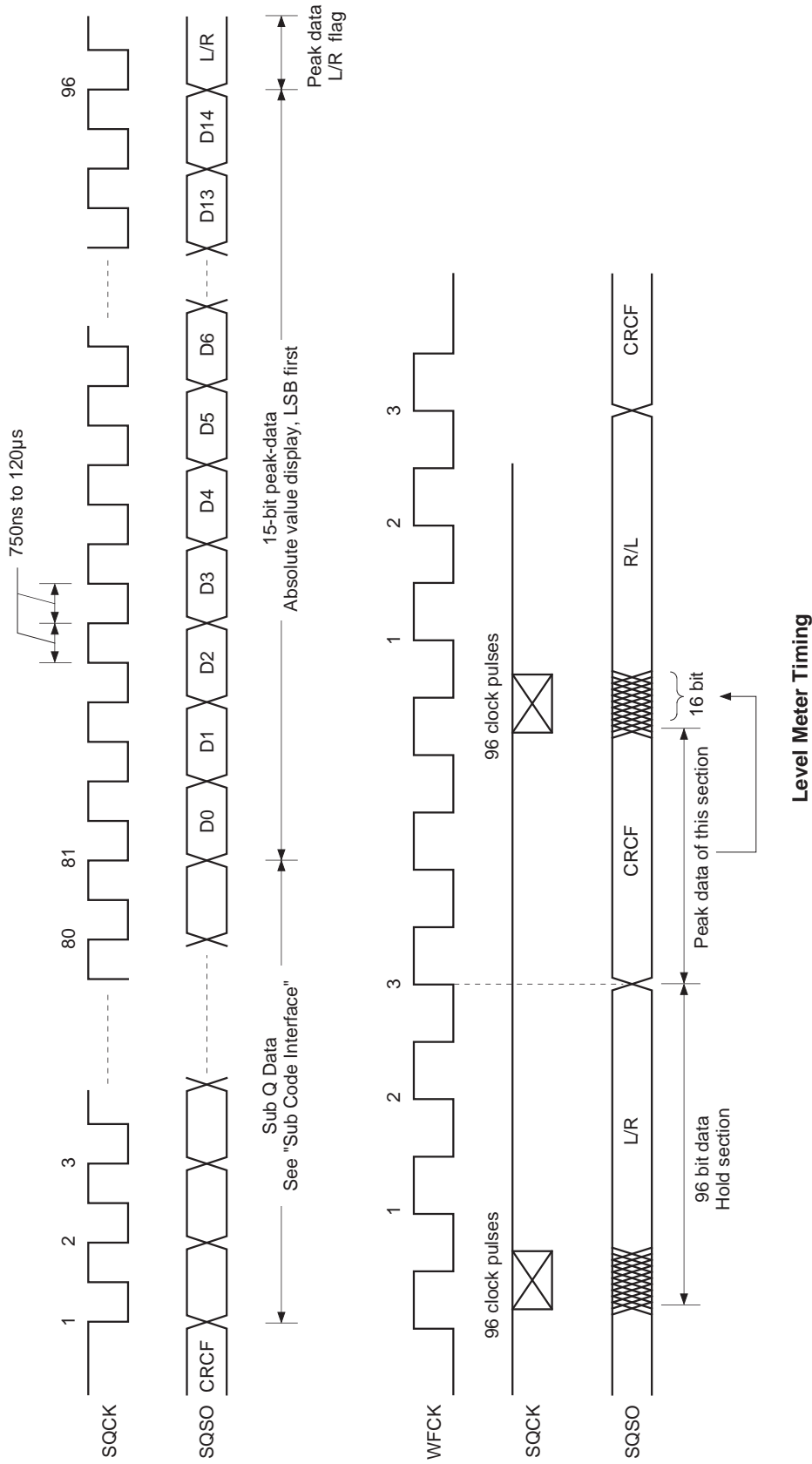



Timing Chart 1-5

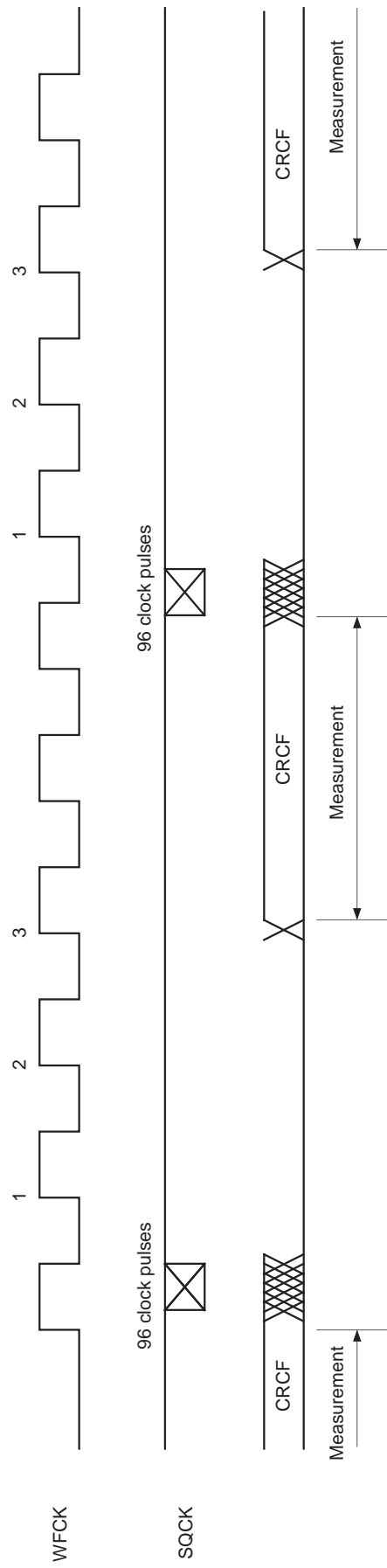

Peak Meter Timing

**Timing Chart 1-6**

**CLV-N mode LPWR = 0**

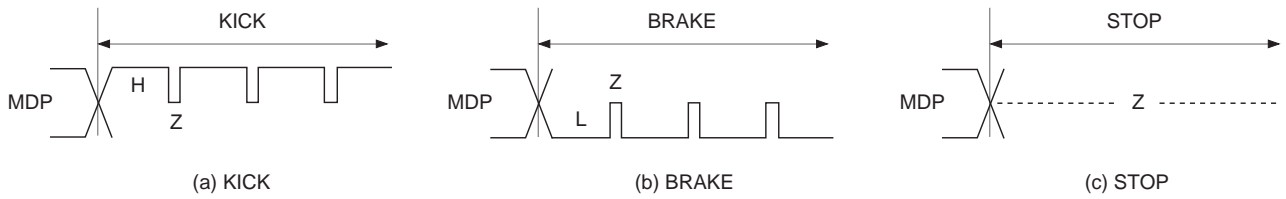

**Timing Chart 1-7**

**CLV-W mode (when following the spindle rotational velocity) LPWR = 0**

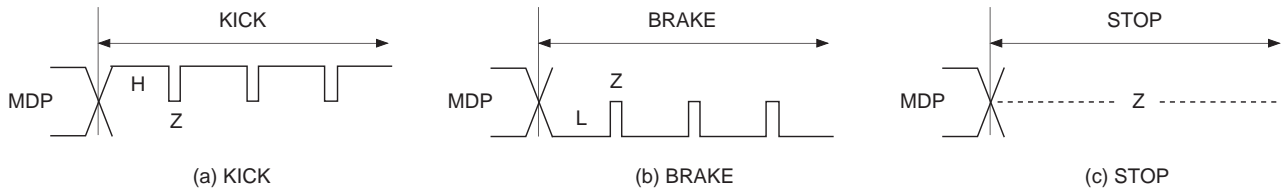

**Timing Chart 1-8**

**CLV-W mode (when following the spindle rotational velocity) LPWR = 1**

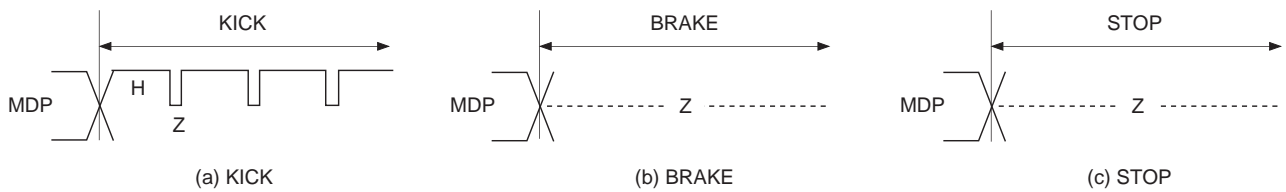

**Timing Chart 1-9**

**CAV-W mode LPWR = 0**

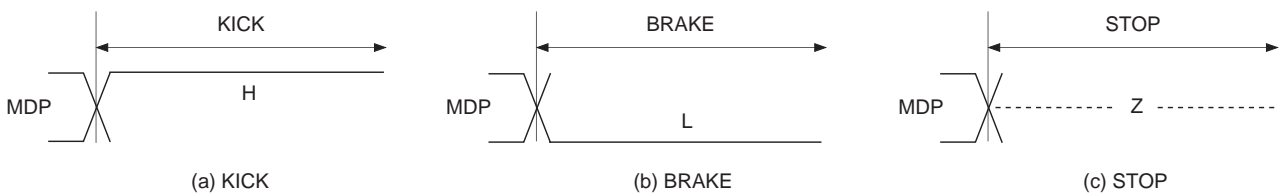

**Timing Chart 1-10**

**CAV-W mode LPWR = 1**

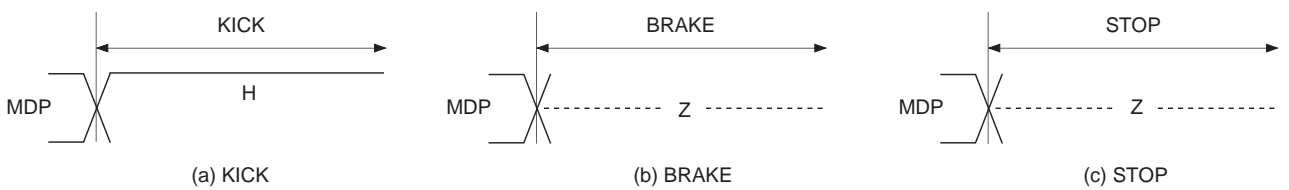

**Timing Chart 1-11**

**CLV-N mode LPWR = 0**

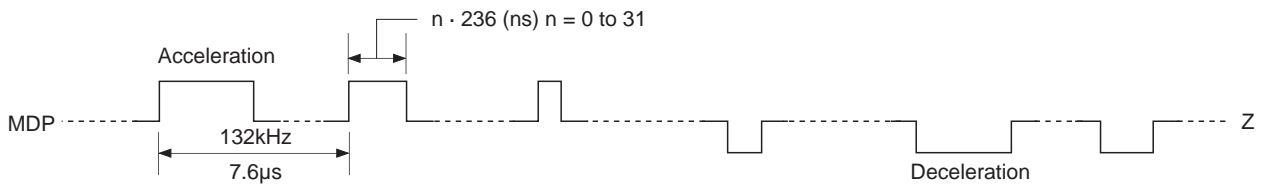

**Timing Chart 1-12**

**CLV-W mode LPWR = 0**

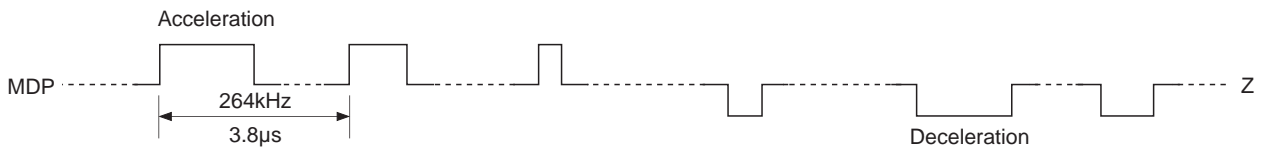

**Timing Chart 1-13**

**CLV-W mode LPWR = 1**

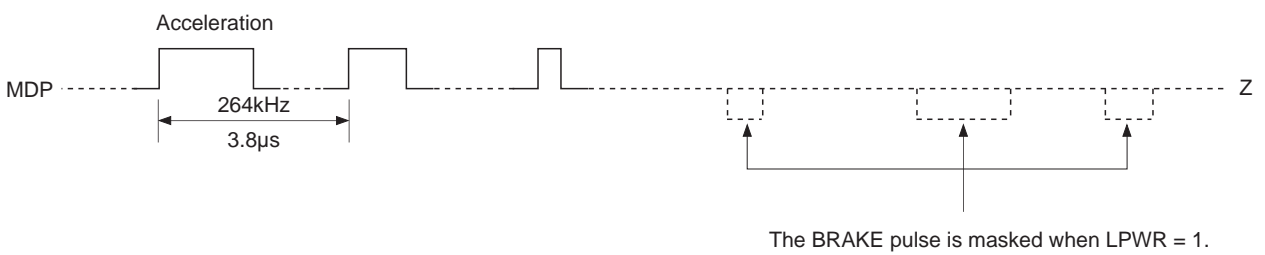

**Timing Chart 1-14**

**CAV-W mode EPWM = LPWR = 0**

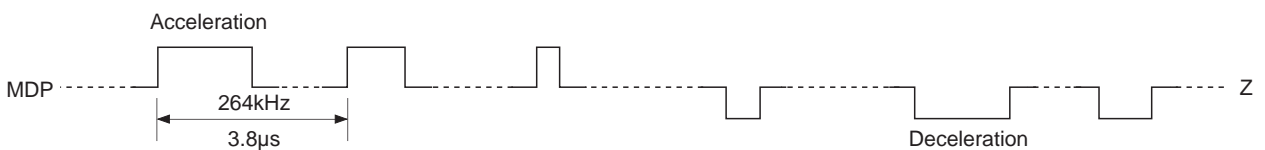

**Timing Chart 1-15**

**CAV-W mode EPWM = LPWR = 1**

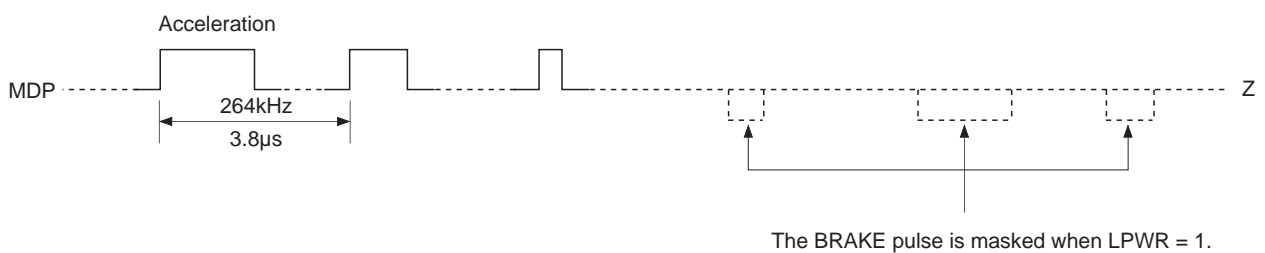

**Timing Chart 1-16**

**CAV-W mode** EPWM = 1, LPWR = 0

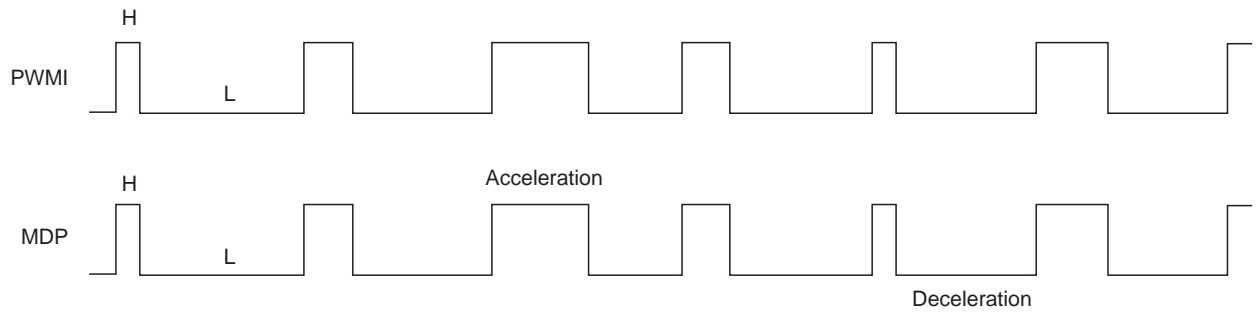

**Timing Chart 1-17**

**CAV-W mode** EPWM = LPWR = 1

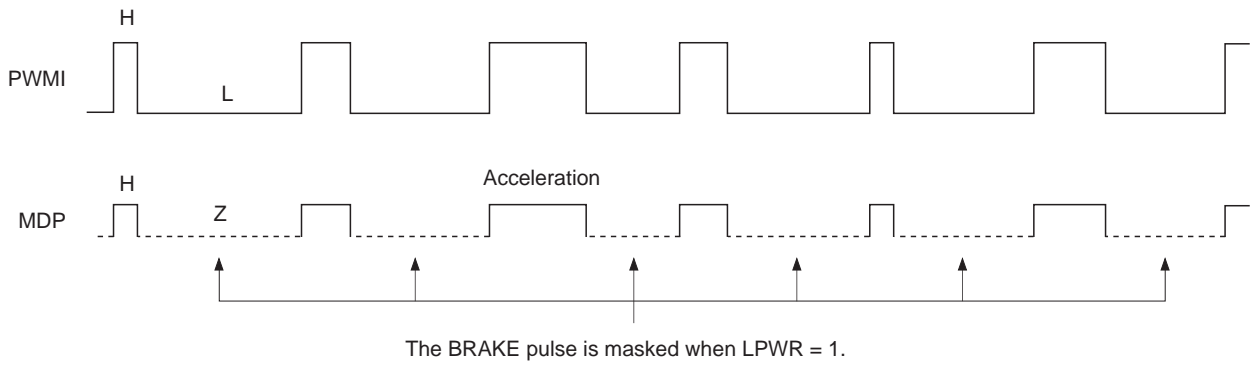

## [2] Subcode Interface

There are two methods for reading out a subcode externally.

The 8-bit subcodes P to W can be read out from SBSO by inputting EXCK.

Sub-Q can be read out after checking CRC of the 80 bits in the subcode frame.

Sub-Q can be read out from the SQSO pin by inputting 80 clock pulses to the SQCK pin when SCOR comes correctly and CRCF is high.

### § 2-1. P to W Subcode Readout

Data can be read out by inputting EXCK immediately after WFCK falls. (See Timing Chart 2-1.)

### § 2-2. 80-bit Sub-Q Readout

Fig. 2-2 shows the peripheral block of the 80-bit Sub-Q register.

- First, Sub-Q, regenerated at one bit per frame, is input to the 80-bit serial/parallel register and the CRC check circuit.

- 96-bit Sub-Q is input, and if the CRC is OK, it is output to SQSO with CRCF = 1. In addition, 80 bits are loaded into the parallel/serial register.

When SQSO goes high after SCOR is output, the CPU determines that new data (which passed the CRC check) has been loaded.

- When the 80-bit data is loaded, the order of the MSB and LSB is inverted within each byte. As a result, although the sequence of the bytes is the same, the bits within the bytes are now ordered LSB first.

- Once the 80-bit data load is confirmed, SQCK is input so that the data can be read.

The SQCK input is detected, and the retriggerable monostable multivibrator is reset while the input is low.

- The retriggerable monostable multivibrator has a time constant from 270 to 400 $\mu$ s. When the duration when SQCK is high is less than this time constant, the monostable multivibrator is kept reset; during this interval, the serial/parallel register is not loaded into the parallel/serial register.

- While the monostable multivibrator is being reset, data cannot be loaded in the peak detection parallel/serial register or the 80-bit parallel/serial register.

In other words, while reading out with a clock cycle shorter than this time constant, the register will not be rewritten by CRCOK and others.

- The previously mentioned peak detection register can be connected to the shift-in of the 80-bit parallel/serial register.

For ring control 1, input and output are shorted during peak meter and level meter modes.

For ring control 2, input and output are shorted during peak meter mode.

This is because the register is reset with each readout in level meter mode, and to prevent readout destruction in peak meter mode.

As a result, the 96-bit clock must be input in peak meter mode.

- The absolute time after peak is stored in the memory in peak meter mode. (See Timing Chart 2-3.)
- The high and low intervals for SQCK should be between 750ns and 120 $\mu$ s.

Timing Chart 2-1

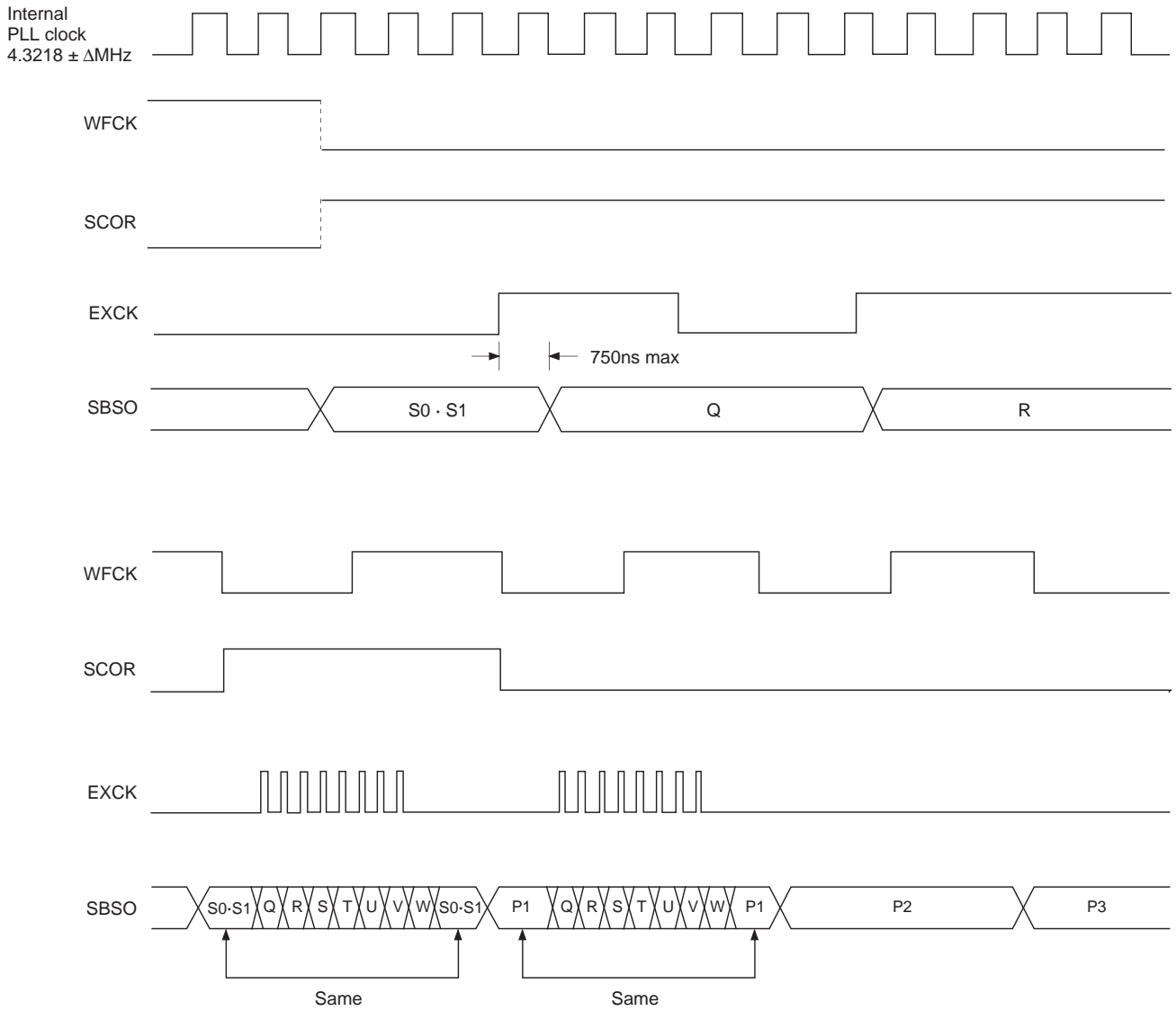

Subcode P.Q.R.S.T.U.V.W Read Timing

Block Diagram 2-2

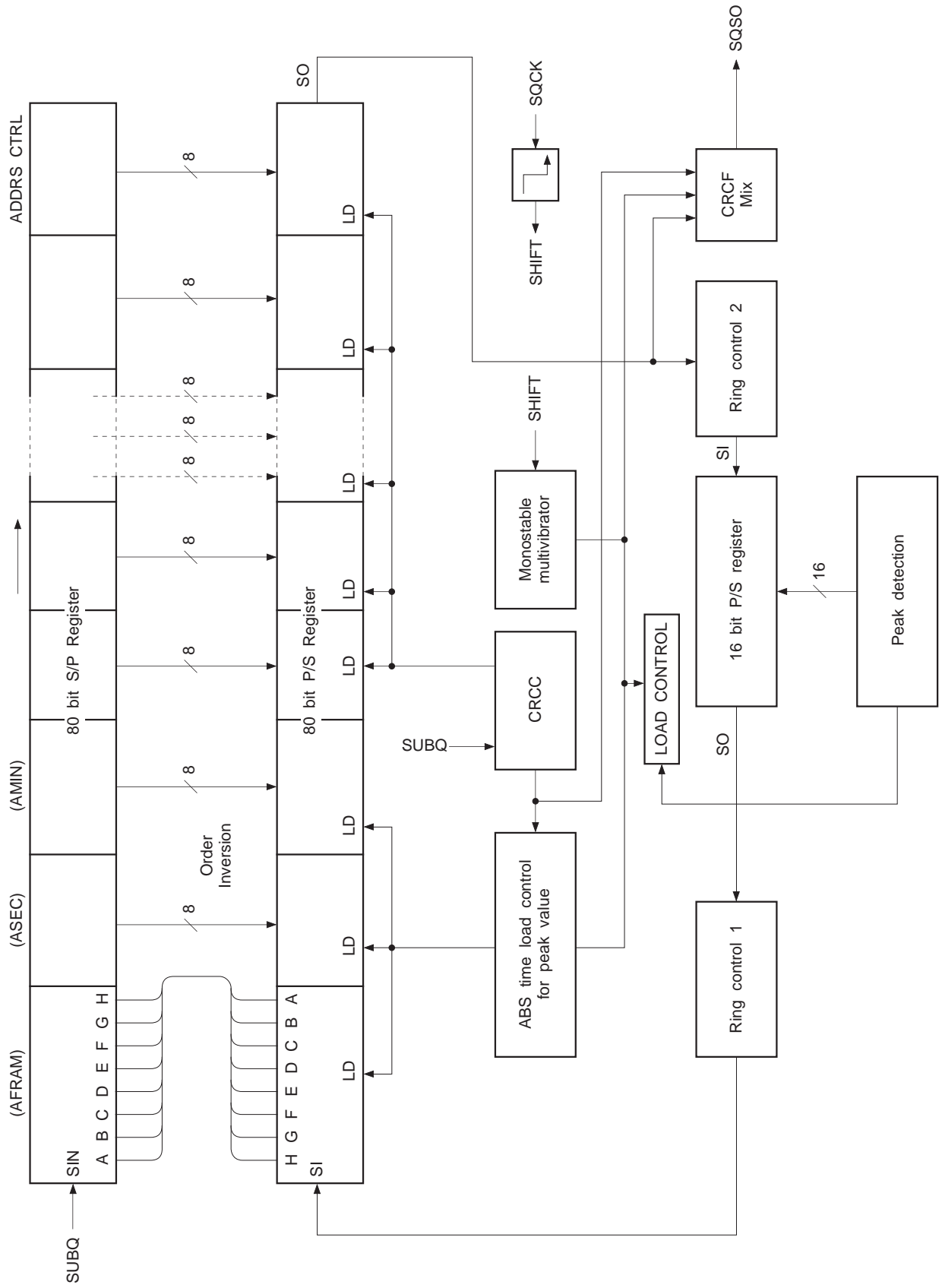

Timing Chart 2-3

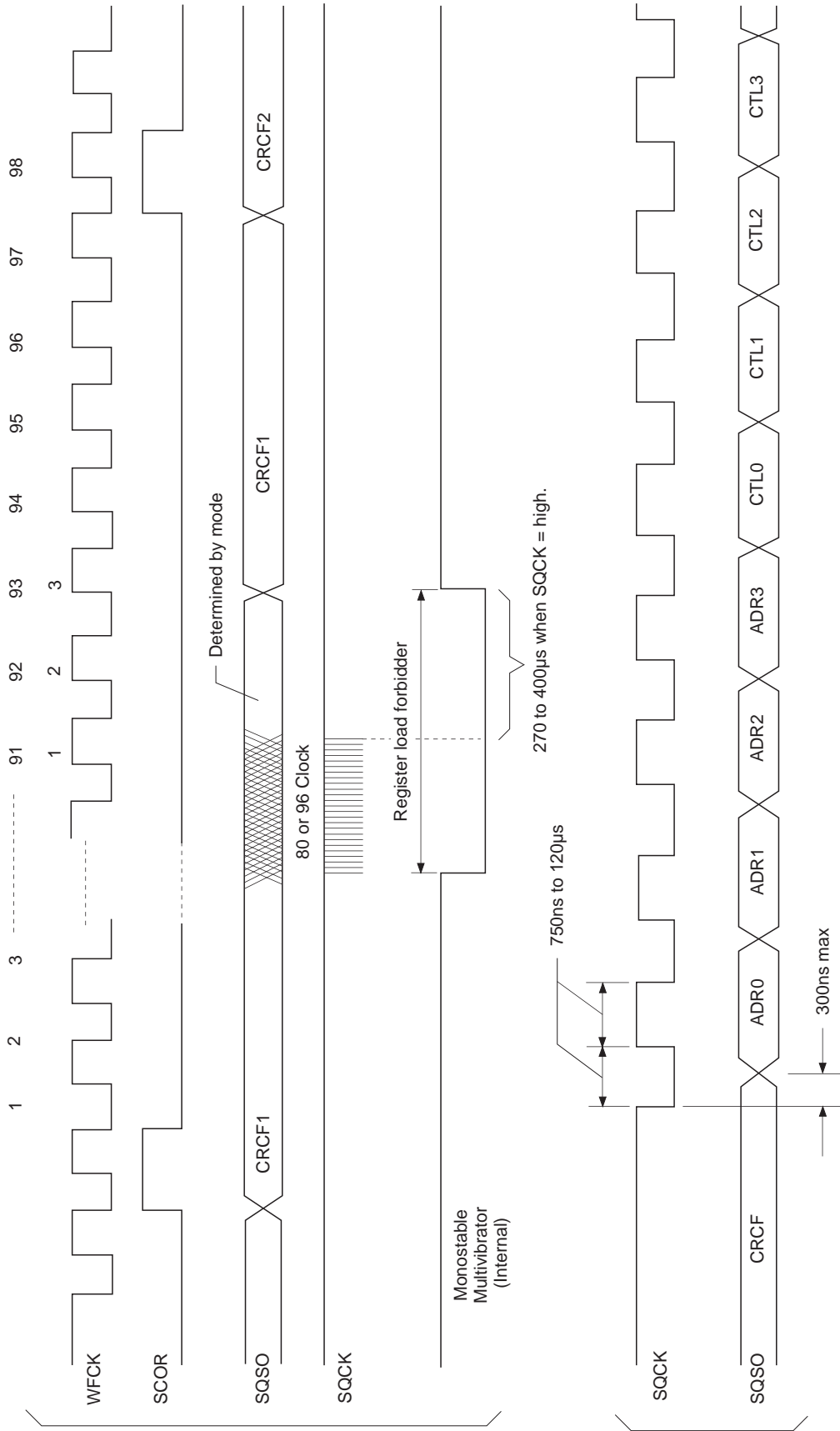



Timing Chart 2-4

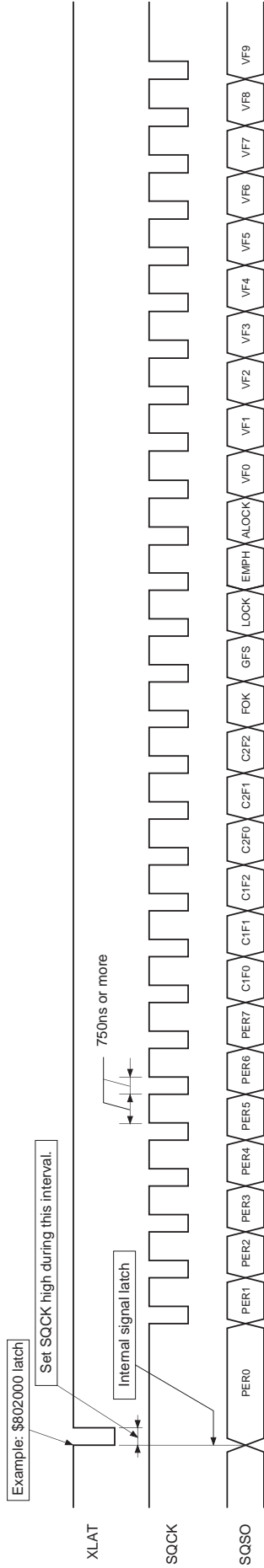

Signal	Description
PER0 to 7	RF jitter amount (used to adjust the focus bias). 8-bit binary data in PER0 = LSB, PER7 = MSB.
FOK	Focus OK.
GFS	High when the frame sync and the insertion protection timing match.
LOCK	GFS is sampled at 460Hz; when GFS is high, this pin outputs a high signal. If GFS is low eight consecutive samples, this pin outputs low.
EMPH	High when the playback disc has emphasis.
ALOCK	GFS is sampled at 460Hz; when GFS is high eight consecutive samples, this pin outputs a high signal. If GFS is low eight consecutive samples, this pin outputs low.
VF0 to 9	Used in CAV-W mode. The result obtained by measuring the rotational velocity of the disc. (See Timing Chart 2-5.) VF0 = LSB, VF9 = MSB.

C1F2	C1F1	C1F0	Description
0	0	0	No C1 errors; C1 pointer reset
0	0	1	One C1 error corrected; C1 pointer reset
0	1	0	—
0	1	1	—
1	0	0	No C1 errors; C1 pointer set
1	0	1	One C1 error corrected; C1 pointer set
1	1	0	Two C1 errors corrected; C1 pointer set
1	1	1	C1 correction impossible; C1 pointer set

C2F2	C2F1	C2F0	Description
0	0	0	No C2 errors; C2 pointer reset
0	0	1	One C2 error corrected; C2 pointer reset
0	1	0	Two C2 errors corrected; C2 pointer reset
0	1	1	Three C2 errors corrected; C2 pointer reset
1	0	0	Four C2 errors corrected; C2 pointer reset
1	0	1	—
1	1	0	C2 correction impossible; C1 pointer copy
1	1	1	C2 correction impossible; C2 pointer set

Timing Chart 2-5

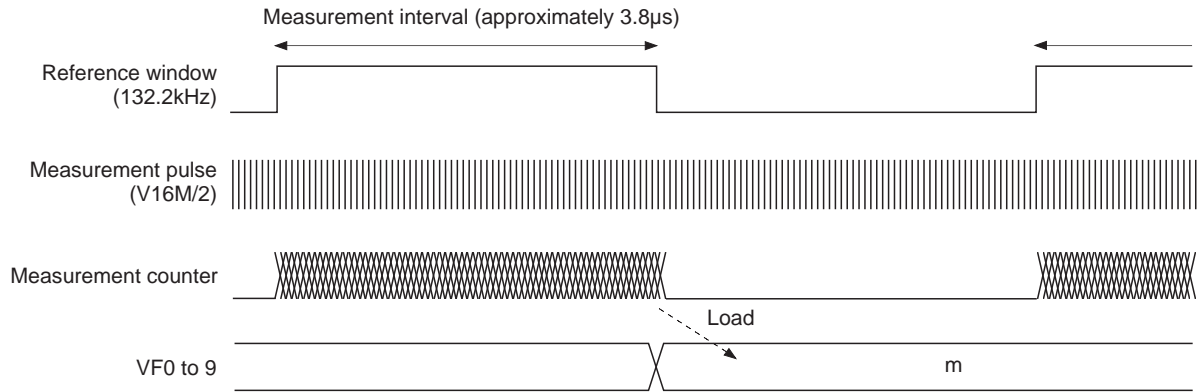

The relative velocity of the disc can be obtained with the following equation.

$$R = \frac{(m + 1)}{32} \quad (R: \text{Relative velocity, } m: \text{Measurement results})$$

VF0 to 9 is the result obtained by counting V16M/2 pulses while the reference signal (132.2kHz) generated from XTAL (XTAI, XTAO) (384Fs) is high. This value is 31 when the disc is rotating at normal speed and 63 when it is rotating at double speed (when DSPB is low).

Timing Chart 2-6

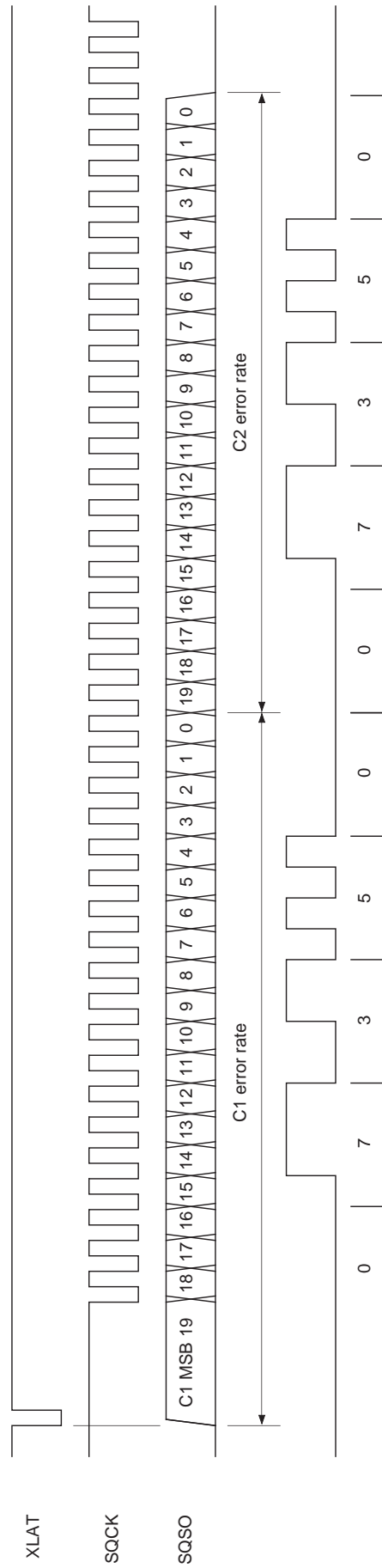

### [3] Description of Modes

This LSI has three basic operating modes using a combination of spindle control and the PLL. The operations for each mode are described below.

#### § 3-1. CLV-N Mode

This mode is compatible with the CXD2510Q, and operation is the same as for conventional control. The PLL capture range is  $\pm 150\text{kHz}$ .

#### § 3-2. CLV-W Mode

This is the wide capture range mode. This mode allows the PLL to follow the rotational velocity of the disc. This rotational following control has two types: using the built-in VCO2 or providing an external VCO. The spindle is the same CLV servo as for the conventional series. Operation using the built-in VCO2 is described below. (When using an external VCO, input the signal from the VPCO pin to the low-pass filter, use the output from the low-pass filter as the control voltage for the external VCO, and input the oscillation from the VCO to the V16M pin.)

When starting to rotate the disc and/or speeding up to the lock range from the condition where the disc is stopped, CAV-W mode should be used. Specifically, first send  $\$E665X$  to set CAV-W mode and kick the disc, then send  $\$E60CX$  to set CLV-W mode if ALOCK is high, which can be read out serially from the SQSO pin. CLV-W mode can be used while ALOCK is high. The microcomputer monitors the serial data output, and must return the operation to the speed adjusting state (CAV-W mode) when ALOCK becomes low. The control flow according to the microcomputer software in CLV-W mode is shown in Fig. 3-2.

In CLV-W mode (normal), low power consumption is achieved by setting LPWR to high. Control was formerly performed by applying acceleration and deceleration pulses to the spindle motor. However, when LPWR is set high, deceleration pulses are not output, thereby achieving low power consumption mode.

**Note)** The capture range for this mode is theoretically up to the signal processing limit.

#### § 3-3. CAV-W Mode

This is CAV mode. In this mode, the external clock is fixed and it is possible to control the spindle to the desired rotational velocity. The rotational velocity is determined by the VP0 to VP7 setting values or the external PWM. When controlling the spindle with VP0 to VP7, setting CAV-W mode with the  $\$E665X$  command and controlling VP0 to VP7 with the  $\$DX$  commands allows the rotational velocity to be varied from low speed to 4 $\times$  speed. (See " $\$DX$  commands".) Also, when controlling the spindle with the external PWM, the PWMI pin is binary input which becomes KICK during high intervals and BRAKE during low intervals.

The microcomputer can know the rotational velocity using V16M. The reference frequency for the velocity measurement is a signal of 132.3kHz obtained by dividing XTAL (XTAI, XTAO) (384Fs) by 128. The velocity is obtained by counting the half of V16M pulses while the reference is high, and the result is output from the new CPU interface as 10 bits (VP0 to VP9). These measurement results are 31 when the disc is rotating at normal speed or 127 when it is rotating at 4 $\times$  speed. These values match those of the 256 - n for control with VP0 to VP7. (See Table 2-5 and Fig. 2-6.)

In CAV-W mode, the spindle is set to the desired rotational velocity and the operation speed for the entire system follows this rotational velocity. Therefore, the cycles for the Fs system clock, PCM data and others output from this LSI change according to the rotational velocity of the disc.

**Note)** The capture range for this mode is theoretically up to the signal processing limit.

**Note)** Set FLFC to 1 for this mode

### § 3-4. VCO-C Mode

This is VCO control mode. In this mode, the V16M oscillation frequency can be controlled by setting \$D commands VP0 to VP7 and VPCTL0, 1. The V16M oscillation frequency can be expressed by the following equation.

$$V16M = \frac{I(256 - n)}{32}$$

n: VP0 to 7 setting value  
I: VPCTL0, 1 setting value

The VCO1 oscillation frequency is determined by V16M. The VCO1 frequency can be expressed by the following equation.

- When DSPB = 0

$$VCO1 = V16M \times \frac{49}{24}$$

- When DSPB = 1

$$VCO1 = V16M \times \frac{49}{16}$$

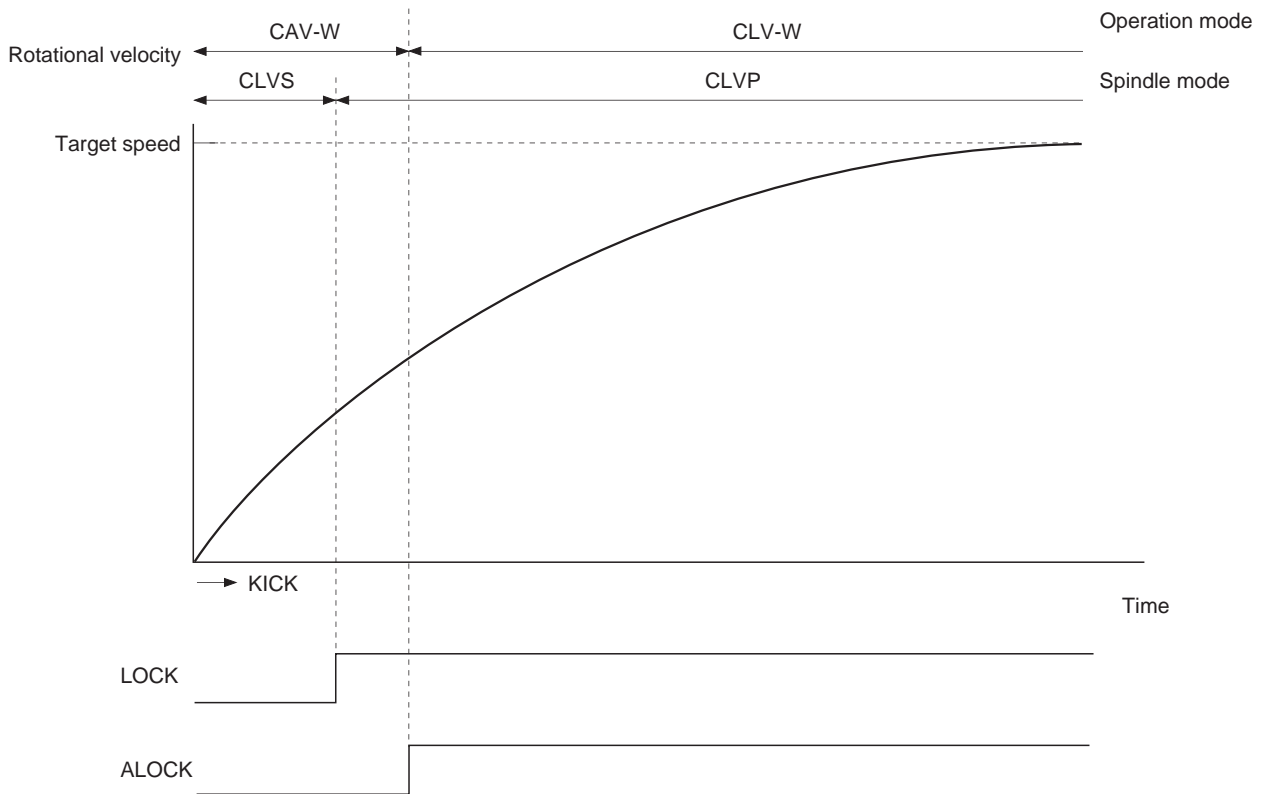

Fig. 3-1. Disc Stop to Regular Playback in CLV-W Mode

CLV-W Mode

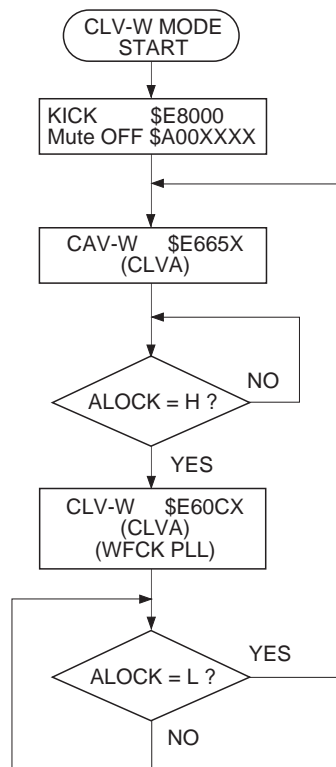

Fig. 3-2. CLV-W Mode Flow Chart

VCO-C Mode

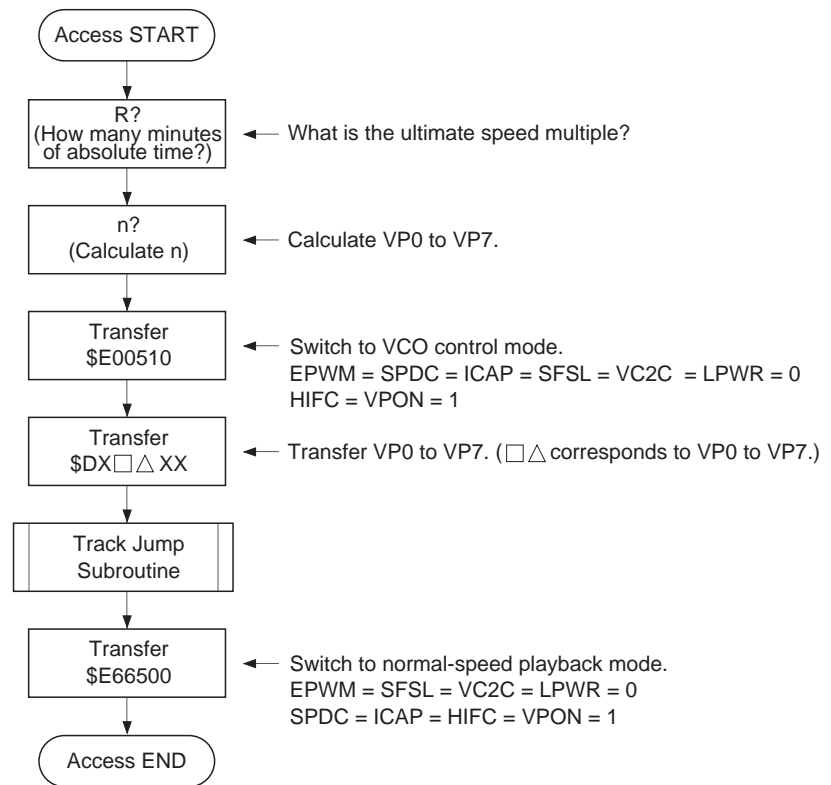

Fig. 3-3. Access Flow Chart Using VCO Control

#### [4] Description of other functions

##### § 4-1. Channel Clock Regeneration by Digital PLL Circuit

- The channel clock is necessary for demodulating the EFM signal regenerated by the optical system.  
Assuming  $T$  as the channel clock cycle, the EFM signal is modulated in an integer multiple of  $T$  from  $3T$  to  $11T$ . In order to read the information in the EFM signal, this integer value must be read correctly. As a result,  $T$ , that is the channel clock, is necessary.  
In an actual player, a PLL is necessary for regenerating the channel clock because the fluctuation in the spindle rotation alters the width of the EFM signal pulses.

The block diagram of this PLL is shown in Fig. 4-1.

The CXD2585Q has a built-in three-stage PLL.

- The first-stage PLL is a wide-band PLL. When using the internal VCO2, an external LPF is necessary; when not using the internal VCO2, external LPF and VCO are necessary.  
The output of this first-stage PLL is used as a reference for all clocks within the LSI.
- The second-stage PLL regenerates the high-frequency clock needed by the third-stage digital PLL.
- The third-stage PLL is a digital PLL that regenerates the actual channel clock.
- The digital PLL in CLV-N mode has a secondary loop, and is controlled by the primary loop (phase) and the secondary loop (frequency). When  $FLFC = 1$ , the secondary loop can be turned off. High frequency components such as  $3T$  and  $4T$  may contain deviations. In such cases, turning the secondary loop off yields better playability. However, in this case the capture range becomes  $\pm 50\text{kHz}$ .
- A new digital PLL has been provided for CLV-W mode to follow the rotational velocity of the disc in addition to the conventional secondary loop.



Block Diagram 4-1

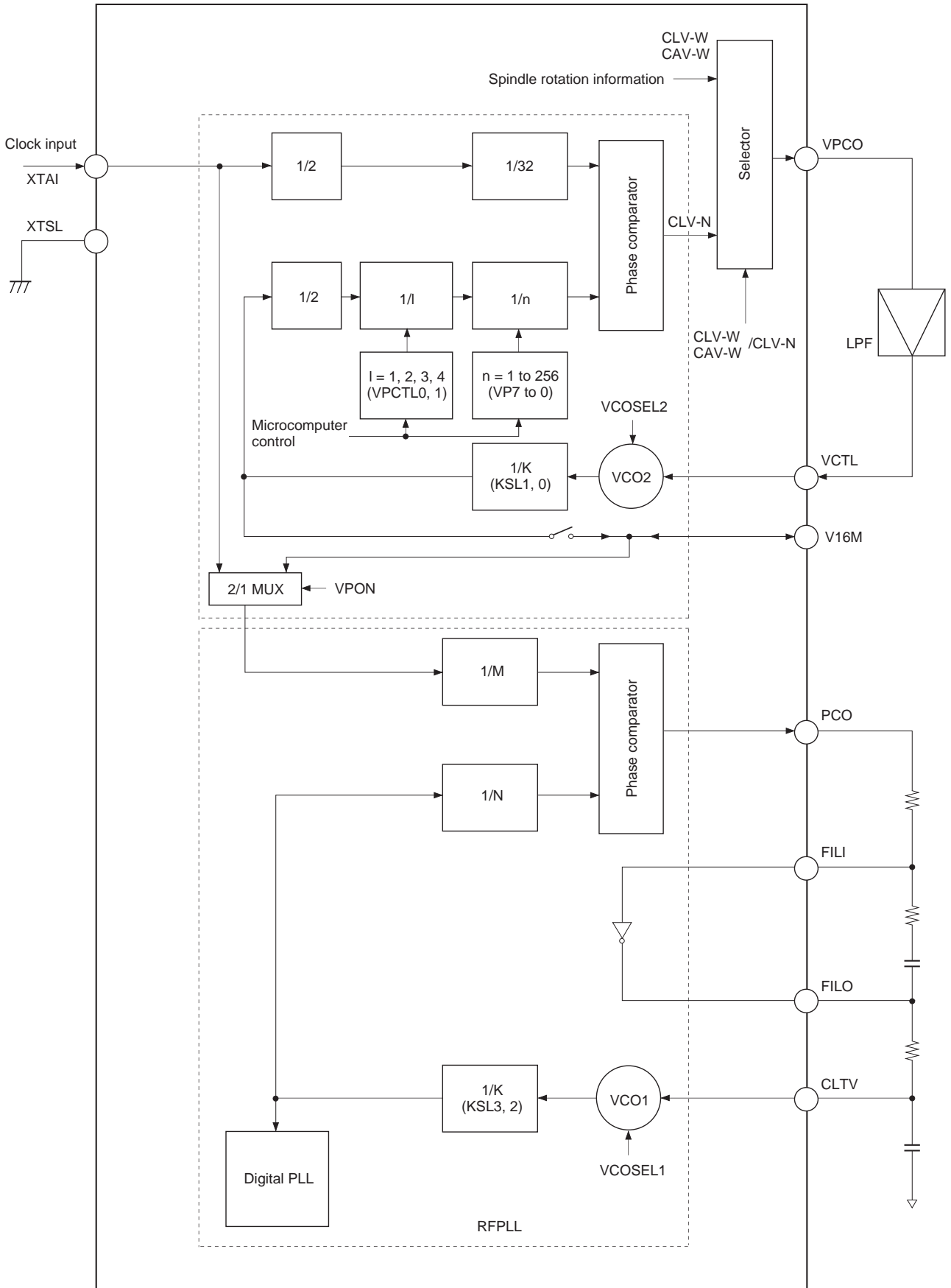

#### § 4-2. Frame sync protection

- In normal speed playback, a frame sync is recorded approximately every 136 $\mu$ s (7.35kHz). This signal is used as a reference to recognize the data within a frame. Conversely, if the frame sync cannot be recognized, the data is processed as error data because the data cannot be recognized. As a result, recognizing the frame sync properly is extremely important for improving playability.
- In the CXD2585Q, window protection and forward protection/backward protection have been adopted for frame sync protection. These functions achieve very powerful frame sync protection. There are two window widths; one for cases where a rotational disturbance affects the player and the other for cases where there is no rotational disturbance (WSEL = 0/1). In addition, the forward protection counter is set to 13\*, and the backward protection counter to 3\*. Concretely, when the frame sync is being played back normally and then cannot be detected due to scratches, a maximum of 13 frames are inserted. If the frame sync cannot be detected for 13 frames or more, the window opens to resynchronize the frame sync.

In addition, immediately after the window opens and the resynchronization is executed, if a proper frame sync cannot be detected within 3 frames, the window opens immediately.

\* Default values. These values can be set as desired by \$C commands SFP0 to SFP3 and SRP0 to SRP3.

#### § 4-3. Error Correction

- In the CD format, one 8-bit data contains two error correction codes, C1 and C2. For C1 correction, the code is created with 28-byte information and 4-byte C1 parity.  
For C2 correction, the code is created with 24-byte information and 4-byte parity.  
Both C1 and C2 are Reed Solomon codes with a minimum distance of 5.
- The CXD2585Q uses refined super strategy to achieve double correction for C1 and quadruple correction for C2.
- In addition, to prevent C2 miscorrection, a C1 pointer is attached to data after C1 correction according to the C1 error status, the playback status of the EFM signal, and the operating status of the player.
- The correction status can be monitored externally.  
See Table 4-2.
- When the C2 pointer is high, the data in question was uncorrectable. Either the pre-value was held or an average value interpolation was made for the data.

MNT3	MNT2	MNT1	MNT0	Description
0	0	0	0	No C1 errors; C1 pointer reset
0	0	0	1	One C1 error corrected; C1 pointer reset
0	0	1	0	—
0	0	1	1	—
0	1	0	0	No C1 errors; C1 pointer set
0	1	0	1	One C1 error corrected; C1 pointer set
0	1	1	0	Two C1 errors corrected; C1 pointer set
0	1	1	1	C1 correction impossible; C1 pointer set
1	0	0	0	No C2 errors; C2 pointer reset
1	0	0	1	One C2 error corrected; C2 pointer reset
1	0	1	0	Two C2 errors corrected; C2 pointer reset
1	0	1	1	Three C2 errors corrected; C2 pointer reset
1	1	0	0	Four C2 errors corrected; C2 pointer reset
1	1	0	1	—
1	1	1	0	C2 correction impossible; C1 pointer copy
1	1	1	1	C2 correction impossible; C2 pointer set

Table 4-2.

Timing Chart 4-3

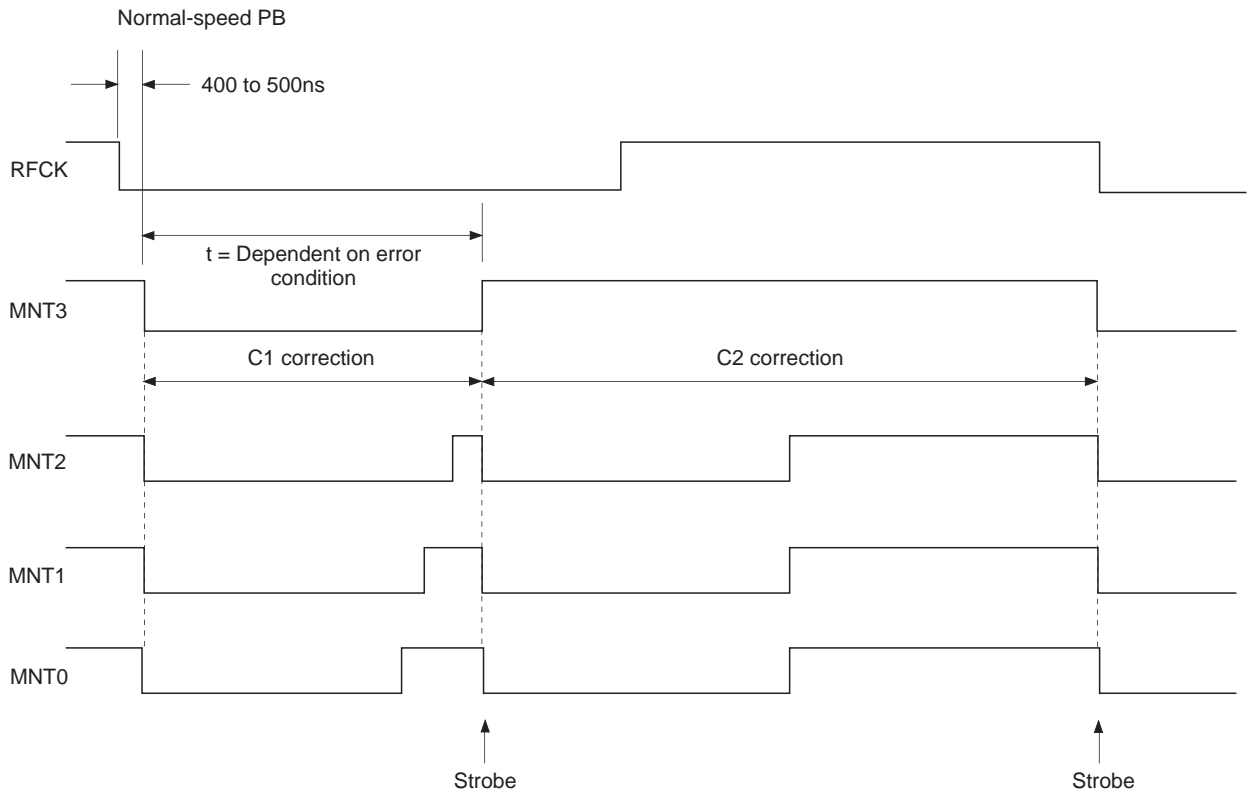

§ 4-4. DA Interface

- The CXD2585Q supports the 48-bit slot interface as the DA interface.

48-bit slot interface

This interface includes 48 cycles of the bit clock within one LRCK cycle, and is MSB first.

When LRCK is high, the data is for the left channel.

Timing Chart 4-4

48bit slot Normal-Speed Playback PSSL = L

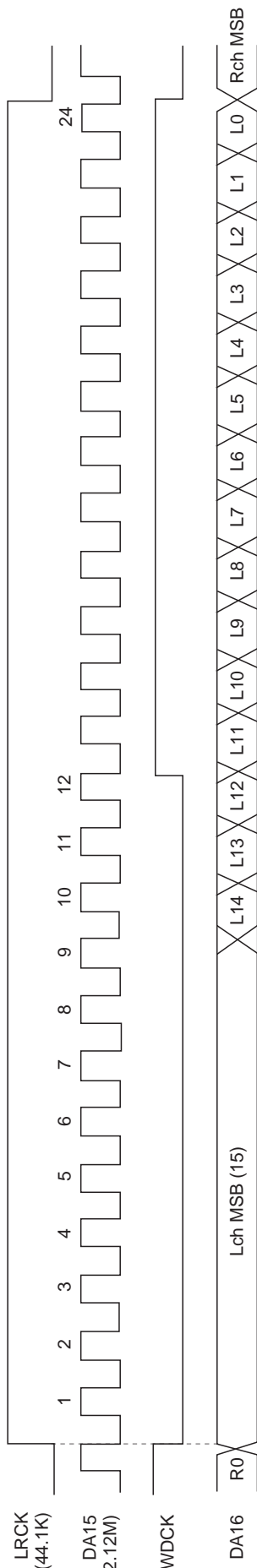

48bit slot Double-Speed Playback

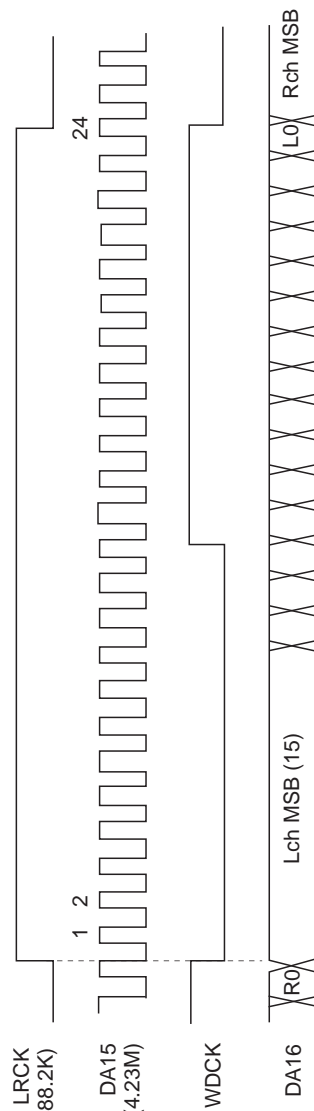

§ 4-5. Digital Out

There are three Digital Out: the type 1 format for broadcasting stations, the type 2 form 1 format for home use, and the type 2 form 2 format for the manufacture of software.

The CXD2585Q supports type 2 form 1.

The channel status clock accuracy is automatically set to level II when using the crystal clock and to level III in CAV-W mode or variable pitch mode. In addition, Sub-Q data which are matched twice in succession after a CRC check are input to the first four bits (bits 0 to 3).

DOUT is output when the crystal is 34MHz and DSPB is set to 1 with XTSL high in CLV-N or CLV-W mode. Therefore, set MD2 to 0 and turn DOUT off.

Digital Out C bit

	0	1	2	3	4	5	6	7	8	9	10	11	12	13	14	15
0	From sub Q ← ID0   ID1   COPY   Emph →				0	0	0	0	1	0	0	0	0	0	0	0
16	0	0	0	0	0	0	0	0	0	0	0	0	0	0/1	0	0
32	0															
48																
64																
176																

bit0 to 3 Sub-Q control bits that matched twice with CRCOK  
 bit29 VPON or VARION: 1 X'tal: 0

Table 4-5.

#### § 4-6. Servo Auto Sequence

This function performs a series of controls, including auto focus and track jumps. When the auto sequence command is received from the CPU, auto focus, 1-track jump, 2N-track jump, fine search and M-track move are executed automatically.

The servo block operates according to the built-in program during the auto sequence execution (when XBUSY = low), so that commands from the CPU, that is \$0, 1, 2 and 3 commands, are not accepted. (\$4 to E commands are accepted.)

In addition, when using the auto sequence, turn the A.SEQ of register 9 on.

When CLOK goes from low to high while XBUSY is low, XBUSY does not become high for a maximum of 100 $\mu$ s after that point. This is to prevent the transfer of erroneous data to the servo when XBUSY changes from low to high by the monostable multivibrator, which is reset by CLOK being low (when XBUSY is low).

In addition, a MAX timer is built into this LSI as a countermeasure against abnormal operation due to external disturbances, etc. When the auto sequence command is sent from the CPU, this command assumes a \$4XY format, in which X specifies the command and Y sets the MAX timer value and timer range. If the executed auto sequence command does not terminate within the set timer value, the auto sequence is interrupted (like \$40). See [1] "\$4X commands" concerning the timer value and range. Also, the MAX timer is invalidated by inputting \$4X0.

Although this command is explained in the format of \$4X in the following command descriptions, the timer value and timer range are actually sent together from the CPU.

##### (a) Auto focus (\$47)

Focus search-up is performed, FOK and FZC are checked, and the focus servo is turned on.

If \$47 is received from the CPU, the focus servo is turned on according to Fig. 4-6. The auto focus starts with focus search-up, and note that the pickup should be lowered beforehand (focus search-down). In addition, blind E of register 5 is used to eliminate FZC chattering. Concretely, the focus servo is turned on at the falling edge of FZC after FZC has been continuously high for a longer time than E.

##### (b) Track jump

1, 10 and 2N-track jumps are performed respectively. Always use this when the focus, tracking, and sled servos are on. Note that tracking gain-up and braking-on (\$17) should be sent beforehand because they are not involved in this sequence.

###### • 1-track jump

When \$48 (\$49 for REV) is received from the CPU, a FWD (REV) 1-track jump is performed in accordance with Fig. 4-7. Set blind A and brake B with register 5.

###### • 10-track jump

When \$4A (\$4B for REV) is received from the CPU, a FWD (REV) 10-track jump is performed in accordance with Fig. 4-8. The principal difference from the 1-track jump is to kick the sled. In addition, after kicking the actuator, when 5 tracks have been counted through COUT, the brake is applied to the actuator. Then, when the actuator speed is found to have slowed up enough (determined by the COUT cycle becoming longer than the overflow C set with register 5), the tracking and sled servos are turned on.

- 2N-track jump

When \$4C (\$4D for REV) is received from the CPU, a FWD (REV) 2N-track jump is performed in accordance with Fig. 4-9. The track jump count N is set with register 7. Although N can be set to  $2^{16}$  tracks, note that the setting is actually limited by the actuator. COUT is used for counting the number of jumps when N is less than 16, and MIRR is used with N is 16 or more.

Although the 2N-track jump basically follows the same sequence as the 10-track jump, the one difference is that after the tracking servo is turned on, the sled continues to move only for "D", set with register 6.

- Fine search

When \$44 (\$45 for REV) is received from the CPU, a FWD (REV) fine search (N-track jump) is performed in accordance with Fig. 4-10. The differences from a 2N-track jump are that a higher precision is achieved by controlling the traverse speed, and a longer distance jump is achieved by controlling the sled. The track jump count is set with register 7. N can be set to  $2^{16}$  tracks. After kicking the actuator and sled, the traverse speed is controlled based on the overflow G. Set kick D and F with register 6 and overflow G with register 5. Also, sled speed control during traverse can be turned off by causing COMP to fall. Set the number of tracks during which COMP falls with register B. After N tracks have been counted through COUT, the brake is applied to the actuator and sled. (This is performed by turning on the tracking servo for the actuator, and by kicking the sled in the opposite direction during the time for kick D set with register 6.) Then, the tracking and sled servos are turned on.

Set overflow G to the speed required to slow up just before the track jump terminates. (The speed should be such that it will come on-track when the tracking servo turns on at the termination of the track jump.) For example, set the target track count  $N - \alpha$  for the traverse monitor counter which is set with register B, and COMP will be monitored. When the falling edge of this COMP is detected, overflow G can be reset.

- M-track move

When \$4E (\$4F for REV) is received from the CPU, a FWD (REV) M-track move is performed in accordance with Fig. 4-11. M can be set to  $2^{16}$  tracks. Like the 2N-track jump, COUT is used for counting the number of moves when M is less than 16, and MIRR is used when M is 16 or more. The M-track move is executed by moving only the sled, and is therefore suited for moving across several thousand to several ten-thousand tracks. In addition, the track and sled servos are turned off after M tracks have been counted through COUT or MIRR unlike for the other jumps. Transfer \$25 from the microcomputer after the actuator has stabilized.

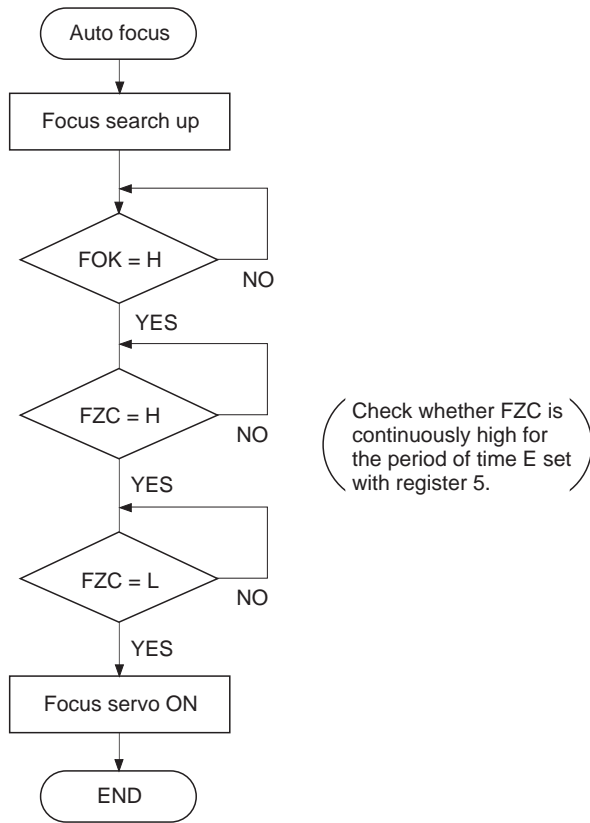

Fig. 4-6-(a). Auto Focus Flow Chart

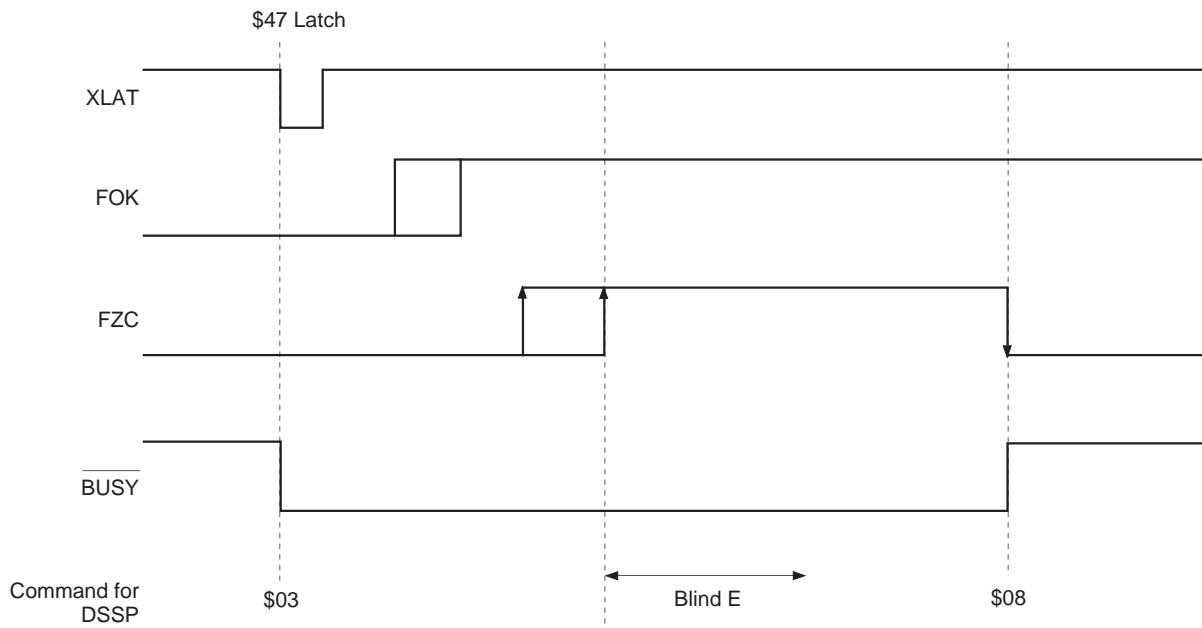

Fig. 4-6-(b). Auto Focus Timing Chart



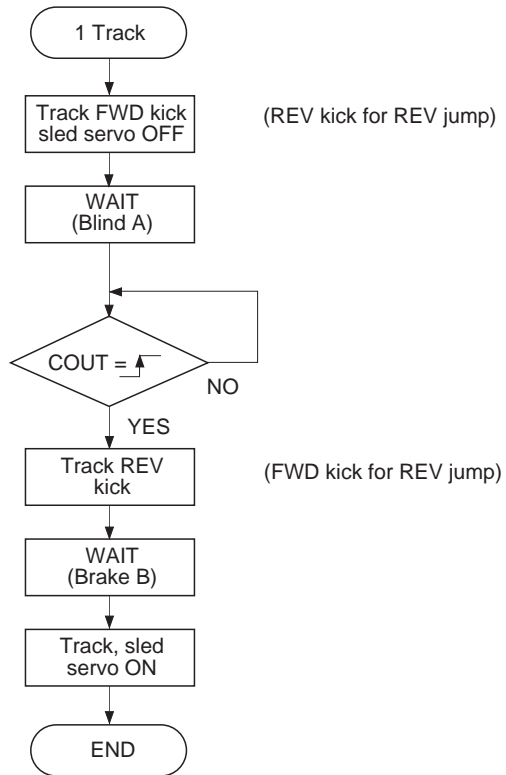

Fig. 4-7-(a). 1-Track Jump Flow Chart

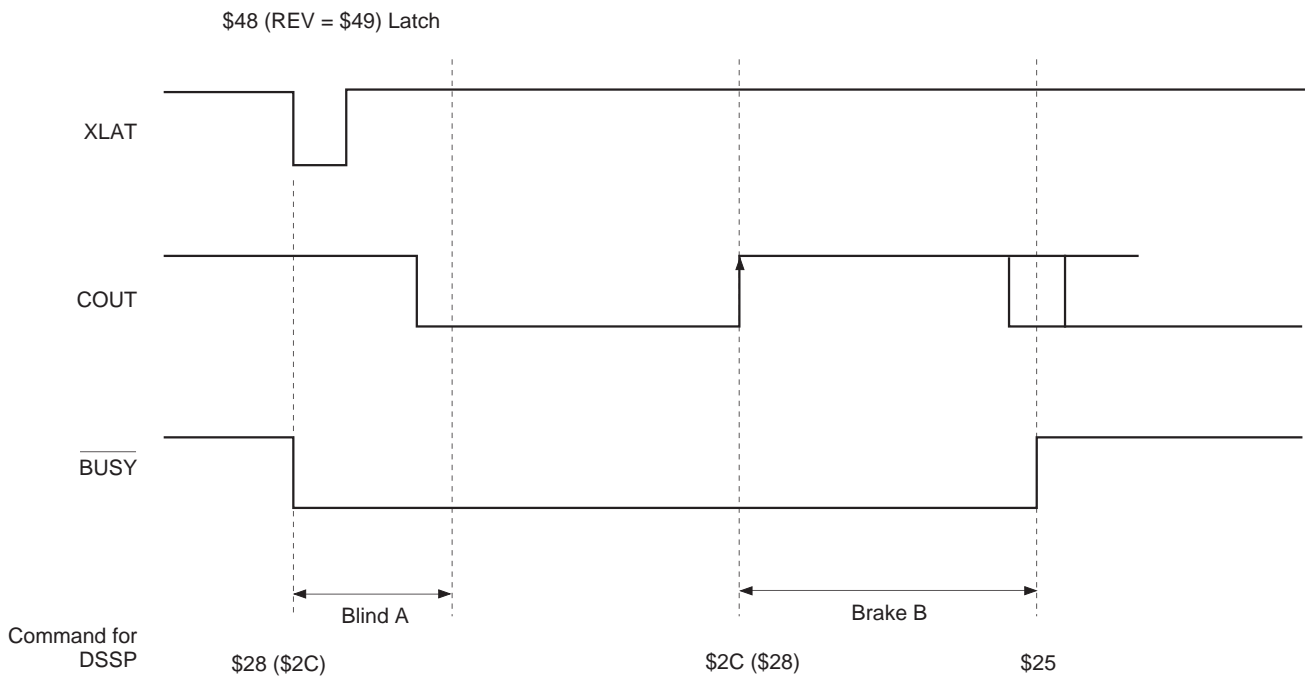

Fig. 4-7-(b). 1-Track Jump Timing Chart

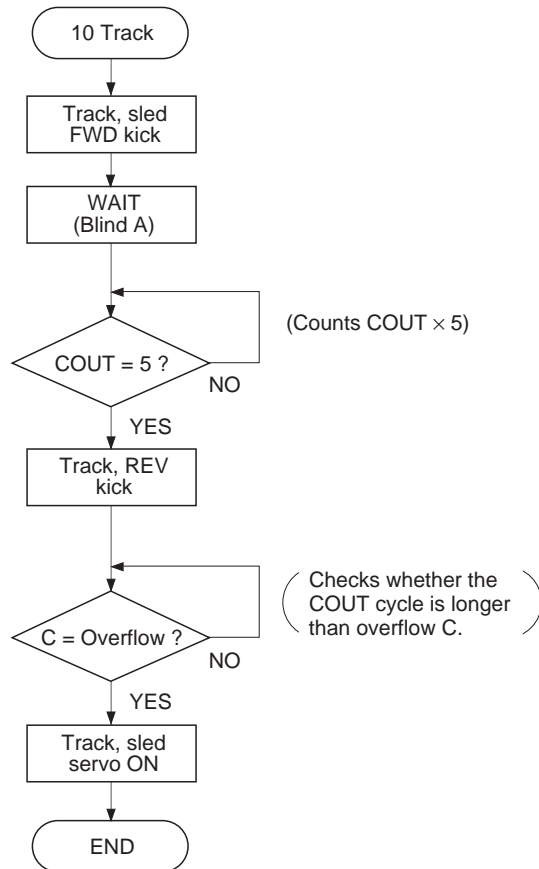

Fig. 4-8-(a). 10-Track Jump Flow Chart

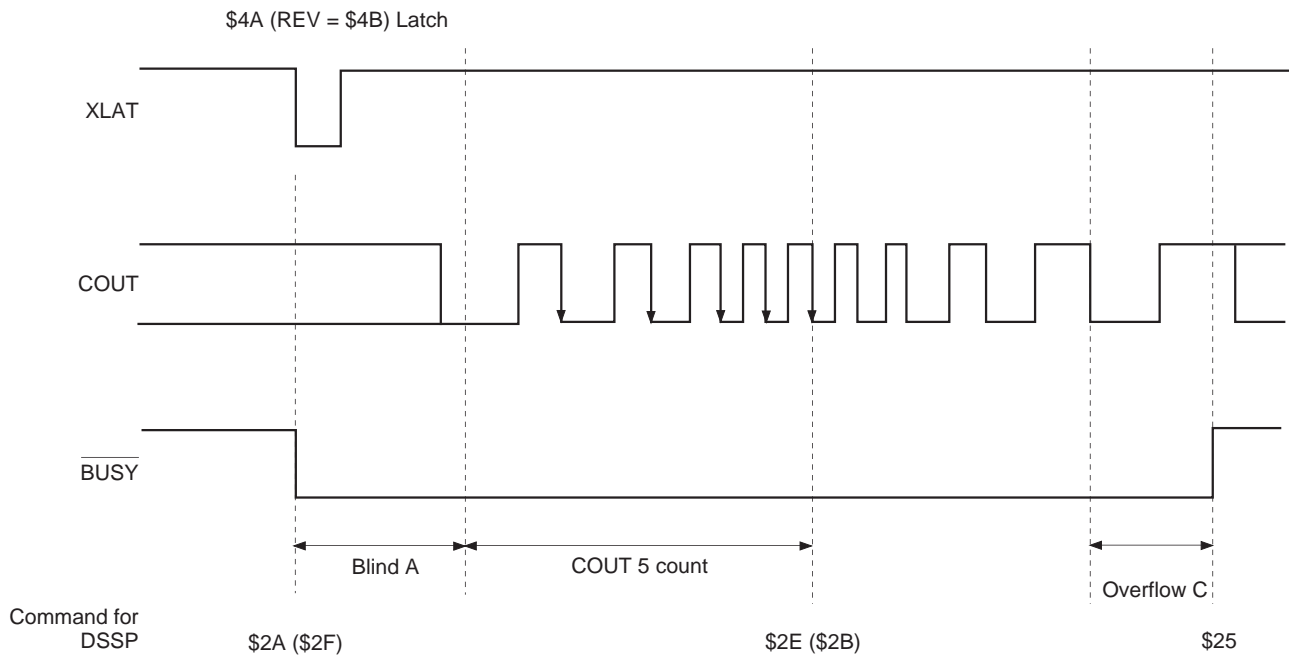

Fig. 4-8-(b). 10-Track Jump Timing Chart

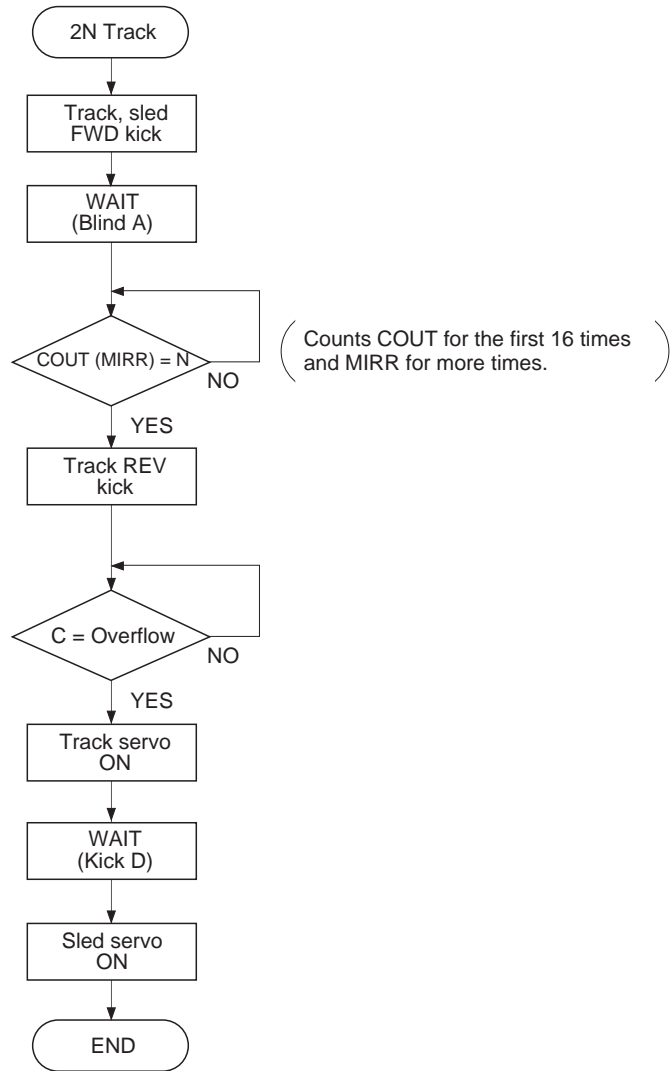

Fig. 4-9-(a). 2N-Track Jump Flow Chart

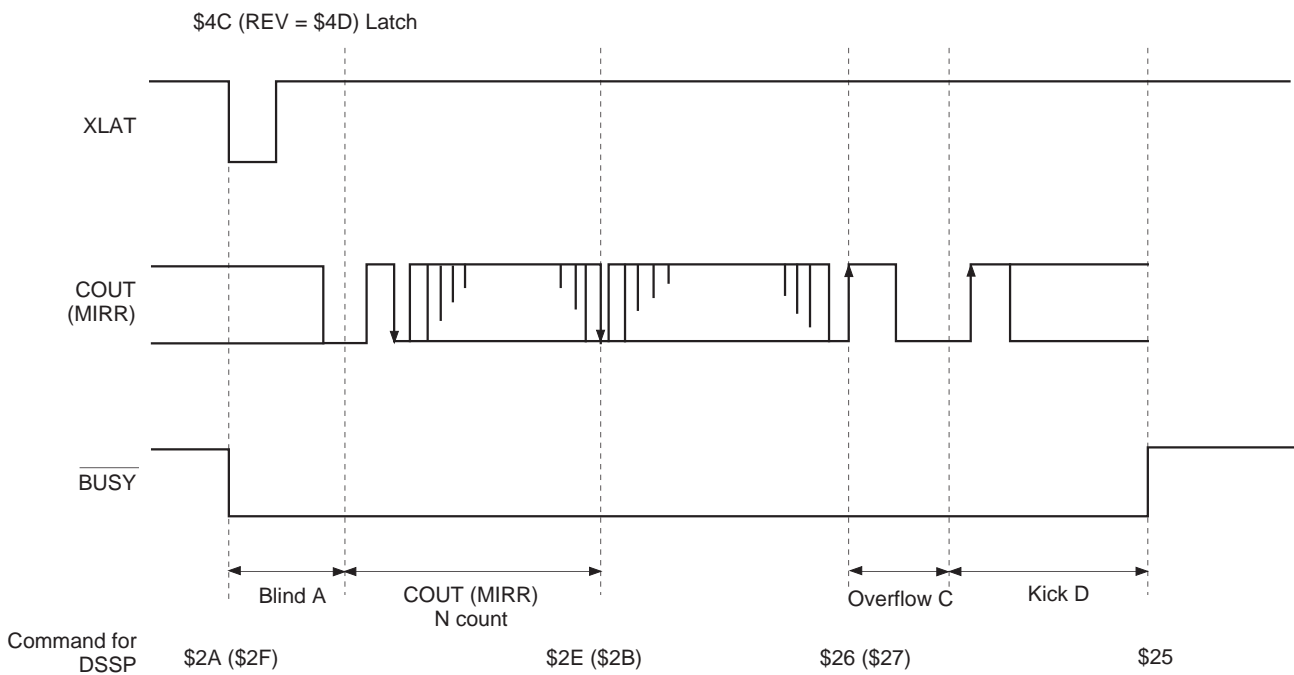

Fig. 4-9-(b). 2N-Track Jump Timing Chart

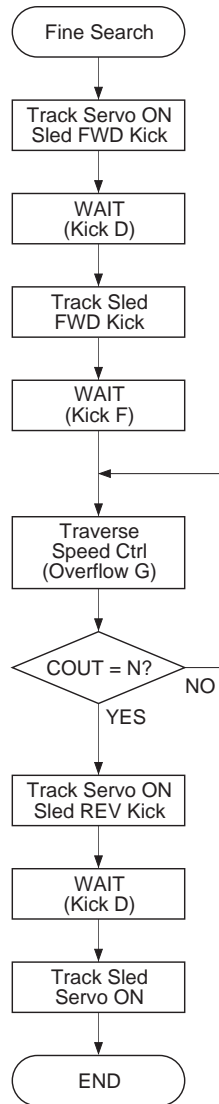

Fig. 4-10-(a). Fine Search Flow Chart

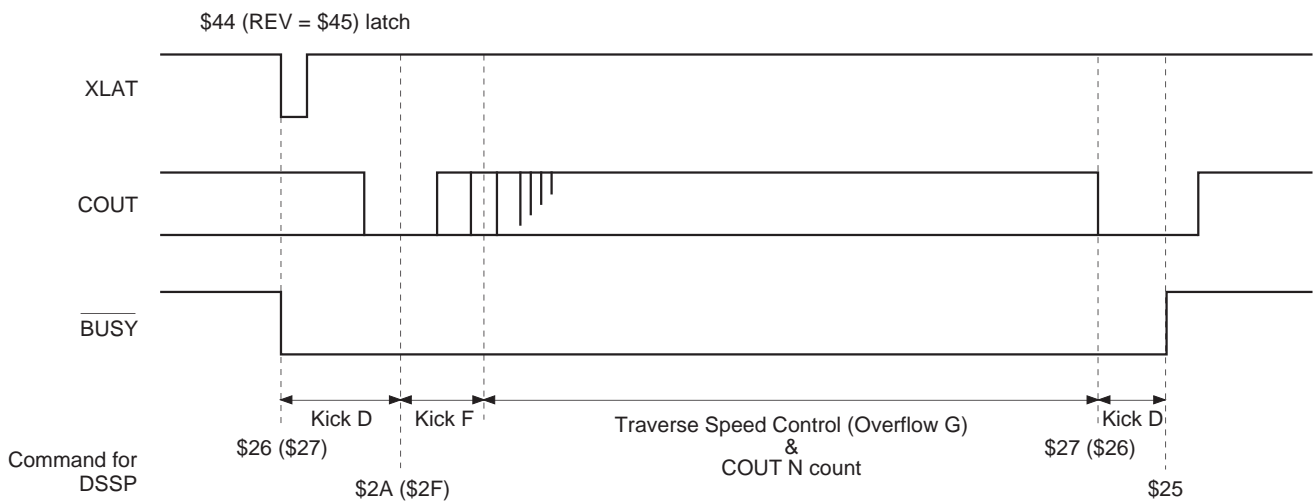

Fig. 4-10-(b). Fine Search Timing Chart

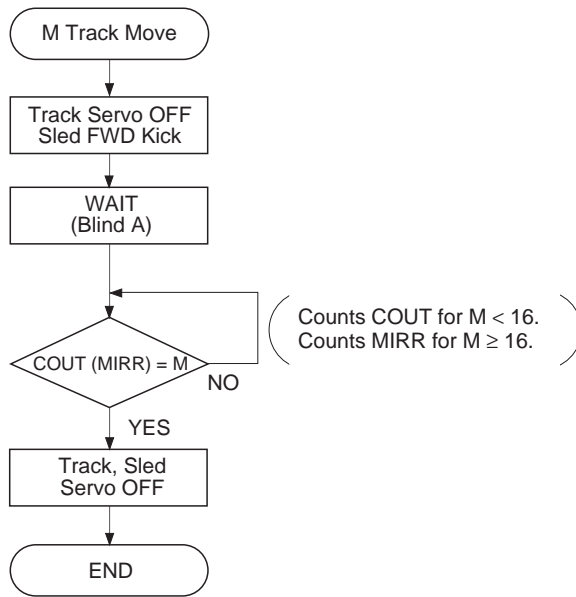

Fig. 4-11-(a). M-Track Move Flow Chart

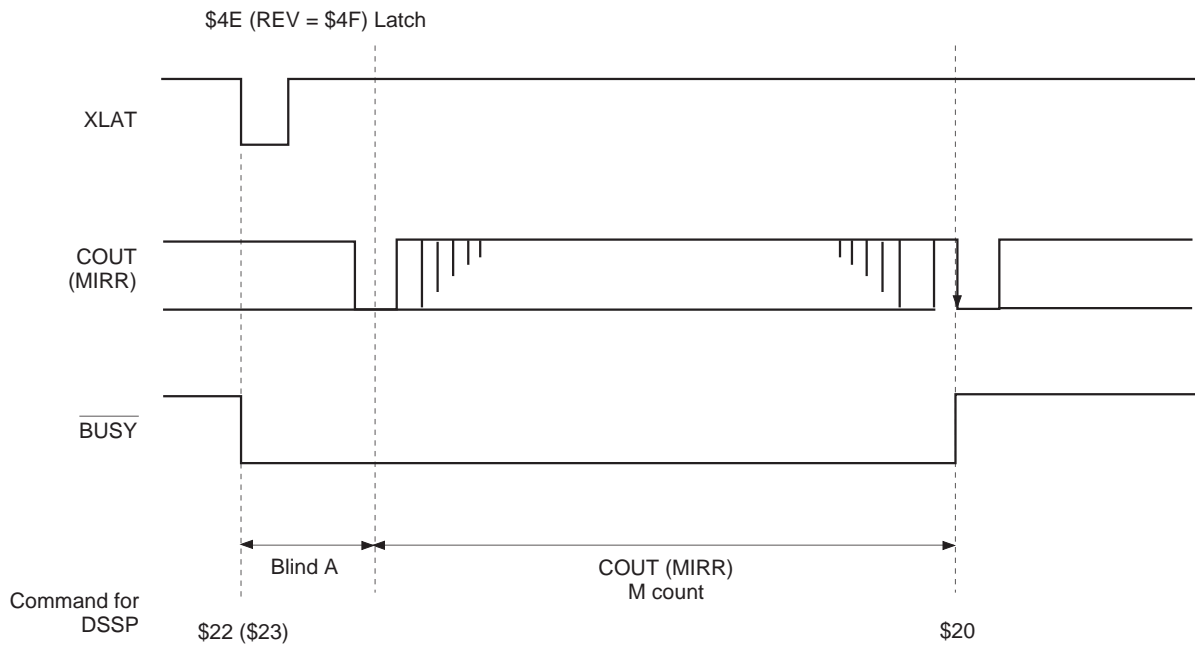
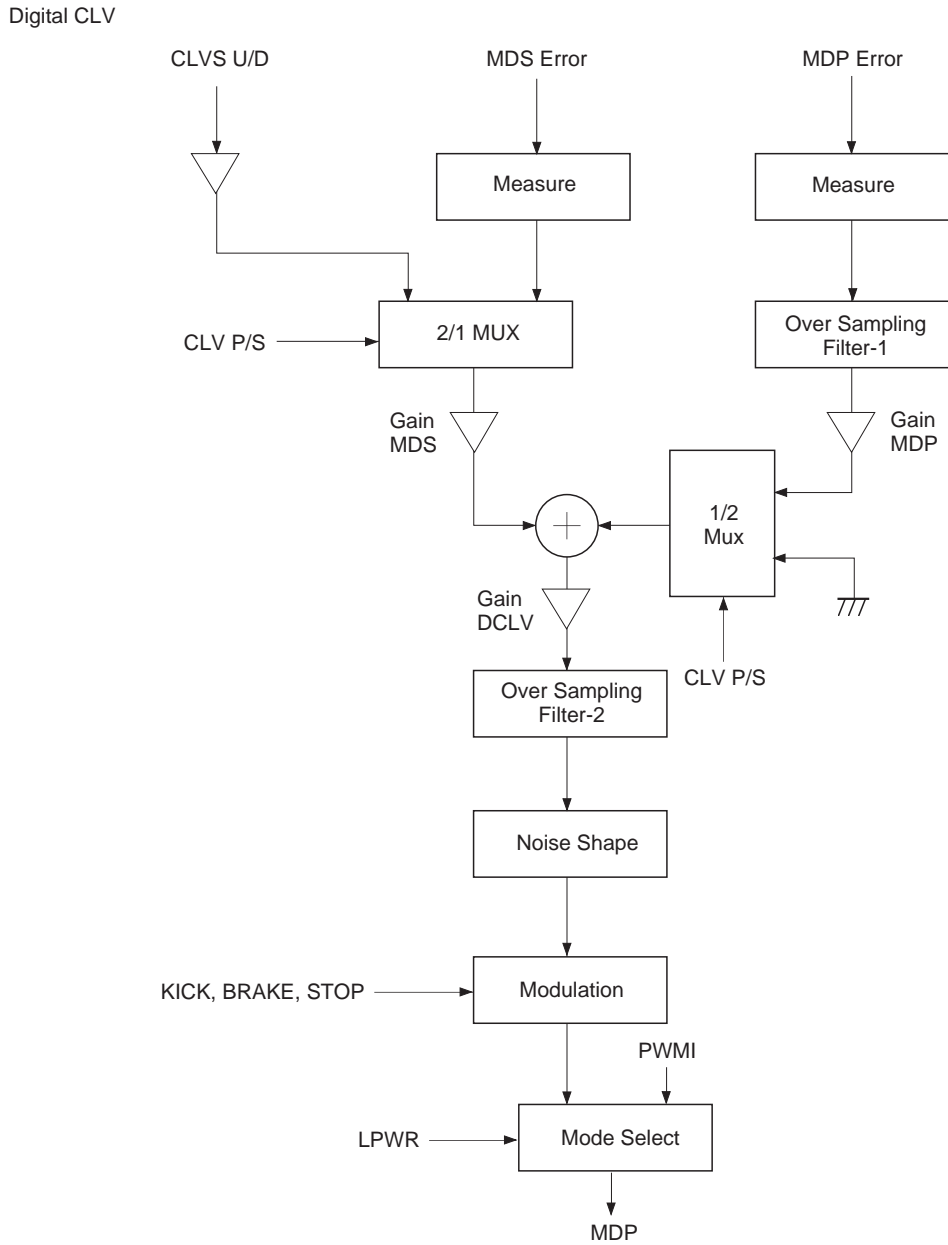

Fig. 4-11-(b). M-Track Move Timing Chart

§ 4-7. Digital CLV

Fig. 4-12 shows the block diagram. Digital CLV outputs MDS error and MDP error signals with PWM, with the sampling frequency increased up to 130kHz during normal-speed playback in CLVS, CLVP and other modes. In addition, the digital spindle servo gain is variable.



- CLVS U/D: Up/down signal from CLVS servo
- MDS error: Frequency error for CLVP servo
- MDP error: Phase error for CLVP servo
- PWMI: Spindle drive signal from the microcomputer for CAV servo

Fig. 4-12. Block Diagram

#### § 4-8. Playback Speed

In the CXD2585Q, the following playback modes can be selected through different combinations of XTAI, XTSL pin, double-speed command (DSPB), VCO1 selection command (VCOSEL1), VCO1 frequency division commands (KSL3, KSL2) and command transfer rate selector (ASHS) in CLV-N or CLV-W mode.

Mode	XTAI	XTSL	DSPB	VCOSEL1*1	ASHS	Playback speed	Error correction*2
1	768Fs	1	0	0/1	0	1×	C1: double; C2: quadruple
2	768Fs	1	1	0/1	0	2×	C1: double; C2: double
3	768Fs	0	0	1	1	2×	C1: double; C2: quadruple
4	768Fs	0	1	1	1	4×	C1: double; C2: double
5	384Fs	0	0	0/1	0	1×	C1: double; C2: quadruple
6	384Fs	0	1	0/1	0	2×	C1: double; C2: double
7	384Fs	1	1	0/1	0	1×	C1: double; C2: double

\*1 Actually, the optimal value should be used together with KSL3 and KSL2.

\*2 When \$8 ERC4 = 1, C2 is for quadruple correction with DSPB = 1.

The playback speed can be varied by setting VP0 to VP7 in CAV-W mode. See "[3] Description of Modes" for details.

§ 4-9. Asymmetry Correction

Fig. 4-13 shows the block diagram and circuit example.

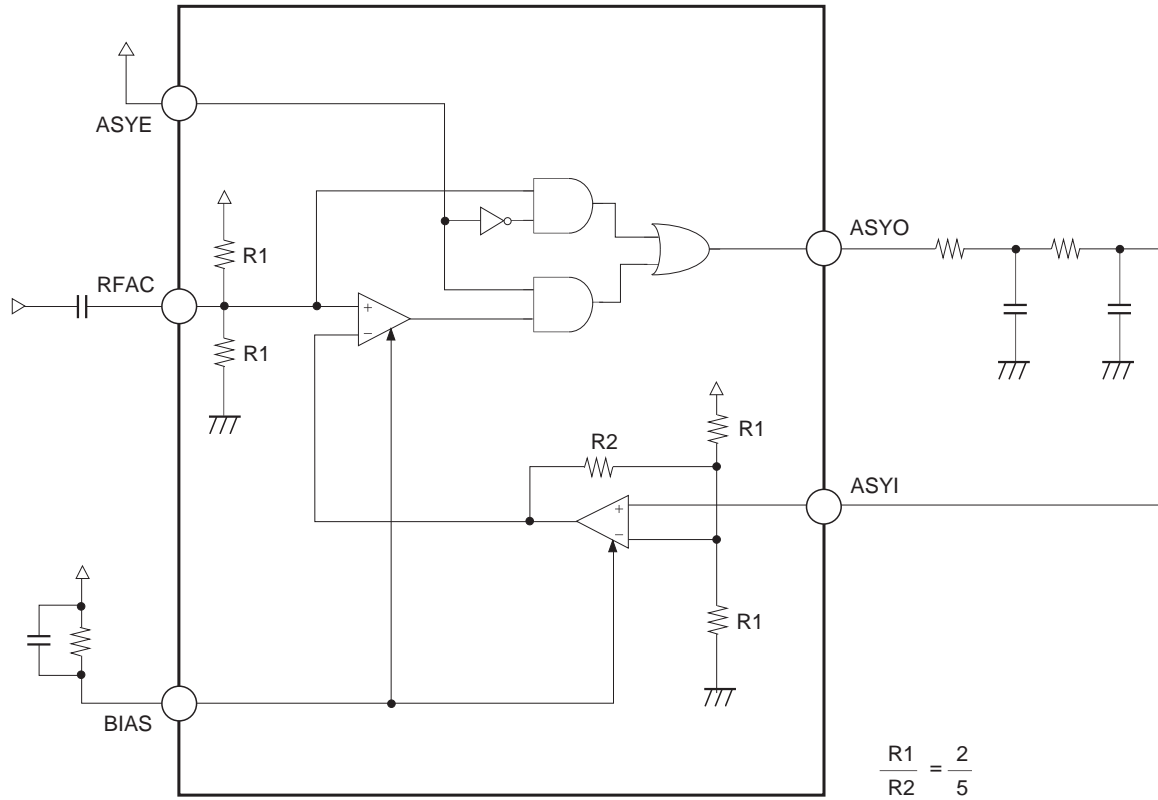

Fig. 4-15. Asymmetry Correction Application Circuit



#### §4-10. CD TEXT Data Demodulation

- In order to demodulate the CD TEXT data, set the command \$8 Data 6 D3 TXON to 1. During TXON = 1, connect EXCK to low and do not use the data output from SBSO because the CD TEXT demodulation circuit uses EXCK and the SBSO pin exclusively.

It requires 26.7ms (max.) to demodulate the CD TEXT data correctly after TXON is set to 1.

- The CD TEXT data is output by switching the SQSO pin with the command. The CD TEXT data output is enabled by setting the command \$8 Data 6 D2 TXOUT to 1. To read data, the readout clock should be input to SQCK.
- The readable data are the CRC counting results for the each pack and the CD TEXT data (16 bytes) except for CRC data.
- When the CD TEXT data is read, the order of the MSB and LSB is inverted within each byte. As a result, although the sequence of the bytes is the same, the bits within the bytes are now ordered LSB first.
- Data which can be stored in the LSI is 1 packet (4 packs).

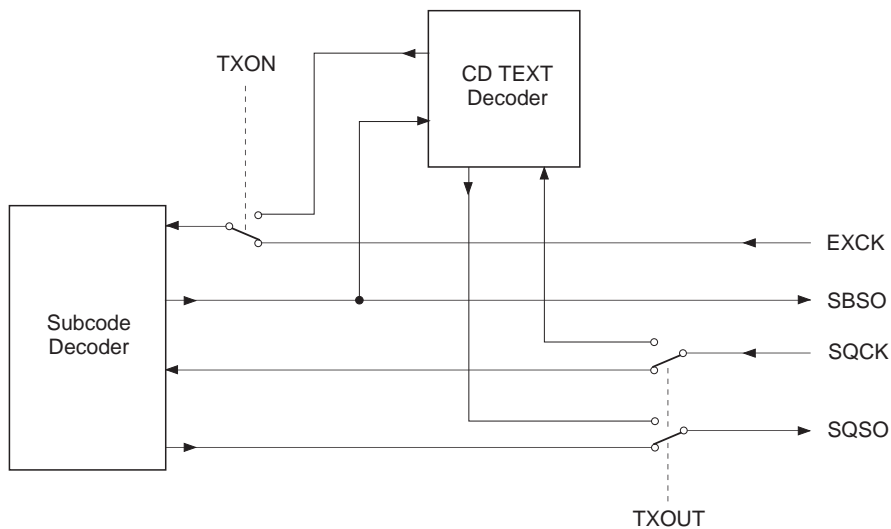

Fig. 4-14. Block Diagram of CD TEXT Demodulation Circuit

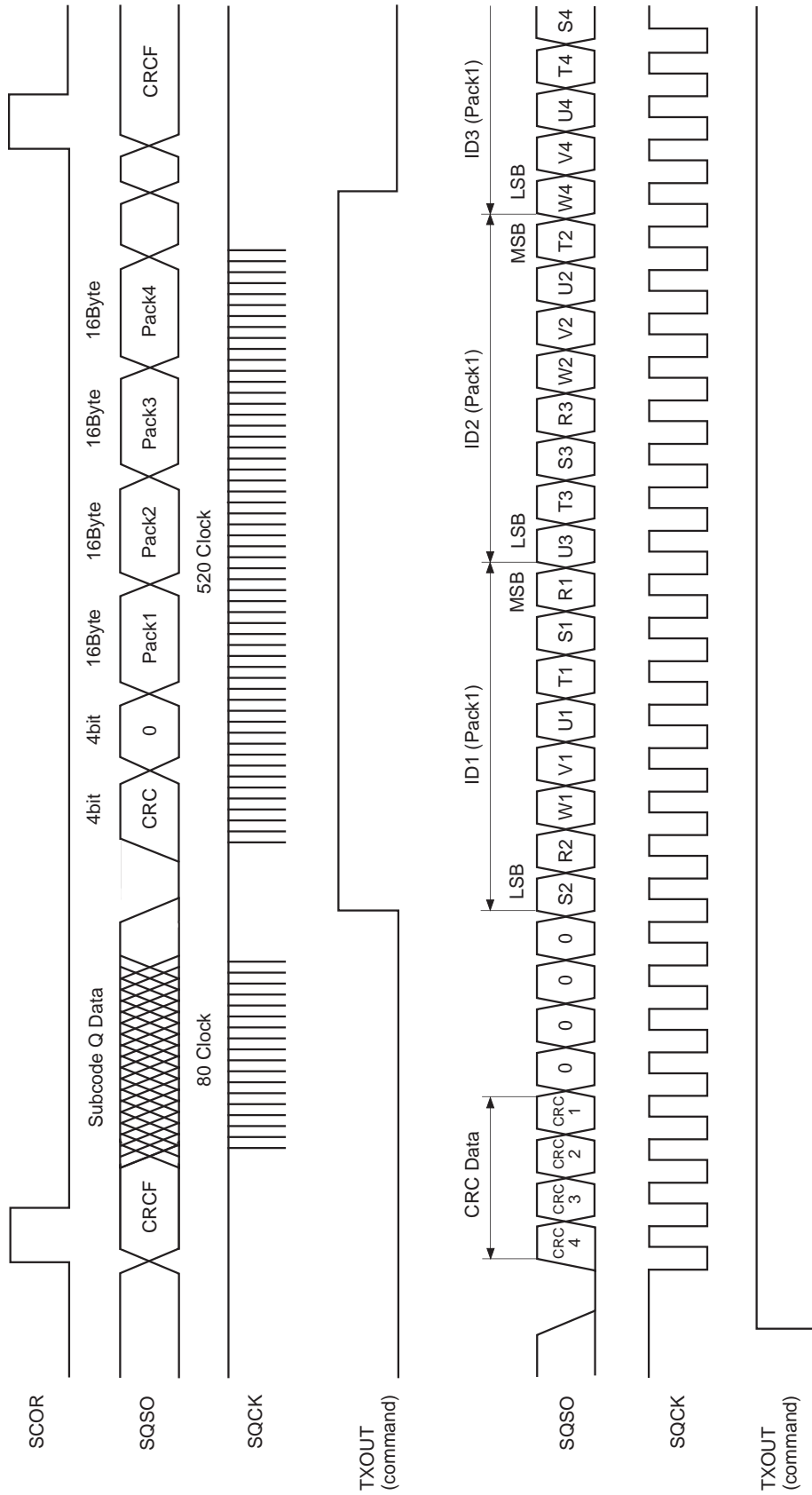

Fig. 4-15. CD TEXT Data Timing Chart

## [5] Description of Servo Signal Processing System Functions and Commands

### §5-1. General Description of Servo Signal Processing System ( $V_{DD}$ : Supply voltage)

#### Focus servo

Sampling rate:	88.2kHz (when MCK = 128Fs)
Input range:	0.3V <sub>DD</sub> to 0.7V <sub>DD</sub>
Output format:	7-bit PWM
Other:	Offset cancel Focus bias adjustment Focus search Gain-down function Defect countermeasure Auto gain control

#### Tracking servo

Sampling rate:	88.2kHz (when MCK = 128Fs)
Input range:	0.3V <sub>DD</sub> to 0.7V <sub>DD</sub>
Output format:	7-bit PWM
Other:	Offset cancel E:F balance adjustment Track jump Gain-up function Defect countermeasure Drive cancel Auto gain control Vibration countermeasure

#### Sled servo

Sampling rate:	345Hz (when MCK = 128Fs)
Input range:	0.3V <sub>DD</sub> to 0.7V <sub>DD</sub>
Output format:	7-bit PWM
Other:	Sled move

#### FOK, MIRR, DFCT signal generation

RF signal sampling rate:	1.4MHz (when MCK = 128Fs)
Input range:	0.43V <sub>DD</sub> to V <sub>DD</sub>
Other:	RF zero level automatic measurement

### §5-2. Digital Servo Block Master Clock (MCK)

The clock with the 2/3 frequency of the crystal is supplied to the digital servo block.

XT4D and XT2D are \$3F commands, and XT1D is \$3E command. (Default = 0)

The digital servo block is designed with an MCK frequency of 5.6448MHz (128Fs) as typical.

Mode	XTAI	FSTO	XTSL	XT4D	XT2D	XT1D	Frequency division ratio	MCK
1	384Fs	256Fs	*	*	*	1	1	256Fs
2	384Fs	256Fs	*	*	1	0	1/2	128Fs
3	384Fs	256Fs	0	0	0	0	1/2	128Fs
4	768Fs	512Fs	*	*	*	1	1	512Fs
5	768Fs	512Fs	*	*	1	0	1/2	256Fs
6	768Fs	512Fs	*	1	0	0	1/4	128Fs
7	768Fs	512Fs	1	0	0	0	1/4	128Fs

Fs = 44.1kHz, \*: Don't care

Table 5-1.

### § 5-3. DC Offset Cancel [AVRG (Average) Measurement and Compensation] (See Fig. 5-3.)

The CXD2585Q can measure the average of RFDC, VC, FE and TE and compensate these signals using the measurement results to control the servo effectively. This AVRG measurement and compensation is necessary to initialize the CXD2585Q, and is able to cancel the DC offset.

AVRG measurement takes the levels applied to the VC, FE, RFDC and TE pins as the digital average of 256 samples, and then loads these values into each AVRG register.

The AVRG measurement commands are D15 (VCLM), D13 (FLM), D11 (RFLM) and D4 (TLM) of \$38.

Measurement is on when the respective command is set to 1.

AVRG measurement requires approximately 2.9ms to 5.8ms (when MCK = 128Fs) after the command is received.

The completion of AVRG measurement operation can be monitored by the SENS pin. (See Timing Chart 5-2.)

Monitoring requires that the upper 8 bits of the command register are 38 (Hex).

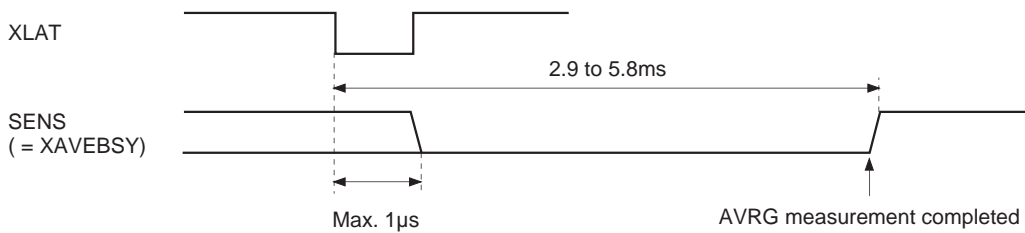

Timing Chart 5-2.

#### <Measurement>

VC AVRG: The VC DC offset (VC AVRG) which is the center voltage for the system is measured and used to compensate the FE, TE and SE signals.

FE AVRG: The FE DC offset (FE AVRG) is measured and used to compensate the FE and FZC signals.

TE AVRG: The TE DC offset (TE AVRG) is measured and used to compensate the TE and SE signals.

RF AVRG: The RF DC offset (RF AVRG) is measured and used to compensate the RFDC signal.

#### <Compensation>

RFLC: (RF signal – RF AVRG) is input to the RF In register.

"00" is input when the RF signal is lower than RF AVRG.

TLC0: (TE signal – VC AVRG) is input to the TRK In register.

TLC1: (TE signal – TE AVRG) is input to the TRK In register.

VCLC: (FE signal – VC AVRG) is input to the FCS In register.

FLC1: (FE signal – FE AVRG) is input to the FCS In register.

FLC0: (FE signal – FE AVRG) is input to the FZC register.

Two methods of canceling the DC offset are assumed for the CXD2585Q. These methods are shown in Figs. 5-3a and 5-3b.

An example of AVRG measurement and compensation commands is shown below.

\$38 08 00 (RF AVRG measurement)

\$38 20 00 (FE AVRG measurement)

\$38 00 10 (TE AVRG measurement)

\$38 14 0A (Compensation on [RFLC, FLC0, FLC1, TLC1], corresponds to Fig. 5-3a.)

See the description of \$38 for these commands.

#### § 5-4. E:F Balance Adjustment Function (See Fig. 5-3.)

When the disc is rotated with the laser on, and with the FCS (focus) servo on via FCS Search (focus search), the traverse waveform appears in the TE signal due to disc eccentricity.

In this condition, the low-frequency component can be extracted from the TE signal using the built-in TRK hold filter by setting D5 (TBLM) of \$38 to 1.

The extracted low-frequency component is loaded into the TRVSC register as a digital value, and the TRVSC register value is established when TBLM returns to "0".

Next, setting D2 (TLC2) of \$38 to 1 compensates the values obtained from the TE and SE input pins with the TRVSC register value (subtraction), allowing the E:F balance offset to be adjusted. (See Fig. 5-3.)

#### § 5-5. FCS Bias (Focus Bias) Adjustment Function

The FBIAS register value can be added to the FCS servo filter input by setting D14 (FBON) of \$3A to 1. (See Fig. 5-3.)

When D11 = 0 and D10 = 1 is set by \$34F, the FBIAS register value can be written using the 9-bit value of D9 to D1 (D9: MSB).

In addition, the RF jitter can be monitored by setting the \$8 command SOCT to 1. (See "DSP Block Timing Chart".)

The FBIAS register can be used as a counter by setting D13 (FBSS) of \$3A to 1. The FBIAS register functions as an up counter when D12 (FBUP) of \$3A = 1, and as a down counter when D12 (FBUP) of \$3A = 0.

The number of up and down steps can be changed by setting D11 and D10 (FBV1 and FBV0) of \$3A.

When using the FBIAS register as a counter, the counter stops when the value set beforehand in FBL9 to FBL1 of \$34 matches the FCSBIAS value. Also, if the upper 8 bits of the command register are \$3A at this time, SENS goes to high and the counter stop can be monitored.

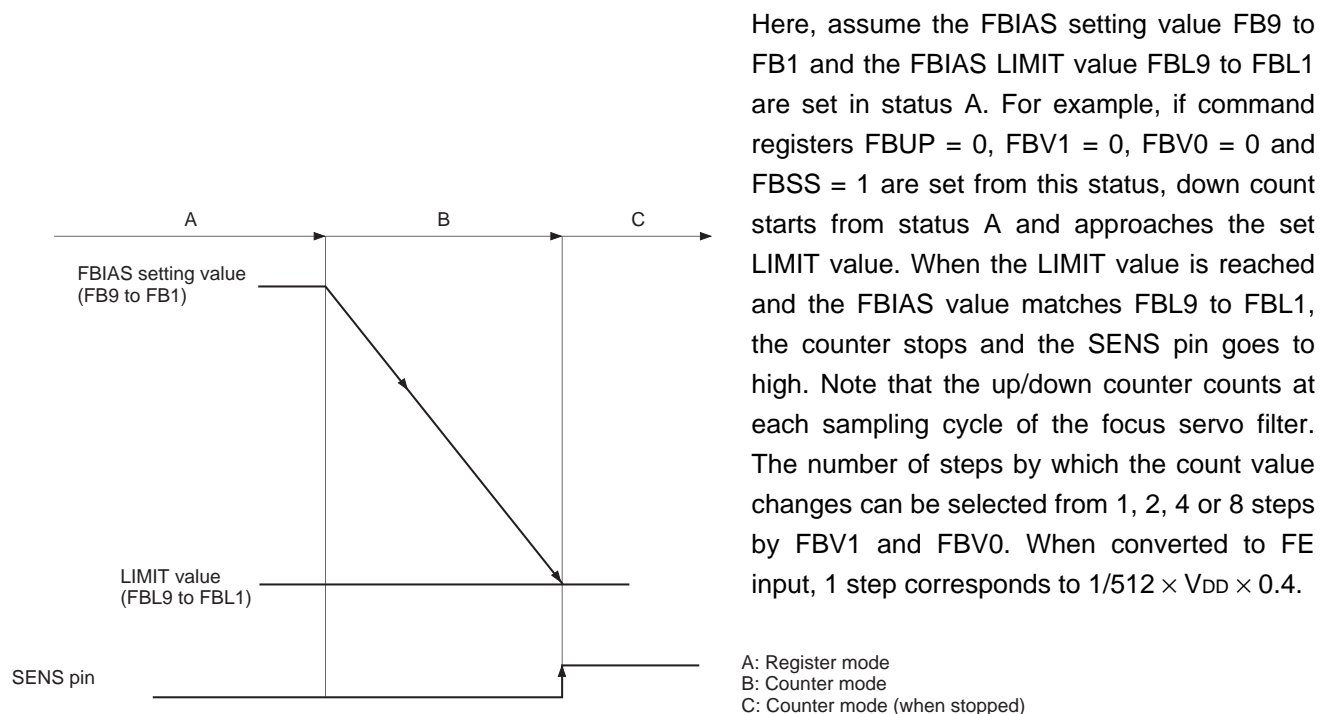

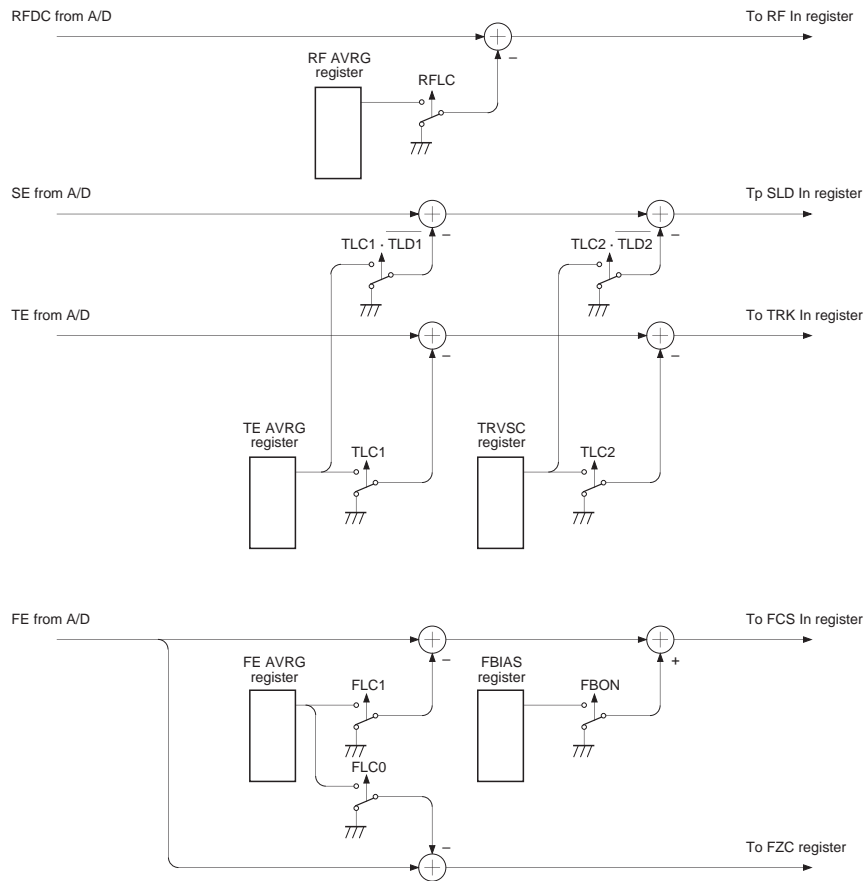

Fig. 5-3a.

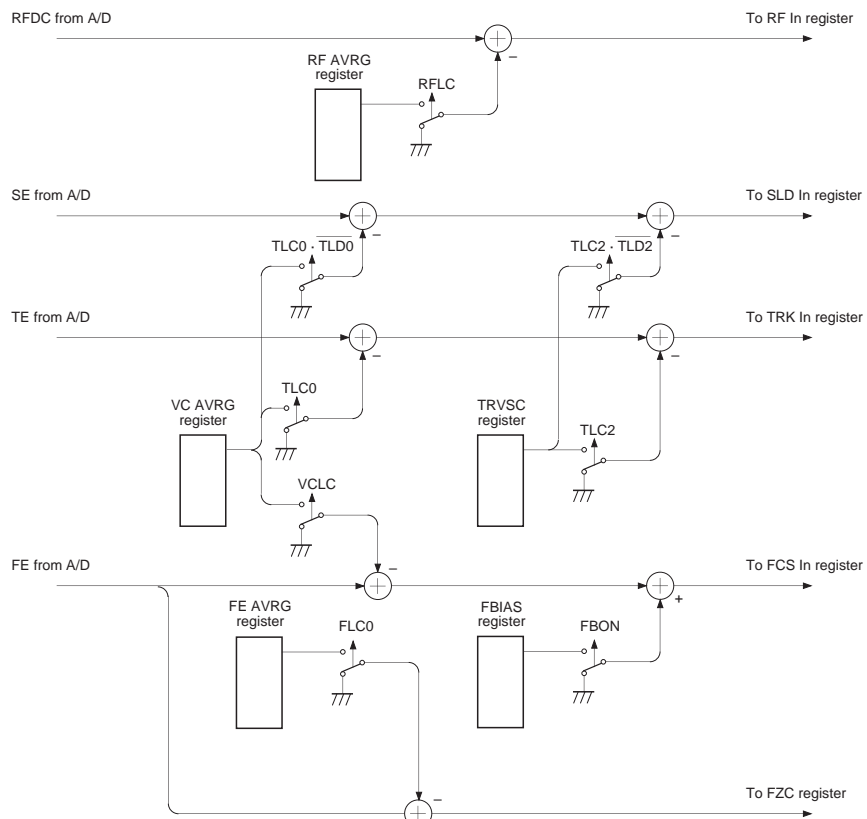

Fig. 5-3b.

### § 5-6. AGCNTL (Automatic Gain Control) Function

The AGCNTL function automatically adjusts the filter internal gain in order to obtain the appropriate servo loop gain. AGCNTL not only copes with the sensitivity variation of the actuator and photo diode, etc., but also obtains the optimal gain for each disc.

The AGCNTL command is sent when each servo is turned on. During AGCNTL operation, if the upper 8 bits of the command register are 38 (Hex), the completion of AGCNTL operation can be confirmed by monitoring the SENS pin. (See Timing Chart 5-4 and "Description of SENS Signals".)

Setting D9 and D8 of \$38 to 1 set FCS (focus) and TRK (tracking) respectively to AGCNTL operation.

**Note)** During AGCNTL operation, each servo filter gain must be normal, and the anti-shock circuit (described hereafter) must be disabled.

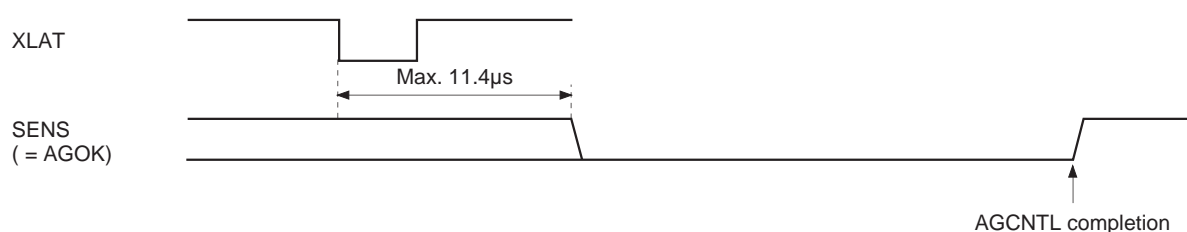

Timing Chart 5-4.

Coefficient K13 changes for AGF (focus AGCNTL) and coefficients K23 and K07 change for AGT (tracking AGCNTL) due to AGCNTL.

These coefficients change from 01 to 7F (Hex), and they must also be set within this range when written externally.

After AGCNTL operation has completed, these coefficient values can be confirmed by reading them out from the SENS pin with the serial readout function (described hereafter).

#### AGCNTL related settings

The following settings can be changed with \$35, \$36 and \$37.

FG6 to FG0; AGF convergence gain setting, effective setting range: 00 to 57 (Hex)

TG6 to TG0; AGT convergence gain setting, effective setting range: 00 to 57 (Hex)

AGS; Self-stop on/off

AGJ; Convergence completion judgment time

AGGF; Internally generated sine wave amplitude (AGF)

AGGT; Internally generated sine wave amplitude (AGT)

AGV1; AGCNTL sensitivity 1 (during rough adjustment)

AGV2; AGCNTL sensitivity 2 (during fine adjustment)

AGHS; Rough adjustment on/off

AGHT; Fine adjustment time

**Note)** Converging servo loop gain values can be changed with the FG6 to FG0 and TG6 to TG0 setting values. In addition, these setting values must be within the effective setting range. The default settings aim for 0dB at 1kHz. However, since convergence values vary according to the characteristics of each constituent element of the servo loop, FG and TG values should be set as necessary.



AGCNTL and default operation have two stages.

In the first stage, rough adjustment is performed with high sensitivity for a certain period of time (select 256/128ms with AGHT, when MCK = 128Fs), and the AGCNTL coefficient approaches the appropriate value. The sensitivity at this time can be selected from two types with AGV1.

In the second stage, the AGCNTL coefficient is finely adjusted with relatively low sensitivity to further approach the appropriate value. The sensitivity for the second stage can be selected from two types with AGV2. In the second stage of default operation, when the AGCNTL coefficient reaches the appropriate value and stops changing, the CXD2585Q confirms that the AGCNTL coefficient has not changed for a certain period of time (select 63/31ms with AGHJ, when MCK = 128Fs), and then completes AGCNTL operation. (Self stop mode)

This self-stop mode can be canceled by setting AGS to 0.

In addition, the first stage is omitted for AGCNTL operation when AGHS is set to 0.

An example of AGCNTL coefficient transitions during AGCNTL operation with various settings is shown in Fig. 5-5.

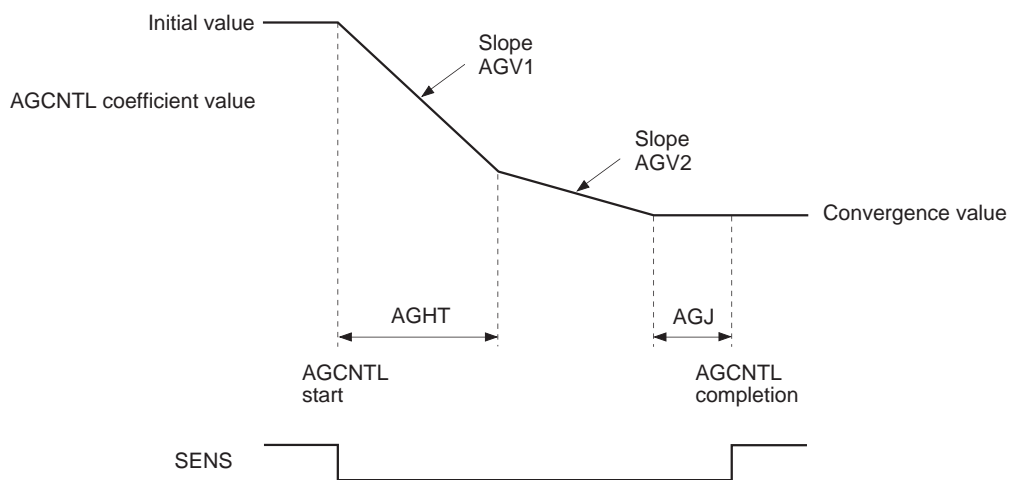

Fig. 5-5.

**Note)** Fig. 5-5 shows the case where the AGCNTL coefficient converges from the initial value to a smaller value.

**§ 5-7. FCS Servo and FCS Search (Focus Search)**

The FCS servo is controlled by the 8-bit serial command \$0X. (See Table 5-6.)

Register name	Command	D23 to D20	D19 to D16	
0	FOCUS CONTROL	0 0 0 0	1 0 * *	FOCUS SERVO ON (FOCUS GAIN NORMAL)
			1 1 * *	FOCUS SERVO ON (FOCUS GAIN DOWN)
			0 * 0 *	FOCUS SERVO OFF, 0V OUT
			0 * 1 *	FOCUS SERVO OFF, FOCUS SEARCH VOLTAGE OUT
			0 * 1 0	FOCUS SEARCH VOLTAGE DOWN
			0 * 1 1	FOCUS SEARCH VOLTAGE UP

**Table 5-6.**

\*: Don't care

**FCS Search**

FCS search is required in the course of turning on the FCS servo.

Fig. 5-7 shows the signals for sending commands \$00 → \$02 → \$03 and performing only FCS search operation.

Fig. 5-8 shows the signals for sending \$08 (FCS on) after that.

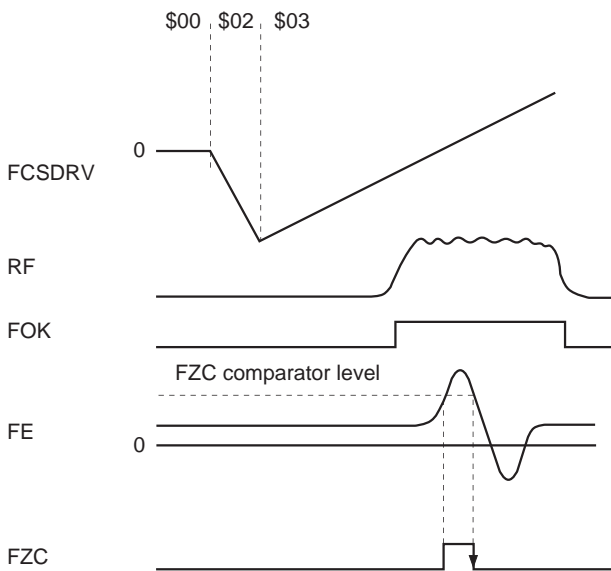

**Fig. 5-7.**

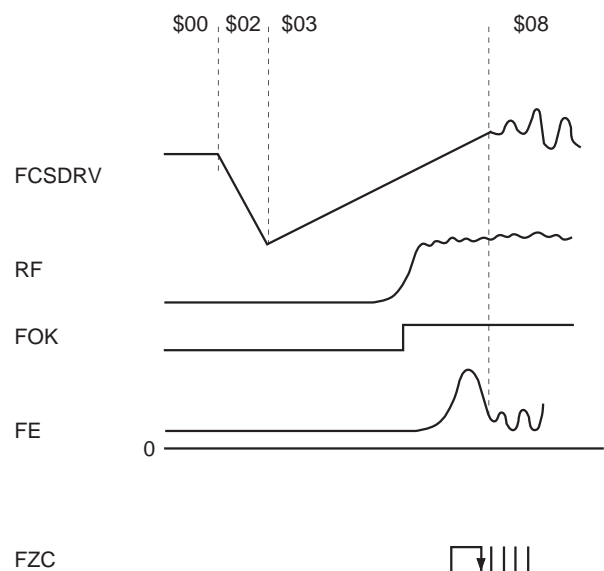

**Fig. 5-8.**

### § 5-8. TRK (Tracking) and SLD (Sled) Servo Control

The TRK and SLD servos are controlled by the 8-bit command \$2X. (See Table 5-9.)

When the upper 4 bits of the serial data are 2 (Hex), TZC is output to the SENS pin.

Register name	Command	D23 to D20	D19 to D16	
2	TRACKING MODE	0 0 1 0	0 0 * *	TRACKING SERVO OFF
			0 1 * *	TRACKING SERVO ON
			1 0 * *	FORWARD TRACK JUMP
			1 1 * *	REVERSE TRACK JUMP
			* * 0 0	SLED SERVO OFF
			* * 0 1	SLED SERVO ON
			* * 1 0	FORWARD SLED MOVE
			* * 1 1	REVERSE SLED MOVE

Table 5-9.

\*: Don't care

#### TRK Servo

The TRK JUMP (track jump) level can be set with 6 bits (D13 to D8) of \$36.

In addition, when the TRK servo is on and D17 of \$1 is set to 1, the TRK servo filter switches to gain-up mode. The filter also switches to gain-up mode when the LOCK signal goes low or when vibration is detected with the anti-shock circuit (described hereafter) enabled.

The CXD2585Q has 2 types of gain-up filter structures in TRK gain-up mode which can be selected by setting D16 of \$1. (See Table 5-17.)

#### SLD Servo

The SLD MOV (sled move) output, composed of a basic value from 6 bits (D13 to D8) of \$37, is determined by multiplying this value by 1×, 2×, 3×, or 4× magnification set using D17 and D16 when D18 = D19 = 0 is set with \$3. (See Table 5-10.)

SLD MOV must be performed continuously for 50μs or more. In addition, if the LOCK input signal goes low when the SLD servo is on, the SLD servo turns off.

**Note)** When the LOCK signal is low, the TRK servo switches to gain-up mode and the SLD servo is turned off.

These operations are disabled by setting D6 (LKSW) of \$38 to 1.

Register name	Command	D23 to D20	D19 to D16	
3	SELECT	0 0 1 1	0 0 0 0	SLED KICK LEVEL (basic value × ±1)
			0 0 0 1	SLED KICK LEVEL (basic value × ±2)
			0 0 1 0	SLED KICK LEVEL (basic value × ±3)
			0 0 1 1	SLED KICK LEVEL (basic value × ±4)

Table 5-10.

**§ 5-9. MIRR and DFCT Signal Generation**

The RF signal obtained from the RFDC pin is sampled at approximately 1.4MHz (when MCK = 128Fs) and loaded. The MIRR and DFCT signals are generated from this RF signal.

**MIRR Signal Generation**

The loaded RF signal is applied to peak hold and bottom hold circuits.

An envelope is generated from the waveforms generated in these circuits, and the MIRR comparator level is generated from the average of this envelope waveform.

The MIRR signal is generated by comparing the waveform generated by subtracting the bottom hold value from the peak hold value with this MIRR comparator level. (See Fig. 5-11.)

The bottom hold speed and mirror sensitivity can be selected from 4 values using D7 and D6, and D5 and D4, respectively, of \$3C.

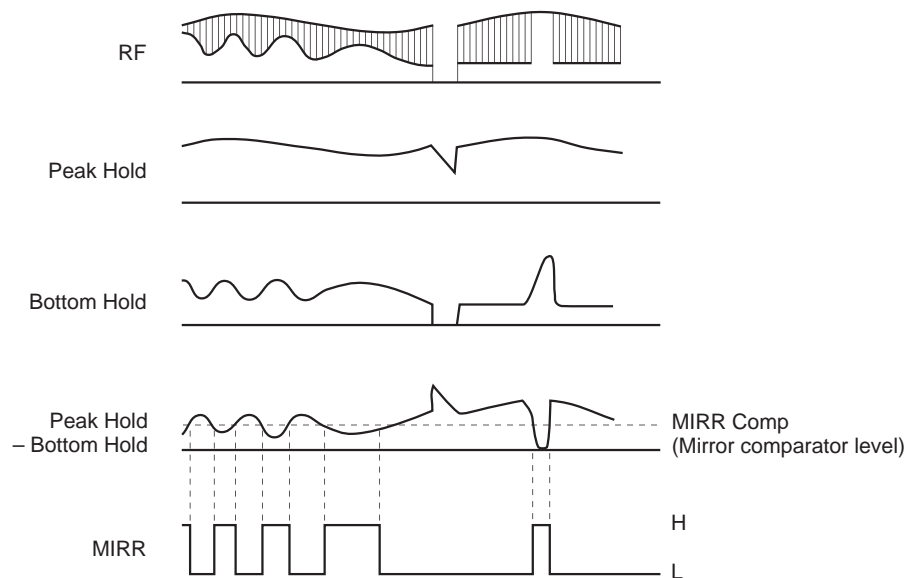
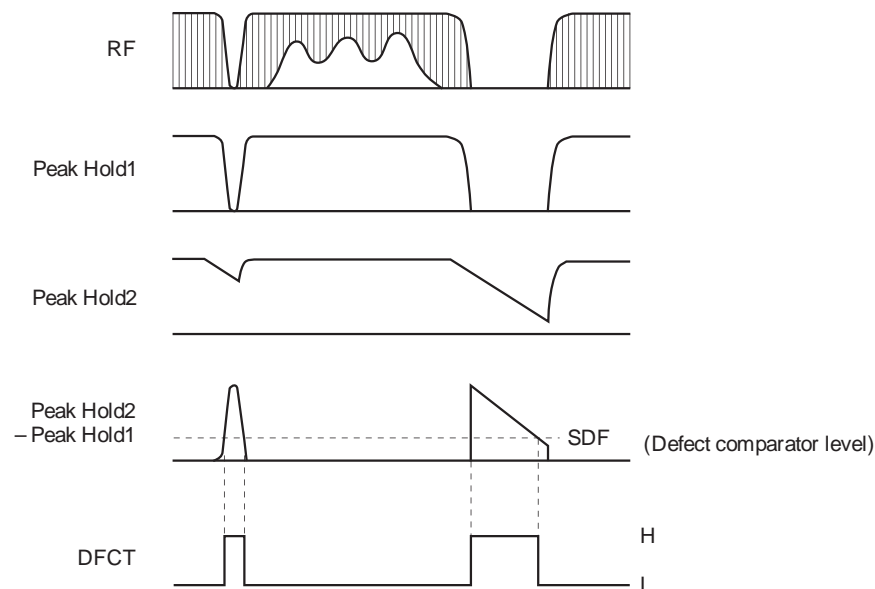

**Fig. 5-11.**

**DFCT Signal Generation**

The loaded RF signal is input to two peak hold circuits with different time constants, and the DFCT signal is generated by comparing the difference between these two peak hold waveforms with the DFCT comparator level. (See Fig. 5-12.)

The DFCT comparator level can be selected from four values using D13 and D12 of \$3B.



**Fig. 5-12.**

**§ 5-10. DFCT Countermeasure Circuit**

The DFCT countermeasure circuit maintains the directionality of the servo so that the servo does not become easily dislocated due to scratches or defects on discs.

Specifically, these operations are achieved by detecting scratches and defects with the DFCT signal generation circuit, and when DFCT goes high, applying the low frequency component of the error signal before DFCT went high to the FCS and TRK servo filter inputs. (See Fig. 5-13.)

In addition, these operations are activated by the default. They can be disabled by setting D7 (DFSW) of \$38 to 1.

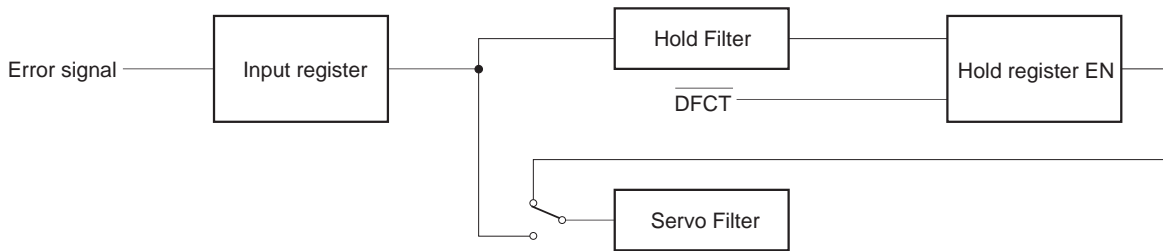

**Fig. 5-13.**

**§ 5-11. Anti-Shock Circuit**

When vibrations occur in the CD player, this circuit forces the TRK filter to switch to gain-up mode so that the servo does not become easily dislocated. This circuit is for systems which require vibration countermeasures.

Concretely, vibrations are detected using an internal anti-shock filter and comparator circuit, and the gain is increased. (See Fig. 5-14.)

The comparator level is fixed to 1/16 of the maximum comparator input amplitude. However, the comparator level is practically variable by adjusting the value of the anti-shock filter output coefficient K35.

This function can be turned on and off by D19 of \$1 when the brake circuit (described hereafter) is off. (See Table 5-17.)

This circuit can also support an external vibration detection circuit, and can set the TRK servo filter to gain-up mode by inputting high level to the ATSK pin.

When the upper 4 bits of the command register are 1 (Hex), vibration detection can be monitored from the SENS pin.

It also can be monitored from the ATSK pin by setting the ASOT command of \$3F to 0.

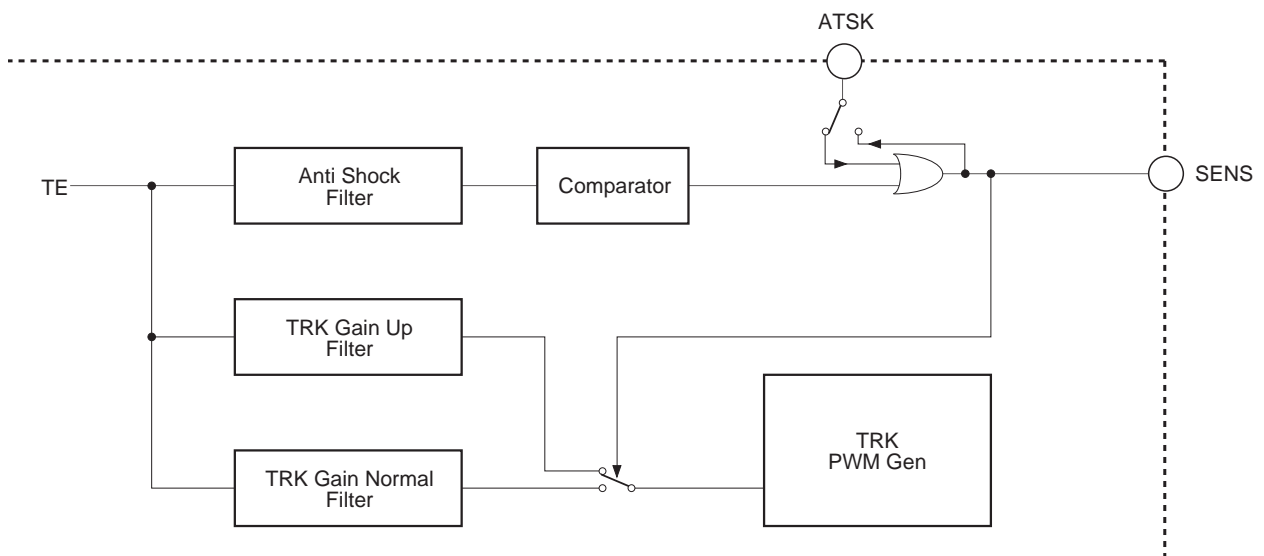

**Fig. 5-14.**

**§ 5-12. Brake Circuit**

Immediately after a long distance track jump it tends to be hard for the actuator to settle and for the servo to turn on.

The brake circuit prevents these phenomenon.

In principle, the brake circuit uses the tracking drive as a brake by cutting the unnecessary portions utilizing the 180° offset in the RF envelope and tracking error phase relationship which occurs when the actuator traverses the track in the radial direction from the inner track to the outer track and vice versa. (See Figs. 5-15 and 5-16.) Concretely, this operation is achieved by masking the tracking drive using the TRKCNCL signal generated by loading the MIRR signal at the edge of the TZC (Tracking Zero Cross) signal.

The brake circuit can be turned on and off by D18 of \$1. (See Fig. 5-17.)

In addition, the low frequency for the tracking drive after masking can be boosted. (SFBK1, 2 of \$34B)

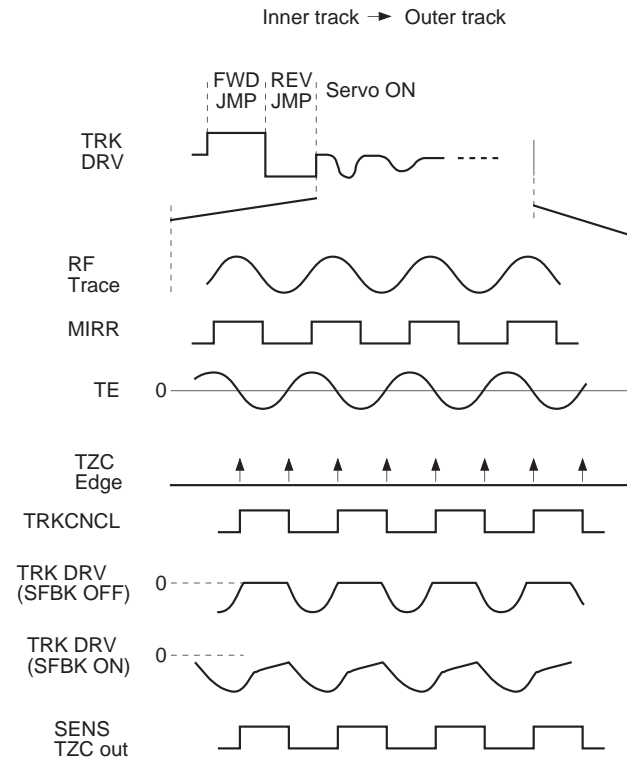

**Fig. 5-15.**

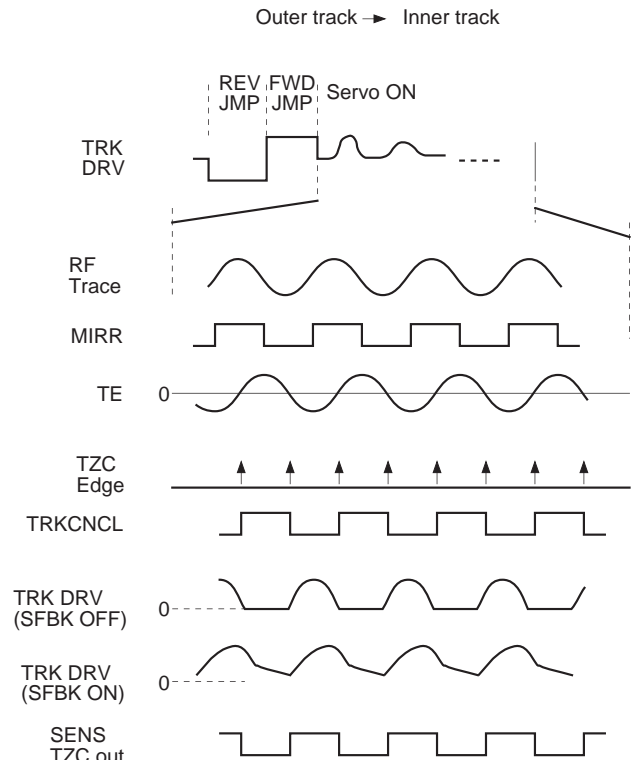

**Fig. 5-16.**

Register name	Command	D23 to D20	D19 to D16	
1	TRACKING CONTROL	0 0 0 1	1 0 * *	ANTI SHOCK ON
			0 * * *	ANTI SHOCK OFF
			* 1 * *	BRAKE ON
			* 0 * *	BRAKE OFF
			* * 0 *	TRACKING GAIN NORMAL
			* * 1 *	TRACKING GAIN UP
			* * * 1	TRACKING GAIN UP FILTER SELECT 1
			* * * 0	TRACKING GAIN UP FILTER SELECT 2

\*: Don't care

**Table 5-17.**

**§ 5-13. COUT Signal**

The COUT signal is output to count the number of tracks during traverse, etc. It is basically generated by loading the MIRR signal at both edges of the TZC signal. The used TZC signal can be selected from among three different phases according to the COUT signal application.

- HPTZC: For 1-track jumps  
Fast phase COUT signal generation with a fast phase TZC signal. (The TZC phase is advanced by a cutoff 1kHz digital HPF; when MCK = 128Fs.)
- STZC: For COUT generation when MIRR is externally input and for applications other than COUT generation.  
This is generated by sampling the TE signal at 700kHz. (when MCK = 128Fs)
- DTZC: For high-speed traverse  
Reliable COUT signal generation with a delayed phase STZC signal.

Since it takes some time to generate the MIRR signal, it is necessary to delay the TZC signal in accordance with the MIRR signal delay during high-speed traverse.

The COUT signal output method is switched with D15 and D14 of \$3C.

- When D15 = 1: STZC
- When D15 = 0 and D14 = 0: HPTZC
- When D15 = 0 and D14 = 1: DTZC
- When DTZC is selected, the delay can be selected from two values with D14 of \$36.

**§ 5-14. Serial Readout Circuit**

The following measurement and adjustment results can be read out from the SENS pin by inputting the readout clock to the SCLK pin by \$39. (See Fig. 5-18, Table 5-19 and "Description of SENS Signals".)

Specified commands

- \$390C: VC AVRG measurement result
- \$3908: FE AVRG measurement result
- \$3904: TE AVRG measurement result
- \$391F: RF AVRG measurement result
- \$3953: FCS AGCNTL coefficient result
- \$3963: TRK AGCNTL coefficient result
- \$391C: TRVSC adjustment result
- \$391D: FBIAS register value

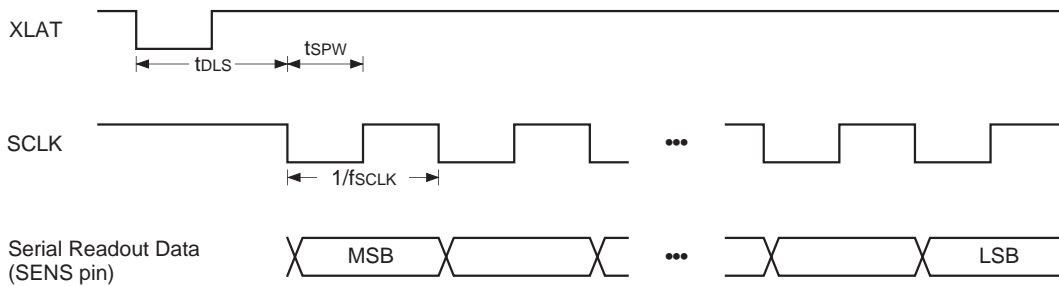

**Fig. 5-18.**

Item	Symbol	Min.	Typ.	Max.	Unit
SCLK frequency	f <sub>SCLK</sub>			16	MHz
SCLK pulse width	t <sub>SPW</sub>	31.3			ns
Delay time	t <sub>DLS</sub>	15			μs

**Table 5-19.**

During readout, the upper 8 bits of the command register must be 39 (Hex).

**§ 5-15. Writing to Coefficient RAM**

The coefficient RAM can be rewritten by \$34. All coefficients have default values in the built-in ROM, and transfer from the ROM to the RAM is completed approximately 40µs (when MCK = 128Fs) after the XRST pin rises. (The coefficient RAM cannot be rewritten during this period.)

After that, the characteristics of each built-in filter can be finely adjusted by rewriting the data for each address of the coefficient RAM.

The coefficient rewrite command is comprised of 24 bits, with D14 to D8 of \$34 as the address (D15 = 0) and D7 to D0 as data. Coefficient rewriting is completed 11.3µs (when MCK = 128Fs) after the command is received. When rewriting multiple coefficients, be sure to wait 11.3µs (when MCK = 128Fs) before sending the next rewrite command.

**§ 5-16. PWM Output**

FCS, TRK and SLD PWM format outputs are described below.

In particular, FCS and TRK use a double oversampling noise shaper.

Timing Chart 5-20 and Fig. 5-21 show examples of output waveforms and drive circuits.

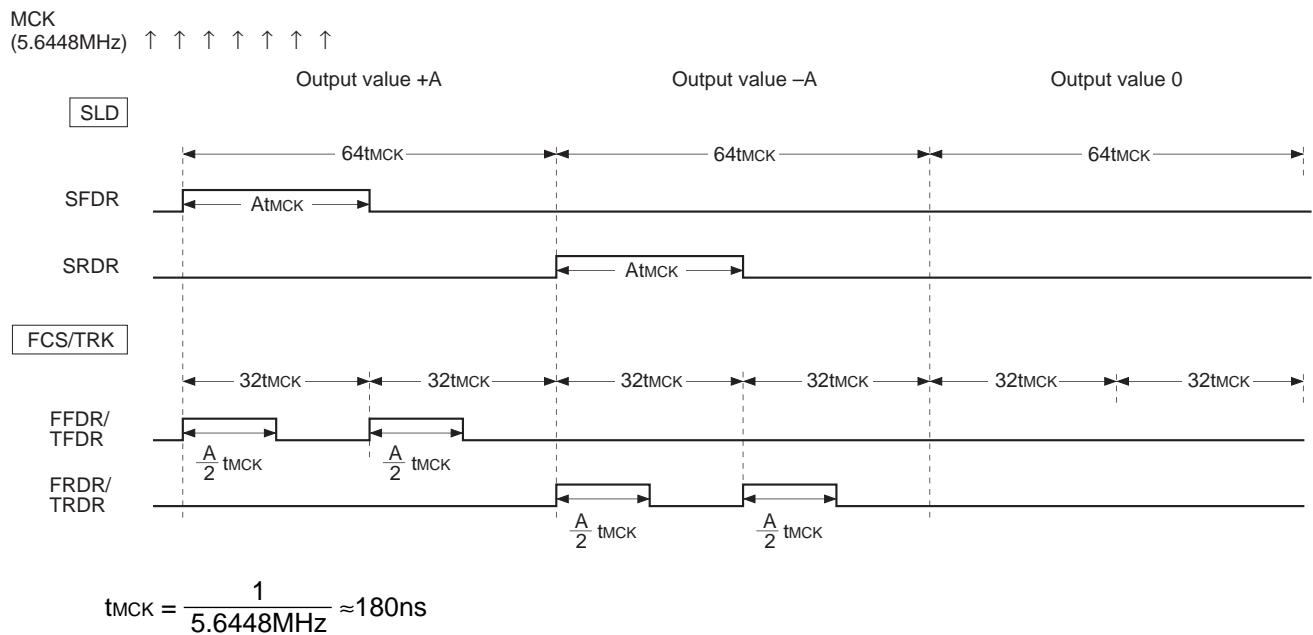

**Timing Chart 5-20.**

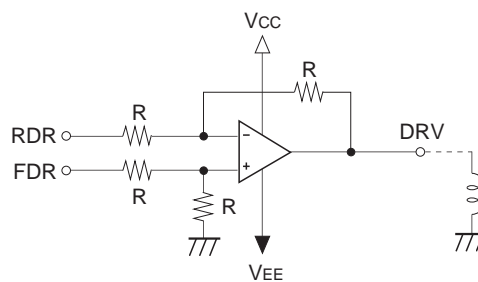

**Fig. 5-21. Drive Circuit**



**§ 5-17. Servo Status Changes Produced by LOCK Signal**

When the LOCK signal becomes low, the TRK servo switches to the gain-up mode and the SLD servo turns off in order to prevent SLD free-running.

Setting D6 (LKSW) of \$38 to 1 deactivates this function.

In other words, neither the TRK servo nor the SLD servo change even when the LOCK signal becomes low. This enables microcomputer control.

**§ 5-18. Description of Commands and Data Sets**

**\$34**

D15	D14	D13	D12	D11	D10	D9	D8	D7	D6	D5	D4	D3	D2	D1	D0
0	KA6	KA5	KA4	KA3	KA2	KA1	KA0	KD7	KD6	KD5	KD4	KD3	KD2	KD1	KD0

When D15 = 0.

KA6 to KA0: Coefficient address

KD7 to KD0: Coefficient data

**\$348 (preset: \$348 000)**

D15	D14	D13	D12	D11	D10	D9	D8	D7	D6	D5	D4	D3	D2	D1	D0
1	0	0	0	PGFS1	PGFS0	PFOK1	PFOK0	0	0	0	0	0	0	0	0

These commands set the GFS pin hold time. The hold time is inversely proportional to the playback speed.

PGFS1	PGFS0	Processing
0	0	High when the frame sync is of the correct timing, low when not the correct timing.
0	1	High when the frame sync is of the correct timing, low when continuously not the correct timing for 2ms or longer.
1	0	High when the frame sync is of the correct timing, low when continuously not the correct timing for 4ms or longer.
1	1	High when the frame sync is the correct timing, low when continuously not the correct timing for 8ms or longer.

These commands set the FOK hold time. See \$3B for the FOK slice level.

These are the values when MCK = 128Fs, and the hold time is inversely proportional to the MCK setting.

PFOK1	PFOK0	Processing
0	0	High when the RFDC value is higher than the FOK slice level, low when lower than the FOK slice level.
0	1	High when the RFDC value is higher than the FOK slice level, low when continuously lower than the FOK slice level for 4.35ms or more.
1	0	High when the RFDC value is higher than the FOK slice level, low when continuously lower than the FOK slice level for 10.16ms or more.
1	1	High when the RFDC value is higher than the FOK slice level, low when continuously lower than the FOK slice level for 21.77ms or more.

**\$34B (preset: \$34B 000)**

D15	D14	D13	D12	D11	D10	D9	D8	D7	D6	D5	D4	D3	D2	D1	D0
1	0	1	1	SFBK1	SFBK2	0	0	0	0	0	0	0	0	0	0

The low frequency can be boosted for brake operation.  
See § 5-12 for brake operation.

SFBK1: When 1, brake operation is performed by setting the LowBooster-1 input to 0.  
This is valid only when TLB1ON = 1. The preset is 0.

SFBK2: When 1, brake operation is performed by setting the LowBooster-2 input to 0.  
This is valid only when TLB2ON = 1. The preset is 0.

**\$34C (preset: \$34C 000)**

D15	D14	D13	D12	D11	D10	D9	D8	D7	D6	D5	D4	D3	D2	D1	D0
1	1	0	0	THB ON	FHB ON	TLB1 ON	FLB1 ON	TLB2 ON	0	HBST1	HBST0	LB1S1	LB1S0	LB2S1	LB2S0

These commands turn on the boost function. (See § 5-20. Filter Composition.)  
There are five boosters (three for the TRK filter and two for the FCS filter) which can be turned on and off independently.

THBON: When 1, the high frequency is boosted for the TRK filter. Preset when 0.

FHBON: When 1, the high frequency is boosted for the FCS filter. Preset when 0.

TLB1ON: When 1, the low frequency is boosted for the TRK filter. Preset when 0.

FLB1ON: When 1, the low frequency is boosted for the FCS filter. Preset when 0.

TLB2ON: When 1, the low frequency is boosted for the TRK filter. Preset when 0.

The difference between TLB1ON and TLB2ON is the position where the low frequency is boosted.  
For TLB1ON, the low frequency is boosted before the TRK jump, and for TLB2ON, after the TRK jump.

The following commands set the boosters. (See § 5-20. Filter Composition.)

HBST1, HBST0: TRK and FCS HighBooster setting.

HighBooster has the configuration shown in Fig. 5-24a, and can select three different combinations of coefficients BK1, BK2 and BK3. (See Table 5-25a.)

An example of characteristics is shown in Fig. 5-26a.

These characteristics are the same for both the TRK and FCS filters.

The sampling frequency is 88.2kHz (when MCK = 128Fs).

LB1S1, LB1S0: TRK and FCS LowBooster-1 setting.

LowBooster-1 has the configuration shown in Fig. 5-24b, and can select three different combinations of coefficients BK4, BK5 and BK6. (See Table 5-25b.)

An example of characteristics is shown in Fig. 5-26b.

These characteristics are the same for both the TRK and FCS filters.

The sampling frequency is 88.2kHz (when MCK = 128Fs).

LB2S1, LB2S0: TRK LowBooster-2 setting.

LowBooster-2 has the configuration shown in Fig. 5-24c, and can select three different combinations of coefficients BK7, BK8 and BK9. (See Table 5-25c.)

An example of characteristics is shown in Fig. 5-26c.

This booster is used exclusively for the TRK filter.

The sampling frequency is 88.2kHz (when MCK = 128Fs).

**Note)** Fs = 44.1kHz

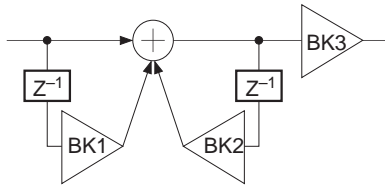

Fig. 5-24a.

HBST1	HBST0	HighBooster setting		
		BK1	BK2	BK3
0	—	-120/128	96/128	2
1	0	-124/128	112/128	2
1	1	-126/128	120/128	2

Table 5-25a.

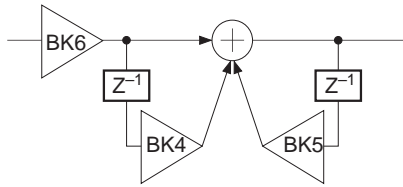

Fig. 5-24b.

LB1S1	LB1S0	LowBooster-1 setting		
		BK4	BK5	BK6
0	—	-255/256	1023/1024	1/4
1	0	-511/512	2047/2048	1/4
1	1	-1023/1024	4095/4096	1/4

Table 5-25b.

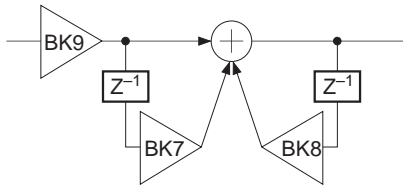
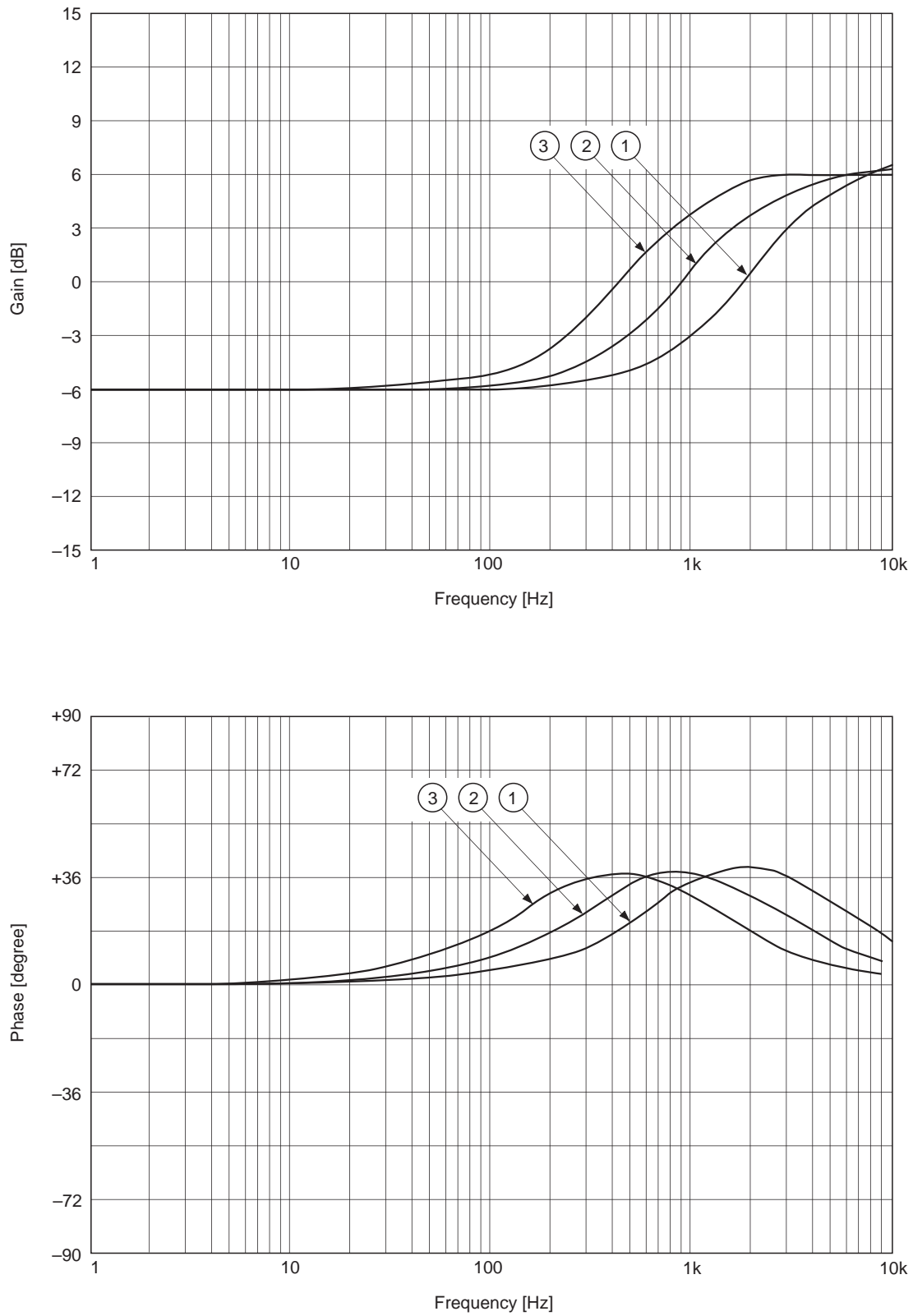

Fig. 5-24c.

LB2S1	LB2S0	LowBooster-2 setting		
		BK7	BK8	BK9
0	—	-255/256	1023/1024	1/4
1	0	-511/512	2047/2048	1/4
1	1	-1023/1024	4095/4096	1/4

Table 5-25c.

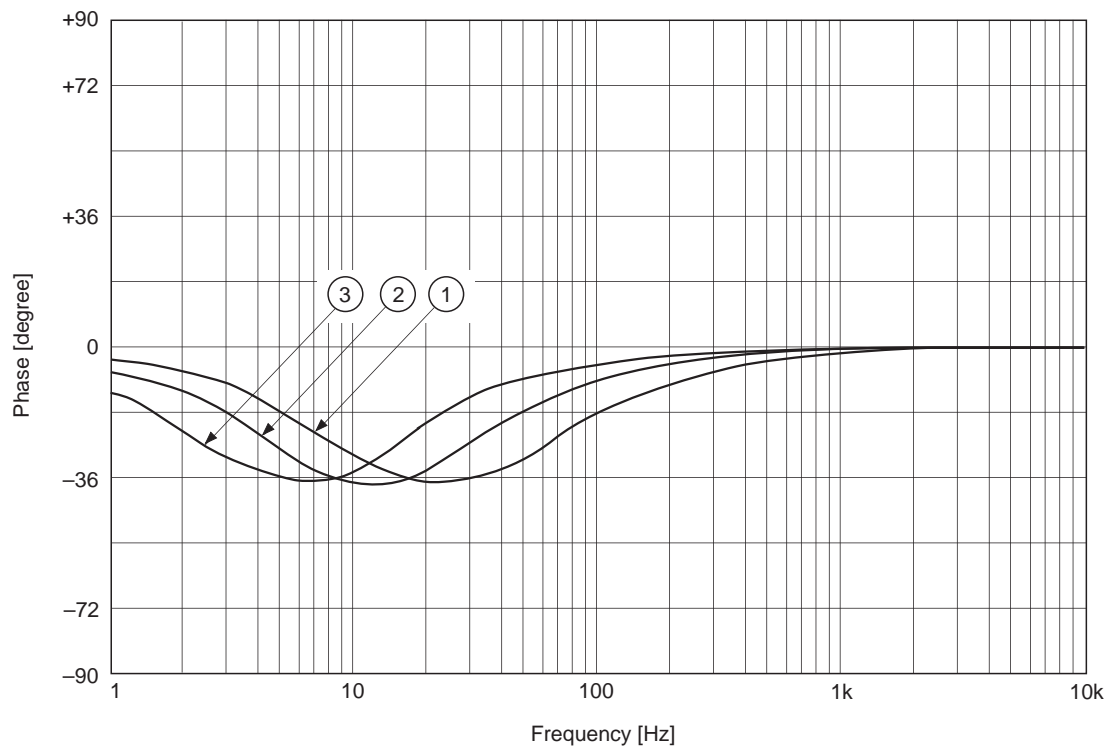
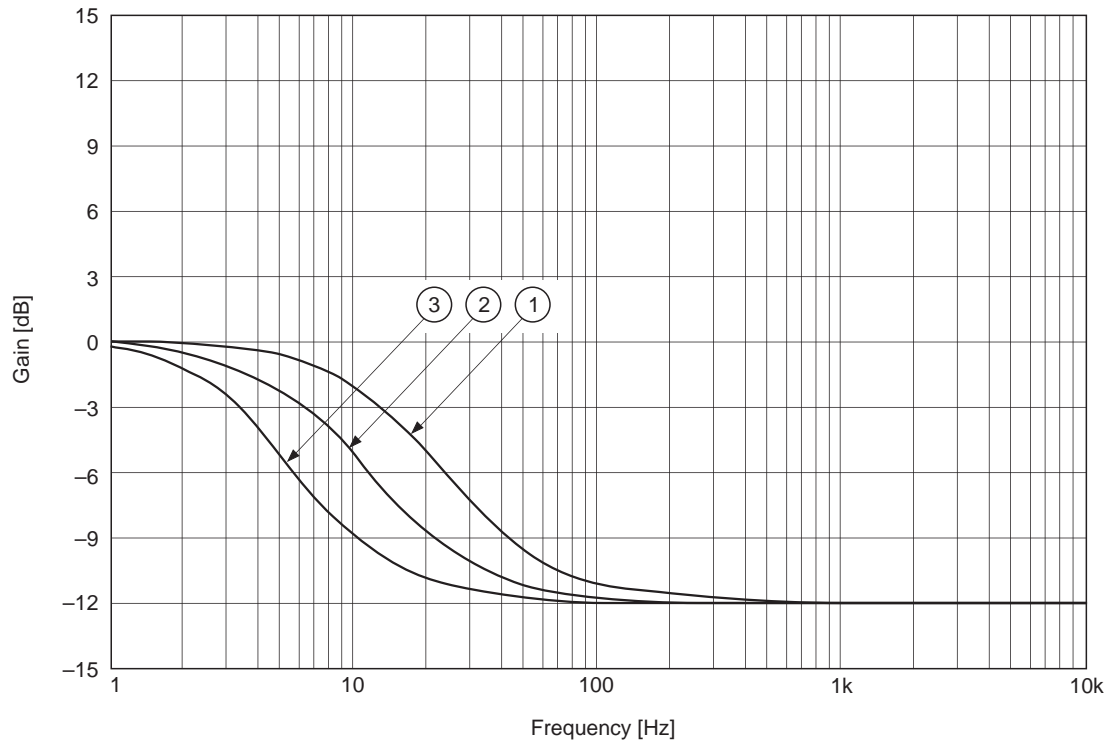

**Fig. 5-26a. Servo HighBooster Characteristics [FCS, TRK] (MCK = 128Fs)**

① HBST1 = 0

② HBST1 = 1, HBST0 = 0

③ HBST1 = 1, HBST0 = 1



**Fig. 5-26b. Servo LowBooster1 Characteristics [FCS, TRK] (MCK = 128Fs)**

- ① LB1S1 = 0      ② LB1S1 = 1, LB1S0 = 0      ③ LB1S1 = 1, LB1S0 = 1

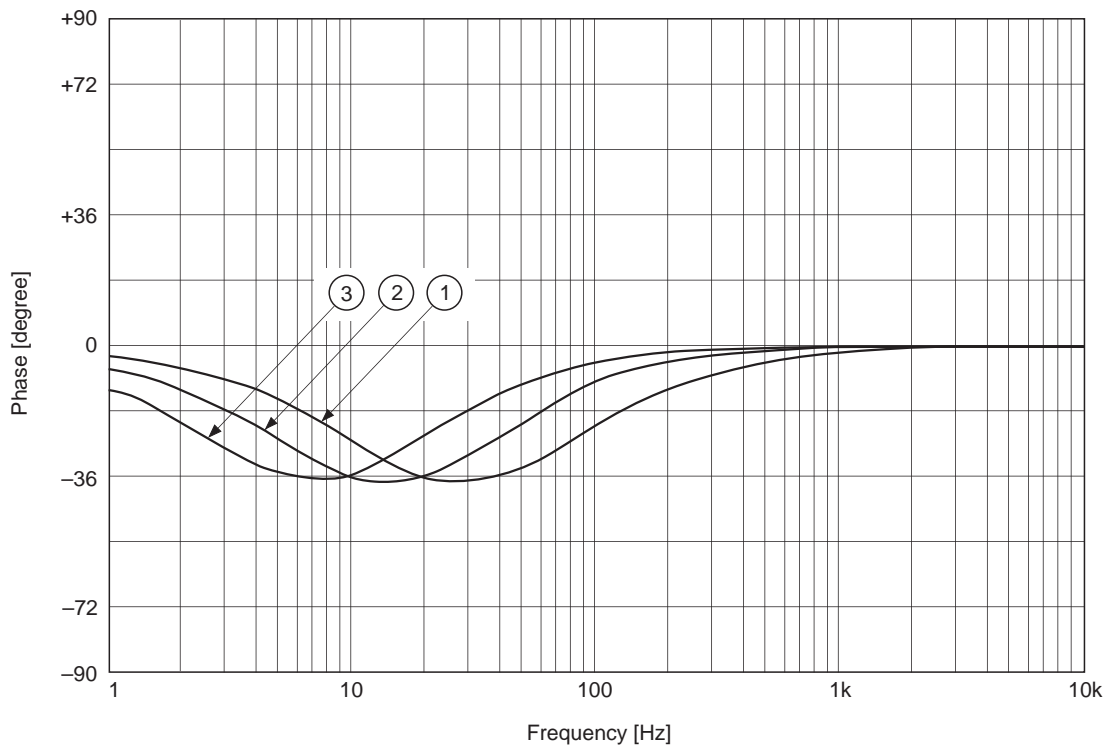
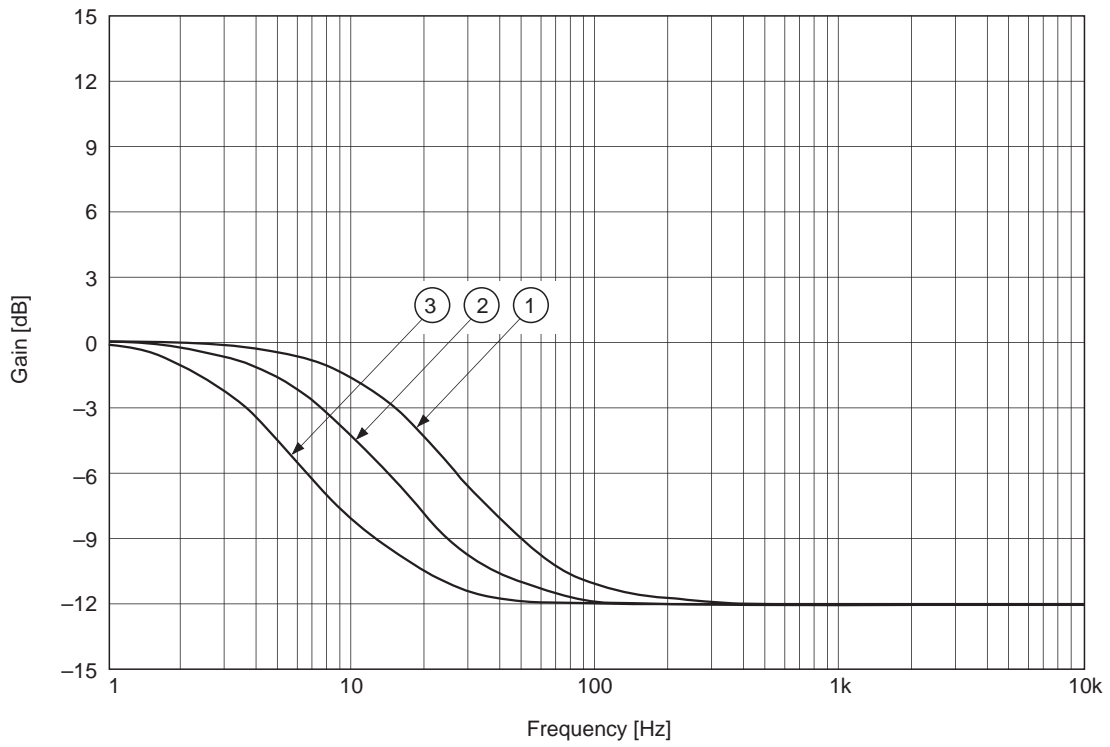

**Fig. 5-26c. Servo LowBooster2 Characteristics [FCS, TRK] (MCK = 128Fs)**

① LB2S1 = 0

② LB2S1 = 1, LB2S0 = 0

③ LB2S1 = 1, LB2S0 = 1

**\$34F**

D15	D14	D13	D12	D11	D10	D9	D8	D7	D6	D5	D4	D3	D2	D1	D0
1	1	1	1	1	0	FBL9	FBL8	FBL7	FBL6	FBL5	FBL4	FBL3	FBL2	FBL1	—

When D15 = D14 = D13 = D12 = D11 = 1 (\$34F)

D10 = 0

FBIAS LIMIT register write

FBL9 to FBL1: Data; data compared with FB9 to FB1, FBL9 = MSB.

When using the FBIAS register in counter mode, counter operation stops when the value of FB9 to FB1 matches with FBL9 to FBL1.

D15	D14	D13	D12	D11	D10	D9	D8	D7	D6	D5	D4	D3	D2	D1	D0
1	1	1	1	0	1	FB9	FB8	FB7	FB6	FB5	FB4	FB3	FB2	FB1	—

When D15 = D14 = D13 = D12 = 1 (\$34F)

D11 = 0, D10 = 1

FBIAS register write

FB9 to FB1: Data; two's complement data, FB9 = MSB.

For FE input conversion, FB9 to FB1 = 011111111 corresponds to  $255/256 \times V_{DD}/5$  and FB9 to FB1 = 100000000 to  $-256/256 \times V_{DD}/5$  respectively. ( $V_{DD}$ : supply voltage)

D15	D14	D13	D12	D11	D10	D9	D8	D7	D6	D5	D4	D3	D2	D1	D0
1	1	1	1	0	0	TV9	TV8	TV7	TV6	TV5	TV4	TV3	TV2	TV1	TV0

When D15 = D14 = D13 = D12 = 1 (\$34F)

D11 = 0, D10 = 0

TRVSC register write

TV9 to TV0: Data; two's complement data, TV9 = MSB.

For TE input conversion, TV9 to TV0 = 001111111 corresponds to  $255/256 \times V_{DD}/5$  and TV9 to TV0 = 110000000 to  $-256/256 \times V_{DD}/5$  respectively. ( $V_{DD}$ : supply voltage)

- Note)**
- When the TRVSC register is read out, the data length is 9 bits. At this time, data corresponding to each bit TV8 to TV0 during external write are read out.
  - When reading out internally measured values and then writing these values externally, set TV9 the same as TV8.

**\$35 (preset: \$35 58 2D)**

D15	D14	D13	D12	D11	D10	D9	D8	D7	D6	D5	D4	D3	D2	D1	D0
FT1	FT0	FS5	FS4	FS3	FS2	FS1	FS0	FTZ	FG6	FG5	FG4	FG3	FG2	FG1	FG0

FT1, FT0, FTZ: Focus search-up speed

Default value: 010 ( $0.673 \times V_{DD}$  V/s)

Focus drive output conversion

	FT1	FT0	FTZ	Focus search speed [V/s]
	0	0	0	$1.35 \times V_{DD}$
*	0	1	0	$0.673 \times V_{DD}$
	1	0	0	$0.449 \times V_{DD}$
	1	1	0	$0.336 \times V_{DD}$
	0	0	1	$1.79 \times V_{DD}$
	0	1	1	$1.08 \times V_{DD}$
	1	0	1	$0.897 \times V_{DD}$
	1	1	1	$0.769 \times V_{DD}$

\*: preset,  $V_{DD}$ : PWM driver supply voltage

FS5 to FS0: Focus search limit voltage

Default value: 011000 ( $\pm 24/64 \times V_{DD}$ ,  $V_{DD}$ : PWM driver supply voltage)

Focus drive output conversion

FG6 to FG0: AGF convergence gain setting value

Default value: 0101101

**\$36 (preset: \$36 0E 2E)**

D15	D14	D13	D12	D11	D10	D9	D8	D7	D6	D5	D4	D3	D2	D1	D0
TDZC	DTZC	TJ5	TJ4	TJ3	TJ2	TJ1	TJ0	SFJP	TG6	TG5	TG4	TG3	TG2	TG1	TG0

TDZC: Selects the TZC signal for generating the TRKCNCL signal during brake circuit operation.  
 TDZC = 0: The edge of the HPTZC or STZC signal, whichever has the faster phase, is used.  
 TDZC = 1: The edge of the HPTZC or STZC signal or the tracking drive signal zero-cross, whichever has the fastest phase, is used. (See § 5-12.)

DTZC: DTZC delay ( $8.5/4.25\mu\text{s}$ , when MCK = 128Fs)

Default value: 0 ( $4.25\mu\text{s}$ )

TJ5 to TJ0: Track jump voltage

Default value: 001110 ( $\approx \pm 14/64 \times V_{DD}$ ,  $V_{DD}$ : PWM driver supply voltage)

Tracking drive output conversion

SFJP: Surf jump mode on/off

The tracking PWM output is generated by adding the tracking filter output and TJReg (TJ5 to 0), by setting D7 to 1 (on)

TG6 to TG0: AGT convergence gain setting value

Default value: 0101110



**\$37 (preset: \$37 50 BA)**

D15	D14	D13	D12	D11	D10	D9	D8	D7	D6	D5	D4	D3	D2	D1	D0
FZSH	FZSL	SM5	SM4	SM3	SM2	SM1	SM0	AGS	AGJ	AGGF	AGGT	AGV1	AGV2	AGHS	AGHT

FZSH, FZSL: FZC (Focus Zero Cross) slice level  
 Default value: 01 ( $1/8 \times V_{DD} \times 0.4$ ,  $V_{DD}$ : supply voltage); FE input conversion

FZSH	FZSL	Slice level
0	0	$1/4 \times V_{DD} \times 0.4$
* 0	1	$1/8 \times V_{DD} \times 0.4$
1	0	$1/16 \times V_{DD} \times 0.4$
1	1	$1/32 \times V_{DD} \times 0.4$

\*: preset

SM5 to SM0: Sled move voltage  
 Default value: 010000 ( $\approx \pm 16/64 \times V_{DD}$ ,  $V_{DD}$ : PWM driver supply voltage)  
 Sled drive output conversion

AGS: AGCNTL self-stop on/off  
 Default value: 1 (on)

AGJ: AGCNTL convergence completion judgment time during low sensitivity adjustment (31/63ms, when MCK = 128Fs)  
 Default value: 0 (63ms)

AGGF: Focus AGCNTL internally generated sine wave amplitude (small/large)  
 Default value: 1 (large)

AGGT: Tracking AGCNTL internally generated sine wave amplitude (small/large)  
 Default value: 1 (large)

	FE/TE input conversion
AGGF 0 (small)	$1/32 \times V_{DD} \times 0.4$
1 (large)*	$1/16 \times V_{DD} \times 0.4$
AGGT 0 (small)	$1/16 \times V_{DD} \times 0.4$
1 (large)*	$1/8 \times V_{DD} \times 0.4$

\*: preset

AGV1: AGCNTL convergence sensitivity during high sensitivity adjustment; high/low  
 Default value: 1 (high)

AGV2: AGCNTL convergence sensitivity during low sensitivity adjustment; high/low  
 Default value: 0 (low)

AGHS: AGCNTL high sensitivity adjustment on/off  
 Default value: 1 (on)

AGHT: AGCNTL high sensitivity adjustment time (128/256ms, when MCK = 128Fs)  
 Default value: 0 (256ms)

**\$38 (preset: \$38 00 00)**

D15	D14	D13	D12	D11	D10	D9	D8	D7	D6	D5	D4	D3	D2	D1	D0
VCLM	VCLC	FLM	FLC0	RFLM	RFLC	AGF	AGT	DFSW	LKSW	TBLM	TCLM	FLC1	TLC2	TLC1	TLC0

\*VCLM: VC level measurement (on/off)

VCLC: VC level compensation for FCS In register (on/off)

\*FLM: Focus zero level measurement (on/off)

FLC0: Focus zero level compensation for FZC register (on/off)

\*RFLM: RF zero level measurement (on/off)

RFLC: RF zero level compensation (on/off)

AGF: Focus auto gain adjustment (on/off)

AGT: Tracking auto gain adjustment (on/off)

DFSW: Defect disable switch (on/off)

Setting this switch to 1 (on) disables the defect countermeasure circuit.

LKSW: Lock switch (on/off)

Setting this switch to 1 (on) disables the sled free-running prevention circuit.

TBLM: Traverse center measurement (on/off)

\*TCLM: Tracking zero level measurement (on/off)

FLC1: Focus zero level compensation for FCS In register (on/off)

TLC2: Traverse center compensation (on/off)

TLC1: Tracking zero level compensation (on/off)

TLC0: VC level compensation for TRK/SLD In register (on/off)

**Note)** Commands marked with \* are accepted every 2.9ms. (when MCK = 128Fs)

All commands are on when 1.

\$39

D15	D14	D13	D12	D11	D10	D9	D8
DAC	SD6	SD5	SD4	SD3	SD2	SD1	SD0

DAC: Serial data readout DAC mode (on/off)

SD6 to SD0: Serial readout data select

SD6	SD5	Readout data			Readout data length	
1	Coefficient RAM data for address = SD5 to SD0			8 bits		
0	1	Data RAM data for address = SD4 to SD0			16 bits	
0	0	SD4	SD3 to SD0			
		1	1 1 1 1	RF AVR register	8 bits	\$399F
			1 1 1 0	RFDC input signal	8 bits	\$399E
			1 1 0 1	FBIAS register	9 bits	\$399D
			1 1 0 0	TRVSC register	9 bits	\$399C
			0 0 1 1	RFDC envelope (bottom)	8 bits	\$3993
			0 0 1 0	RFDC envelope (peak)	8 bits	\$3992
			0 0 0 1	RFDC envelope (peak) – (bottom)	8 bits	\$3991
			0	1 1 * *	VC AVR register	9 bits
		1 0 * *		FE AVR register	9 bits	\$3988
		0 1 * *		TE AVR register	9 bits	\$3984
		0 0 1 1		FE input signal	8 bits	\$3983
		0 0 1 0		TE input signal	8 bits	\$3982
		0 0 0 1		SE input signal	8 bits	\$3981
		0 0 0 0	VC input signal	8 bits	\$3980	

\*: Don't care

**Note)** Coefficients K40 to K4F cannot be read out.

See the Description for Data Readout concerning readout methods for the above data.

**\$3A (preset: \$3A 00 00)**

D15	D14	D13	D12	D11	D10	D9	D8	D7	D6	D5	D4	D3	D2	D1	D0
0	FBON	FBSS	FBUP	FBV1	FBV0	0	TJD0	FPS1	FPS0	TPS1	TPS0	0	SJHD	INBK	MTI0

**FBON:** FBIAS (focus bias) register addition (on/off)  
 The FBIAS register value is added to the signal loaded into the FCS In register by setting FBON = 1 (on).

**FBSS:** FBIAS (focus bias) register/counter switching  
 FBSS = 0: register, FBSS = 1: counter.

**FBUP:** FBIAS (focus bias) counter up/down operation switching  
 This performs counter up/down control when FBSS = 1. FBUP = 0: down counter, FBUP = 1: up counter.

**FBV1, FBV0:** FBIAS (focus bias) counter voltage switching  
 The number of FCS BIAS count-up/-down steps per cycle is decided by these bits.

	FBV1	FBV0	Number of steps per cycle
*	0	0	1
	0	1	2
	1	0	4
	1	1	8

The counter changes once for each sampling cycle of the focus servo filter. When MCK is 128Fs, the sampling frequency is 88.2kHz. When converted to FE input, 1 step is approximately  $1/2^9 \times V_{DD} \times 0.4$ ,  $V_{DD}$  = supply voltage.

\*: preset

**TJD0:** This sets the tracking servo filter data RAM to 0 when switched from track jump to servo on only when SFJP = 1 (during surf jump operation).

**FPS1, FPS0:** Gain setting when transferring data from the focus filter to the PWM block.

**TPS1, TPS0:** Gain setting when transferring data from the tracking filter to the PWM block.

These are effective for increasing the overall gain in order to widen the servo band. Operation when FPS1, FPS0 (TPS1, TPS0) = 00 is the same as usual (7-bit shift). However, 6dB, 12dB and 18dB can be selected independently for focus and tracking by setting the relative gain to 0dB when FPS1, FPS0 (TPS1, TPS0) = 00.

	FPS1	FPS0	Relative gain		TPS1	TPS0	Relative gain	
*	0	0	0dB		0	0	0dB	*
	0	1	+6dB		0	1	+6dB	
	1	0	+12dB		1	0	+12dB	
	1	1	+18dB		1	1	+18dB	

\*: preset

**SJHD:** This holds the tracking filter output at the value when surf jump starts during surf jump.

**INBK:** When INBK = 0 (off), the brake circuit masks the tracking drive signal with TRKCNCL which is generated by fetching the MIRR signal at the TZC edge. When INBK = 1 (on), the tracking filter input is masked instead of the drive output.

**MTI0:** The tracking filter input is masked when the MIRR signal is high by setting MTI0 = 1 (on).

**\$3B (preset: \$3B E0 50)**

D15	D14	D13	D12	D11	D10	D9	D8	D7	D6	D5	D4	D3	D2	D1	D0
SFO2	SFO1	SDF2	SDF1	MAX2	MAX1	SFOX	BTF	D2V2	D2V1	D1V2	D1V1	RINT	0	0	0

SFOX, SFO2, SFO1: FOK slice level

Default value: 011 ( $28/256 \times V_{DD} \times 0.57$ ,  $V_{DD}$  = supply voltage)

RFDC input conversion

SFOX	SFO2	SFO1	Slice level
0	0	0	$16/256 \times V_{DD} \times 0.57$
0	0	1	$20/256 \times V_{DD} \times 0.57$
0	1	0	$24/256 \times V_{DD} \times 0.57$
* 0	1	1	$28/256 \times V_{DD} \times 0.57$
1	0	0	$32/256 \times V_{DD} \times 0.57$
1	0	1	$40/256 \times V_{DD} \times 0.57$
1	1	0	$48/256 \times V_{DD} \times 0.57$
1	1	1	$56/256 \times V_{DD} \times 0.57$

\*: preset

SDF2, SDF1: DFCT slice level

Default value: 10 ( $0.0313 \times V_{DD} \times 1.14V$ )

RFDC input conversion

SDF2	SDF1	Slice level
0	0	$0.0156 \times V_{DD} \times 1.14$
0	1	$0.0234 \times V_{DD} \times 1.14$
* 1	0	$0.0313 \times V_{DD} \times 1.14$
1	1	$0.0391 \times V_{DD} \times 1.14$

\*: preset,  $V_{DD}$ : supply voltage

MAX2, MAX1: DFCT maximum time (MCK = 128Fs)

Default value: 00 (no timer limit)

MAX2	MAX1	DFCT maximum time
* 0	0	No timer limit
0	1	2.00ms
1	0	2.36
1	1	2.72

\*: preset

BTF: Bottom hold double-speed count-up mode for MIRR signal generation

On/off (default: off)

On when set to 1.

D2V2, D2V1: Peak hold 2 for DFCT signal generation

Count-down speed setting

Default value: 01 ( $0.086 \times V_{DD} \times 1.14\text{V/ms}$ , 44.1kHz)

[V/ms] unit items indicate RFDC input conversion; [kHz] unit items indicate the operating frequency of the internal counter.

	D2V2	D2V1	Count-down speed	
			[V/ms]	[kHz]
*	0	0	$0.0431 \times V_{DD} \times 1.14$	22.05
	0	1	$0.0861 \times V_{DD} \times 1.14$	44.1
	1	0	$0.172 \times V_{DD} \times 1.14$	88.2
	1	1	$0.344 \times V_{DD} \times 1.14$	176.4

\*: preset,  $V_{DD}$ : supply voltage

D1V2, D1V1: Peak hold 1 for DFCT signal generation

Count-down speed setting

Default value: 01 ( $0.688 \times V_{DD} \times 1.14\text{V/ms}$ , 352.8kHz)

[V/ms] unit items indicate RFDC input conversion; [kHz] unit items indicate the operating frequency of the internal counter.

	D1V2	D2V1	Count-down speed	
			[V/ms]	[kHz]
*	0	0	$0.344 \times V_{DD} \times 1.14$	176.4
	0	1	$0.688 \times V_{DD} \times 1.14$	352.8
	1	0	$1.38 \times V_{DD} \times 1.14$	705.6
	1	1	$2.75 \times V_{DD} \times 1.14$	1411.2

\*: preset,  $V_{DD}$ : supply voltage

RINT: This initializes the initial-state registers of the circuits which generate MIRR, DFCT and FOK.

**\$3C (preset: \$3C 00 80)**

D15	D14	D13	D12	D11	D10	D9	D8	D7	D6	D5	D4	D3	D2	D1	D0
COSS	COTS	CETZ	CETF	COT2	COT1	MOT2	0	BTS1	BTS0	MRC1	MRC0	0	0	0	0

COSS, COTS: This selects the TZC signal used when generating the COUT signal.

Preset = HPTZC.

	COSS	COTS	TZC
*	1	—	STZC
	0	0	HPTZC
	0	1	DTZC

\*: preset, —: don't care

STZC is the TZC generated by sampling the TE signal at 700kHz. (when MCK = 128Fs)

DTZC is the delayed phase STZC. (The delay time can be selected by D14 of \$36.)

HPTZC is the fast phase TZC passed through a HPF with a cut-off frequency of 1kHz.

See § 5-13.

CETZ: The input from the TE pin normally enters the TRK filter and is used to generate the TZC signal. However, the input from the CE pin can also be used. This function is for the center error servo.

When 0, the TZC signal is generated by using the signal input to the TE pin.

When 1, the TZC signal is generated by using the signal input to the CE pin.

CETF: When 0, the signal input to the TE pin is input to the TRK servo filter.

When 1, the signal input to the CE pin is input to the TRK servo filter.

These commands output the TZC signal.

COT2, COT1: This outputs the TZC signal from the COUT pin.

	COT2	COT1	COUT pin output
*	1	—	STZC
	0	1	HPTZC
	0	0	COUT

\*: preset, —: don't care

MOT2: The STZC signal is output from the MIRR pin by setting MOT2 to 1.

These commands set the MIRR signal generation circuit.

BTS1, BTS0: This sets the count-up speed for the bottom hold value of the MIRR generation circuit.

The time per step is approximately 708ns (when MCK = 128Fs). The preset value is BTS1 = 1, BTS0 = 0 like the CXD2586R. This is valid only when BTF of \$3B is 0.

MRC1, MRC0: This sets the minimum pulse width for masking the MIRR signal of the MIRR generation circuit.

As noted in § 5-9, the MIRR signal is generated by comparing the waveform obtained by subtracting the bottom hold value from the peak hold value with the MIRR comparator level. Strictly speaking, however, for MIRR to become high, these levels must be compared continuously for a certain time. This sets that time.

The preset value is MRC1 = 0, MRC0 = 0 like the CXD2586R.

	BTS1	BTS0	Number of count-up steps per cycle
*	0	0	1
	0	1	2
	1	0	4
	1	1	8

	MRC1	MRC0	Setting time [μs]
*	0	0	5.669*
	0	1	11.338
	1	0	22.675
	1	1	45.351

\*: preset (when MCK = 128Fs)

**\$3D (preset: \$3D 00 00)**

D15	D14	D13	D12	D11	D10	D9	D8	D7	D6	D5	D4	D3	D2	D1	D0
SFID	SFSK	THID	THSK	0	TLD2	TLD1	TLD0	0	0	0	0	0	0	0	0

**SFID:** SLED servo filter input can be obtained not from SLD in Reg, but from M0D, which is the TRK filter second-stage output.

When the low frequency component of the tracking error signal obtained from the RF amplifier is attenuated, the low frequency can be amplified and input to the SLD servo filter.

**SFSK:** Only during TRK servo gain up2 operation, coefficient K30 is used instead of K00. Normally, the DC gain between the TE input pin and M0D changes for TRK filter gain normal and gain up2, creating a difference in the DC level at M0D. In this case, the DC level of the signal transmitted to M00 can be kept uniform by adjusting the K30 value even during the above switching.

**THID:** TRK hold filter input can be obtained not from SLD in Reg, but from M0D, which is the TRK filter second-stage output.

When signals other than the tracking error signal from the RF amplifier are input to the SE input pin, the signal transmitted from the TE pin can be obtained as the TRK hold filter input.

**THSK:** Only during TRK servo gain up2 operation, coefficient K46 is used instead of K40. Normally, the DC gain between the TE input pin and M0D changes for TRK filter gain normal and gain up2, creating a difference in the DC level at M0D. In this case, the DC level of the signal transmitted to M18 can be kept uniform by adjusting the K46 value even during the above switching.

\* See § 5-21. Filter Composition regarding the SFID, SFSK, THID and THSK commands.

**TLD0 to 2:** This turns on and off SLD filter correction independently of the TRK filter. See \$38 (TLC0 to 2) and Fig. 5-3.

TLC2	TLD2	Traverse center correction	
		TRK filter	SLD filter
0	—	OFF	OFF
1	0	ON	ON
	1	ON	OFF

TLC1	TLD1	Tracking zero level correction	
		TRK filter	SLD filter
0	—	OFF	OFF
1	0	ON	ON
	1	ON	OFF

TLC0	TLD0	VC level correction	
		TRK filter	SLD filter
0	—	OFF	OFF
1	0	ON	ON
	1	ON	OFF

\*: preset, —: don't care



• Input coefficient sign inversion when SFID = 1 and THID = 1

The preset coefficients for the TRK filter are negative for input and positive for output. With this, the CXD2585Q outputs the servo drives which have the reversed phase to the error inputs..

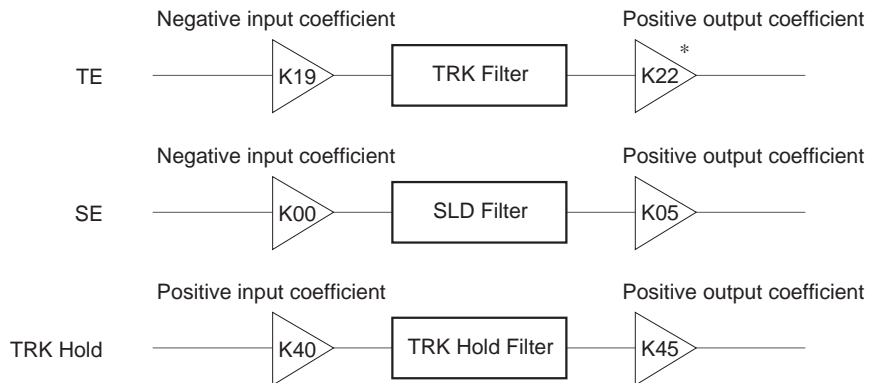

When SFID = 1, the TRK filter negative input coefficient is applied to the SLD filter, so invert the SLD input coefficient (K00) sign. (For example, inverting the sign for coefficient K00: E0Hex results in 60Hex.) For the same reason, when THID = 1, invert the TRK hold input coefficient (K40) sign.

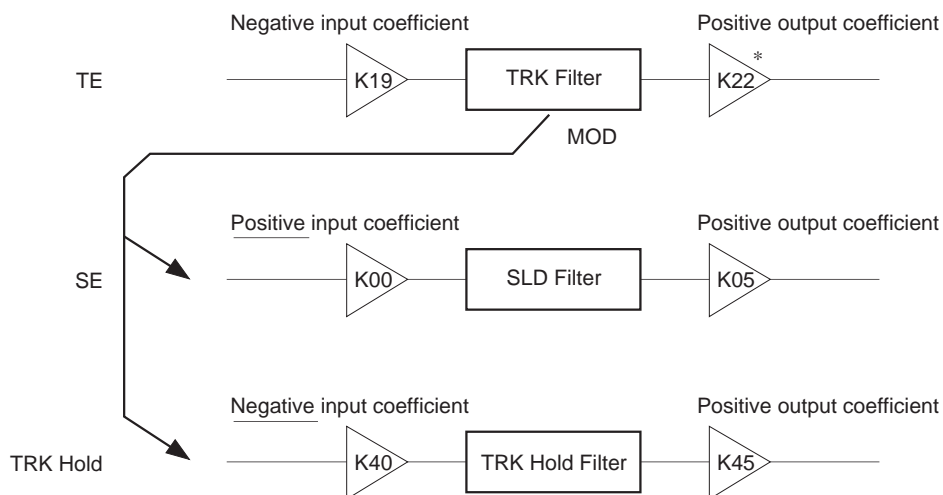

\* for TRK servo gain normal  
See § 5-21. Filter Composition.

**\$3E (preset: \$3E 00 00)**

D15	D14	D13	D12	D11	D10	D9	D8	D7	D6	D5	D4	D3	D2	D1	D0
F1NM	F1DM	F3NM	F3DM	T1NM	T1UM	T3NM	T3UM	DFIS	TLCD	0	LKIN	COIN	MDFI	MIRI	XT1D

- F1NM, F1DM: Quasi double accuracy setting for FCS servo filter first-stage  
On when 1; default when 0.  
F1NM: Gain normal  
F1DM: Gain down
- T1NM, T1UM: Quasi double accuracy setting for TRK servo filter first-stage  
On when 1; default when 0.  
T1NM: Gain normal  
T1UM: Gain up
- F3NM, F3DM: Quasi double accuracy setting for FCS servo filter third-stage  
On when 1; default when 0.  
Generally, the advance amount of the phase becomes large by partially setting the FCS servo third-stage filter which is used as the phase compensation filter to double accuracy.  
F3NM: Gain normal  
F3DM: Gain down
- T3NM, T3UM: Quasi double accuracy setting for TRK servo filter third-stage  
On when 1; default when 0.  
Generally, the advance amount of the phase becomes large by partially setting the TRK servo third-stage filter which is used as the phase compensation filter to double accuracy.  
T3NM: Gain normal  
T3UM: Gain up

**Note)** Filter first- and third-stage quasi double accuracy settings can be set individually.  
See § 5-20 Filter Composition at the end of this specification concerning quasi double accuracy.

- DFIS: FCS hold filter input extraction node selection  
0: M05 (Data RAM address 05); default  
1: M04 (Data RAM address 04)
- TLCD: This command masks the TLC2 command set by D2 of \$38 only when FOK is low.  
On when 1; default when 0
- LKIN: When 0, the internally generated LOCK signal is output to the LOCK pin. (default)  
When 1, the LOCK signal can be input from an external source to the LOCK pin.
- COIN: When 0, the internally generated COUT signal is output to the COUT pin. (default)  
When 1, the COUT signal can be input from an external source to the COUT pin.

The MIRR, DFCT and FOK signals can also be input from an external source.

- MDFI: When 0, the MIRR, DFCT and FOK signals are generated internally. (default)  
When 1, the MIRR, DFCT and FOK signals can be input from an external source through the MIRR, DFCT and FOK pins.
- MIRI: When 0, the MIRR signal is generated internally. (default)  
When 1, the MIRR signal can be input from an external source through the MIRR pin.

	MDFI	MIRI	
*	0	0	MIRR, DFCT and FOK are all generated internally.
	0	1	MIRR only is input from an external source.
	1	—	MIRR, DFCT and FOK are all input from an external source.

\*: preset, —: don't care

- XT1D: When XT1D = 1, the input to the servo master clock can be used without dividing its frequency. This command takes precedence over the XTSL pin, XT2D and XT4D. See the description of \$3F for XT2D and XT4D.

**\$3F (preset: \$3F 00 00)**

D15	D14	D13	D12	D11	D10	D9	D8	D7	D6	D5	D4	D3	D2	D1	D0
0	AGG4	XT4D	XT2D	0	DRR2	DRR1	DRR0	0	ASFG	FTQ	LPAS	0	0	AGHF	0

**AGG4:** This varies the amplitude of the internally generated sine wave using the AGGF and AGGT commands during AGC. When AGG4 = 0, the default is used. When AGG4 = 1, the setting is as shown in the table below.

AGG4	AGGF	AGGT	Sine wave amplitude	
			FE input conversion	TE input conversion
0	0	—	$1/36 \times V_{DD} \times 0.4$	—
	1	—	$1/16 \times V_{DD} \times 0.4$	—
	—	0	—	$1/16 \times V_{DD} \times 0.4$
	—	1	—	$1/8 \times V_{DD} \times 0.4^*$
1	0	0	$1/64 \times V_{DD} \times 0.4$	
	0	1	$1/32 \times V_{DD} \times 0.4$	
	1	0	$1/16 \times V_{DD} \times 0.4$	
	1	1	$1/8 \times V_{DD} \times 0.4$	

See \$37 for AGGF and AGGT. The presets are AGG4 = 0, AGGF = 1 and AGGT = 1. \*: preset, —: don't care

**XT4D, XT2D:** MCK (digital servo master clock) frequency division setting  
This command forcibly sets the frequency division ratio to 1/4, 1/2 or 1/1 when MCK is generated. See the description of \$3E for XT1D. Also, see the description of \$5-2. Digital Servo Block Master Clock (MCK).

	XT1D	XT2D	XT4D	Frequency division ratio
*	0	0	0	According to XTSL
	1	—	—	1/1
	0	1	—	1/2
	0	0	1	1/4

\*: preset, —: don't care

**DRR2 to DRR0:** Partially clears the Data RAM values (0 write).  
The following values are cleared when 1 (on) respectively; default = 0

DRR2: M08, M09, M0A

DRR1: M00, M01, M02

DRR0: M00, M01, M02 only when LOCK = low

**Note)** Set DRR1 and DRR0 on for 50μs or more.

**ASFG:** When vibration detection is performed during anti-shock circuit operation, the FCS servo filter is forcibly set to gain normal status.

On when 1; default when 0

**LPAS:** Built-in analog buffer low-current consumption mode

This mode reduces the total analog buffer current consumption for the VC, TE, SE and FE input analog buffers by using a single operational amplifier.

On when 1; default when 0

**Note)** When using this mode, first check whether each error signal is properly A/D converted using the data readout and the like.

**AGHF:** This halves the frequency of the internally generated sine wave during AGC.

**FTQ:** The slope of the output during focus search is 1/4 of the conventional output slope.

On when 1; default when 0 .

**ASOT:** The anti-shock signal, which is internally detected, is output from the ATSK pin.

Output when set to 1; default = 0

Vibration detection when a high signal is output for the anti-shock signal output.

**Description of Data Readout**

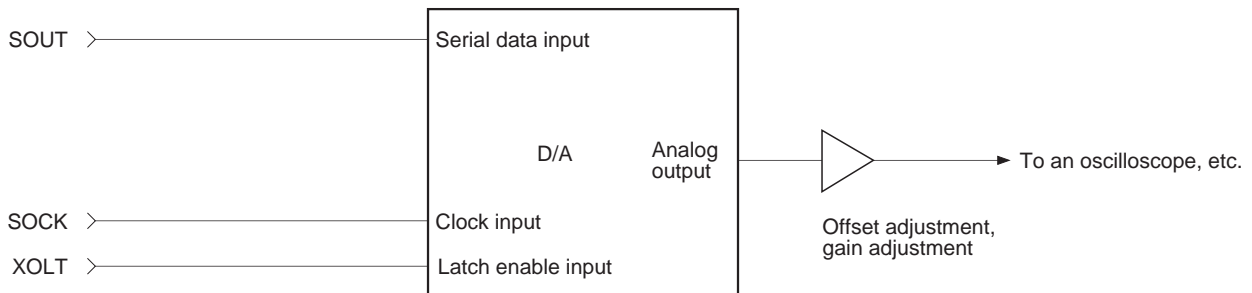
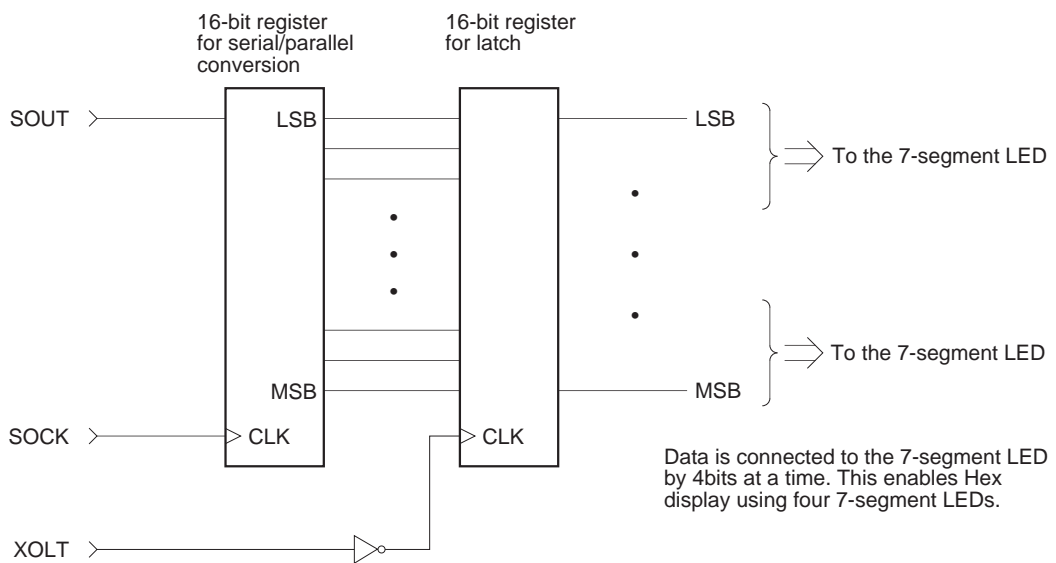
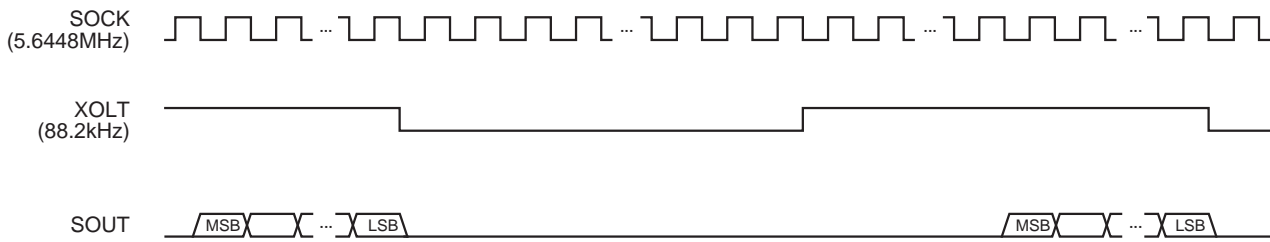

Waveforms can be monitored with an oscilloscope using a serial input-type D/A converter as shown above.

## § 5-19. List of Servo Filter Coefficients

## &lt;Coefficient Preset Value Table (1)&gt;

ADDRESS	DATA	CONTENTS
K00	E0	SLED INPUT GAIN
K01	81	SLED LOW BOOST FILTER A-H
K02	23	SLED LOW BOOST FILTER A-L
K03	7F	SLED LOW BOOST FILTER B-H
K04	6A	SLED LOW BOOST FILTER B-L
K05	10	SLED OUTPUT GAIN
K06	14	FOCUS INPUT GAIN
K07	30	SLED AUTO GAIN
K08	7F	FOCUS HIGH CUT FILTER A
K09	46	FOCUS HIGH CUT FILTER B
K0A	81	FOCUS LOW BOOST FILTER A-H
K0B	1C	FOCUS LOW BOOST FILTER A-L
K0C	7F	FOCUS LOW BOOST FILTER B-H
K0D	58	FOCUS LOW BOOST FILTER B-L
K0E	82	FOCUS PHASE COMPENSATE FILTER A
K0F	7F	FOCUS DEFECT HOLD GAIN
K10	4E	FOCUS PHASE COMPENSATE FILTER B
K11	32	FOCUS OUTPUT GAIN
K12	20	ANTI SHOCK INPUT GAIN
K13	30	FOCUS AUTO GAIN
K14	80	HPTZC / Auto Gain HIGH PASS FILTER A
K15	77	HPTZC / Auto Gain HIGH PASS FILTER B
K16	80	ANTI SHOCK HIGH PASS FILTER A
K17	77	HPTZC / Auto Gain LOW PASS FILTER B
K18	00	Fix*
K19	F1	TRACKING INPUT GAIN
K1A	7F	TRACKING HIGH CUT FILTER A
K1B	3B	TRACKING HIGH CUT FILTER B
K1C	81	TRACKING LOW BOOST FILTER A-H
K1D	44	TRACKING LOW BOOST FILTER A-L
K1E	7F	TRACKING LOW BOOST FILTER B-H
K1F	5E	TRACKING LOW BOOST FILTER B-L
K20	82	TRACKING PHASE COMPENSATE FILTER A
K21	44	TRACKING PHASE COMPENSATE FILTER B
K22	18	TRACKING OUTPUT GAIN
K23	30	TRACKING AUTO GAIN
K24	7F	FOCUS GAIN DOWN HIGH CUT FILTER A
K25	46	FOCUS GAIN DOWN HIGH CUT FILTER B
K26	81	FOCUS GAIN DOWN LOW BOOST FILTER A-H
K27	3A	FOCUS GAIN DOWN LOW BOOST FILTER A-L
K28	7F	FOCUS GAIN DOWN LOW BOOST FILTER B-H
K29	66	FOCUS GAIN DOWN LOW BOOST FILTER B-L
K2A	82	FOCUS GAIN DOWN PHASE COMPENSATE FILTER A
K2B	44	FOCUS GAIN DOWN DEFECT HOLD GAIN
K2C	4E	FOCUS GAIN DOWN PHASE COMPENSATE FILTER B
K2D	1B	FOCUS GAIN DOWN OUTPUT GAIN
K2E	00	NOT USED
K2F	00	NOT USED

\* Fix indicates that normal preset values should be used.

&lt;Coefficient Preset Value Table (2)&gt;

ADDRESS	DATA	CONTENTS
K30	80	SLED INPUT GAIN (Only when TRK Gain Up2 is accessed with SFSK = 1.)
K31	66	ANTI SHOCK LOW PASS FILTER B
K32	00	NOT USED
K33	7F	ANTI SHOCK HIGH PASS FILTER B-H
K34	6E	ANTI SHOCK HIGH PASS FILTER B-L
K35	20	ANTI SHOCK FILTER COMPARATE GAIN
K36	7F	TRACKING GAIN UP2 HIGH CUT FILTER A
K37	3B	TRACKING GAIN UP2 HIGH CUT FILTER B
K38	80	TRACKING GAIN UP2 LOW BOOST FILTER A-H
K39	44	TRACKING GAIN UP2 LOW BOOST FILTER A-L
K3A	7F	TRACKING GAIN UP2 LOW BOOST FILTER B-H
K3B	77	TRACKING GAIN UP2 LOW BOOST FILTER B-L
K3C	86	TRACKING GAIN UP PHASE COMPENSATE FILTER A
K3D	0D	TRACKING GAIN UP PHASE COMPENSATE FILTER B
K3E	57	TRACKING GAIN UP OUTPUT GAIN
K3F	00	NOT USED
K40	04	TRACKING HOLD FILTER INPUT GAIN
K41	7F	TRACKING HOLD FILTER A-H
K42	7F	TRACKING HOLD FILTER A-L
K43	79	TRACKING HOLD FILTER B-H
K44	17	TRACKING HOLD FILTER B-L
K45	6D	TRACKING HOLD FILTER OUTPUT GAIN
K46	00	TRACKING HOLD FILTER INPUT GAIN (Only when TRK Gain Up2 is accessed with THSK = 1.)
K47	00	NOT USED
K48	02	FOCUS HOLD FILTER INPUT GAIN
K49	7F	FOCUS HOLD FILTER A-H
K4A	7F	FOCUS HOLD FILTER A-L
K4B	79	FOCUS HOLD FILTER B-H
K4C	17	FOCUS HOLD FILTER B-L
K4D	54	FOCUS HOLD FILTER OUTPUT GAIN
K4E	00	NOT USED
K4F	00	NOT USED

**§ 5-20. Filter Composition**

The internal filter composition is shown below.  
 K\*\* and M\*\* indicate coefficient RAM and Data RAM address values respectively.

**FCS Servo Gain Normal  $f_s = 88.2\text{kHz}$**

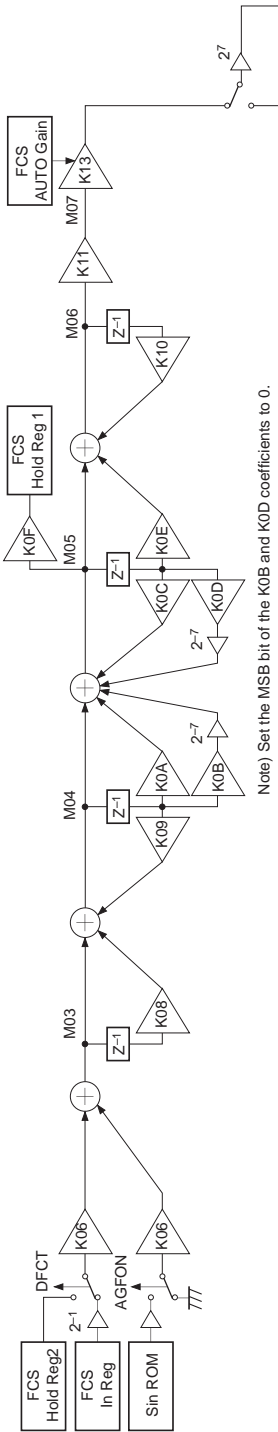

**FCS Servo Gain Down  $f_s = 88.2\text{kHz}$**

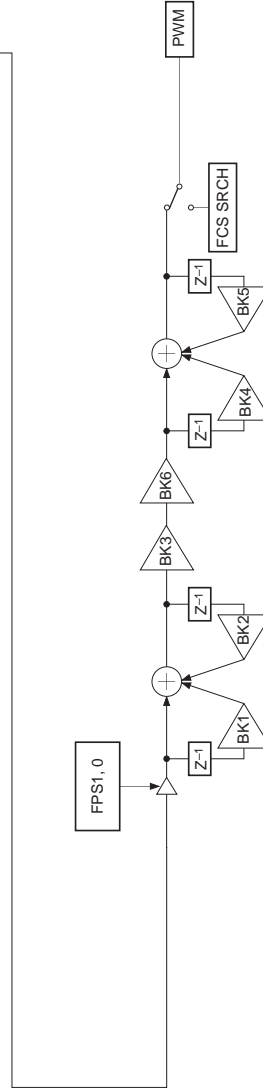
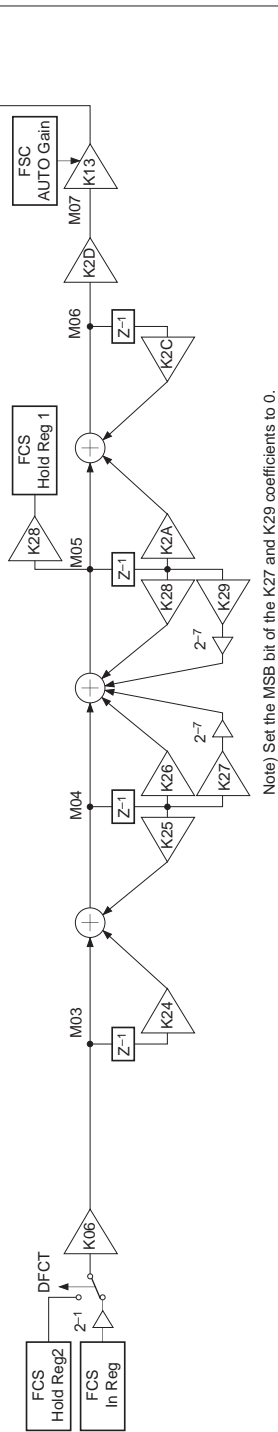

**TRK Servo Gain Normal fs = 88.2kHz**

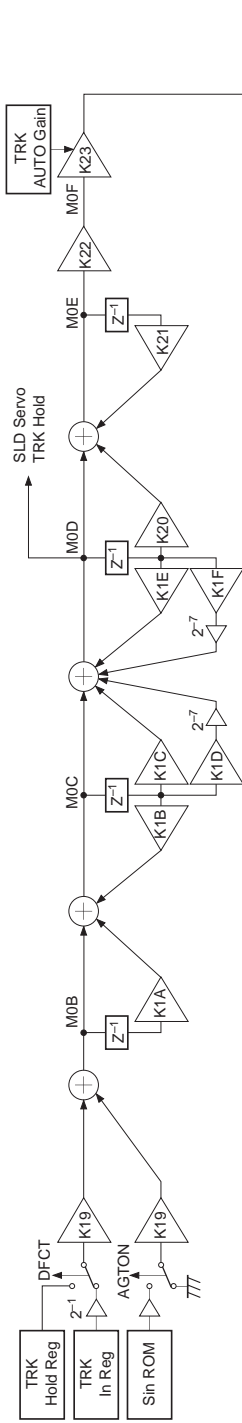

Note) Set the MSB bit of the K1D and K1F coefficients to 0.

**TRK Servo Gain Up 1 fs = 88.2kHz**

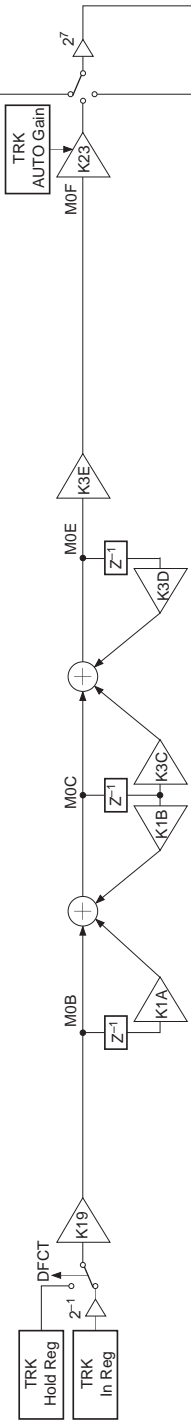

Note) Set the MSB bit of the K39 and K3B coefficients to 0.

**TRK Servo Gain Up 2 fs = 88.2kHz**

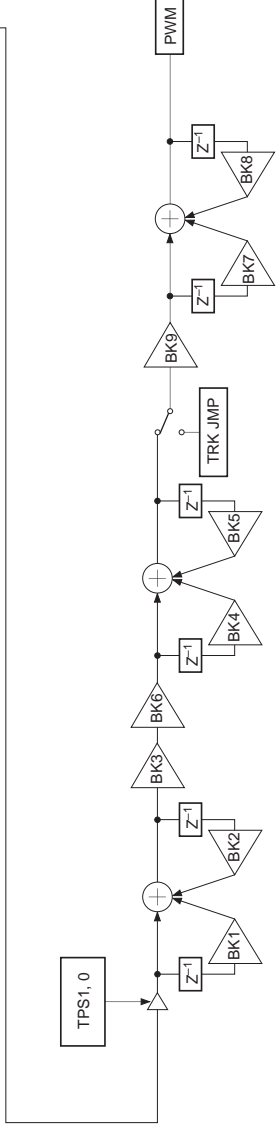
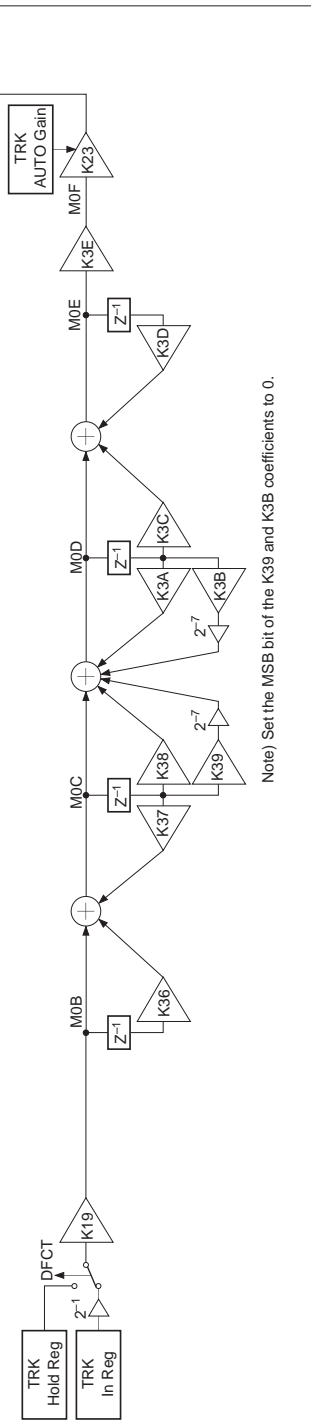



**FCS Servo Gain Normal  $f_s = 88.2\text{kHz}$ , during quasi double accuracy (Ex.: \$3EAXX0)**

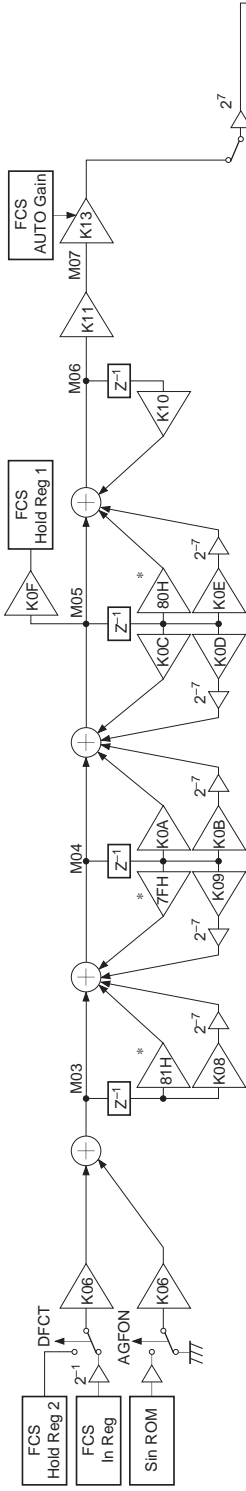

Note) Set the MSB bit of the K0B and K0D coefficients during normal operation, and of the K0B, K09 and K0E coefficients during quasi double accuracy to 0.

**FCS Servo Gain Normal  $f_s = 88.2\text{kHz}$ , during quasi double accuracy (Ex.: \$3E5XX0)**

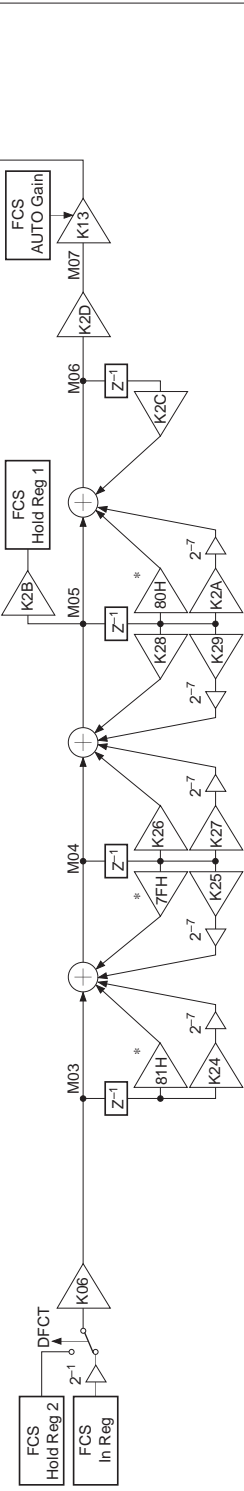

Note) Set the MSB bit of the K27 and K29 coefficients during normal operation, and of the K24, K25 and K2A coefficients during quasi double accuracy to 0.

\* 81H, 7FH and 80H are each Hex display 8-bit fixed values when set to quasi double accuracy.

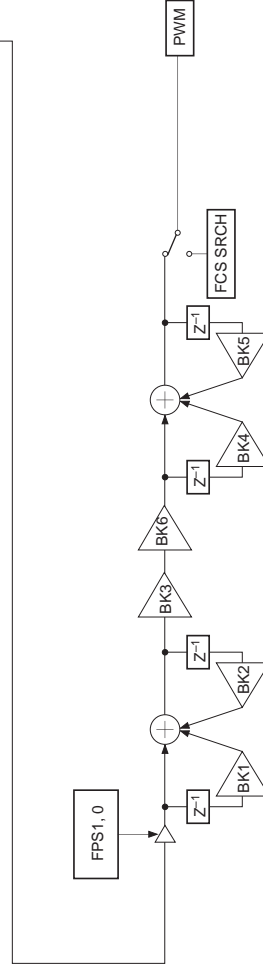

**TRK Servo Gain Normal  $f_s = 88.2\text{kHz}$ , during quasi double accuracy (Ex.: \$3EXAX0)**

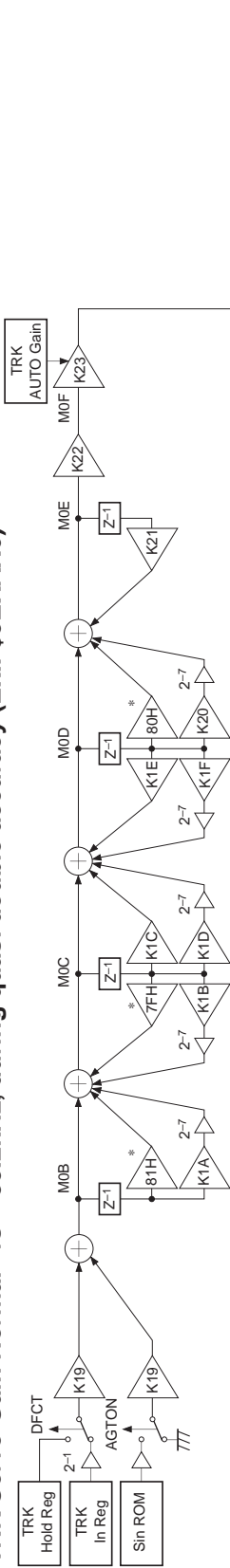

Note) Set the MSB bit of the K1D and K1F coefficients during normal operation, and of the K1A, K1B and K20 coefficients during quasi double accuracy to 0.

**TRK Servo Gain up1  $f_s = 88.2\text{kHz}$ , during quasi double accuracy (Ex.: \$3EX5X0)**

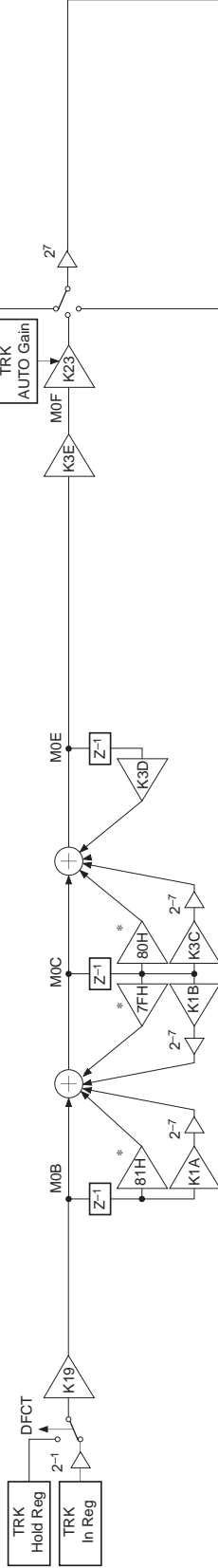

Note) Set the MSB bit of the K1A, K1B and K3C coefficients during quasi double accuracy to 0.

**TRK Servo Gain up2  $f_s = 88.2\text{kHz}$ , during quasi double accuracy (Ex.: \$3EX5X0)**

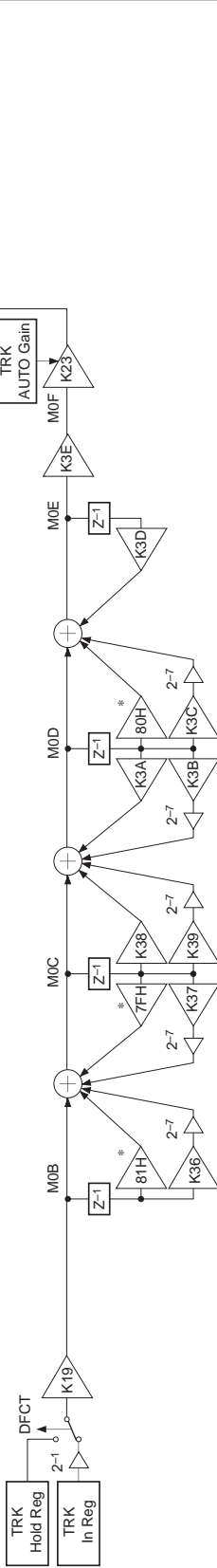

Note) Set the MSB bit of the K39 and K3B coefficients during normal operation, and of the K36, K37 and K3C coefficients during quasi double accuracy to 0.

\* 81H, 7FH and 80H are each Hex display 8-bit fixed values when set to quasi double accuracy.

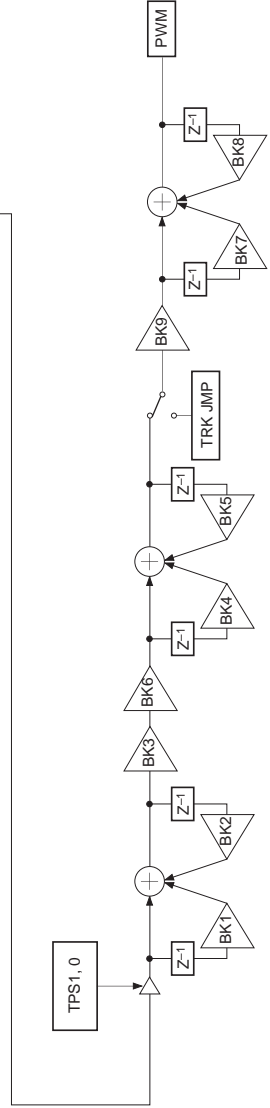

**SLD Servo fs = 345Hz**

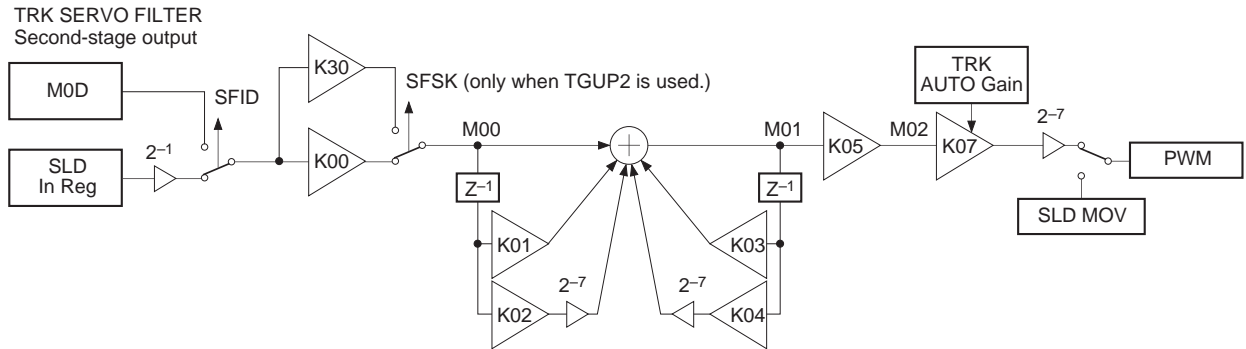

**Note)** Set the MSB bit of the K02 and K04 coefficients to 0.

**HPTZC/Auto Gain fs = 88.2kHz**

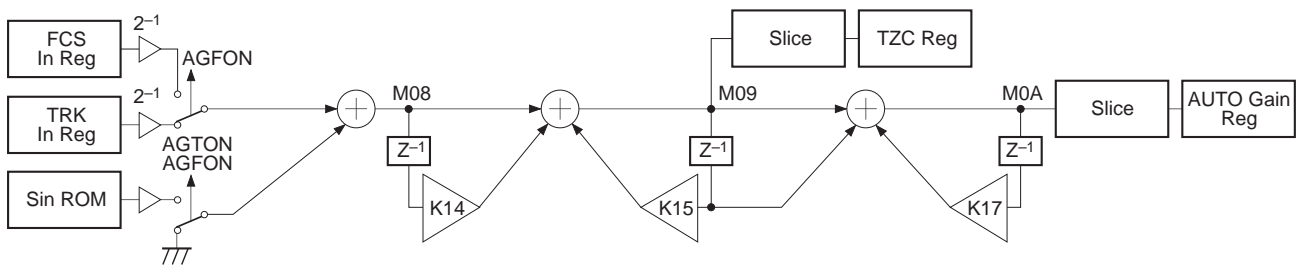

**Anti Shock  $f_s = 88.2\text{kHz}$**

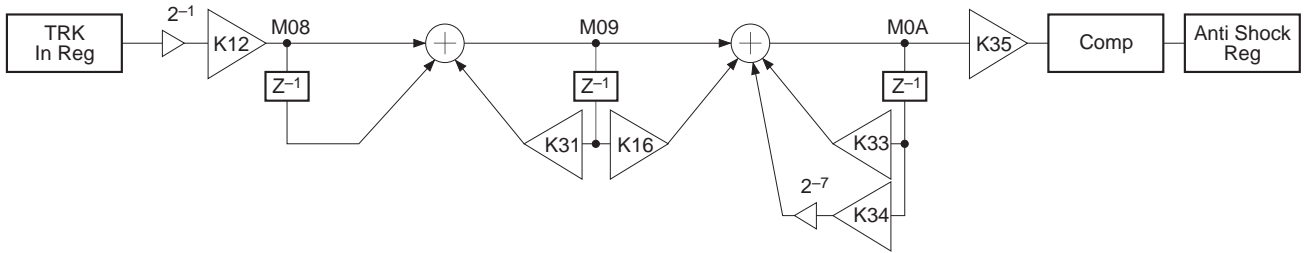

**Note)** Set the MSB bit of the K34 coefficient to 0.  
The comparator level is 1/16 the maximum amplitude of the comparator input.

**AVRG  $f_s = 88.2\text{kHz}$**

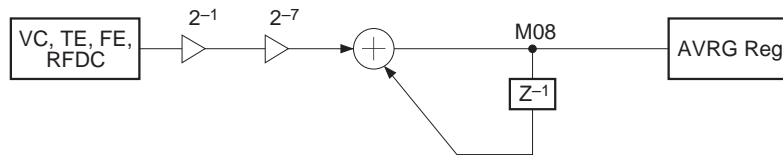

**TRK Hold  $f_s = 345\text{Hz}$**

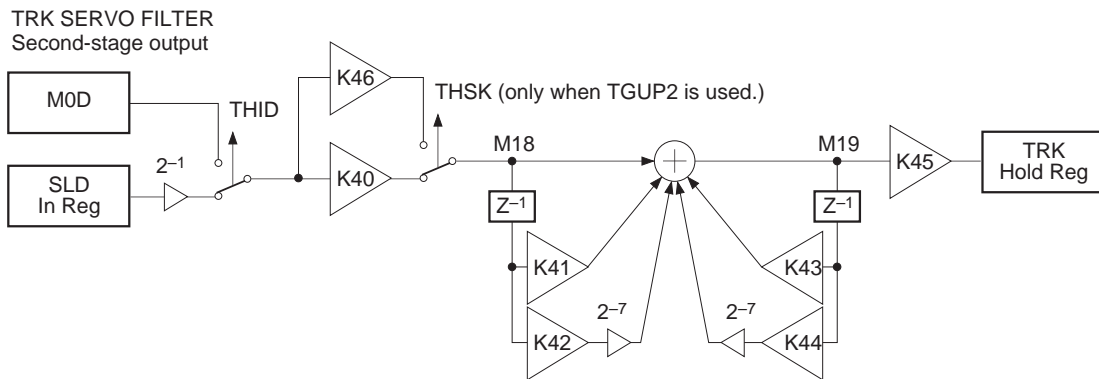

**Note)** Set the MSB bit of the K42 and K44 coefficients to 0.

**FCS Hold  $f_s = 345\text{Hz}$**

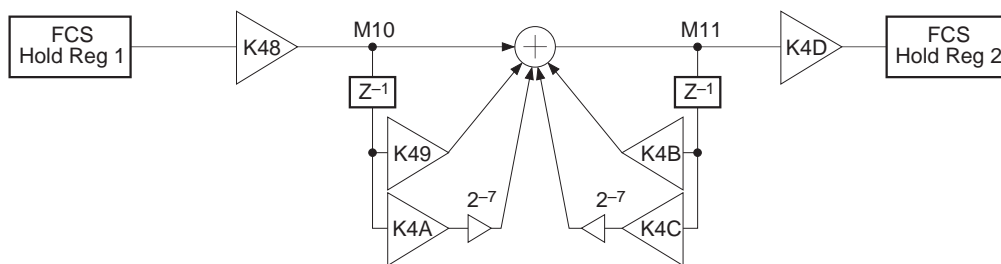

**Note)** Set the MSB bit of the K4A and K4C coefficients to 0.

§ 5-21. TRACKING and FOCUS Frequency Response

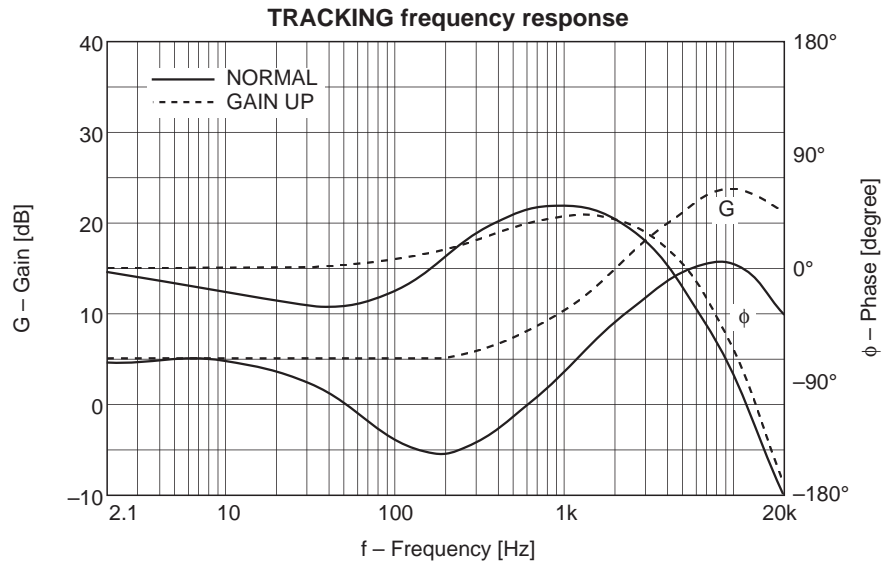

When using the preset coefficients with the boost function off.

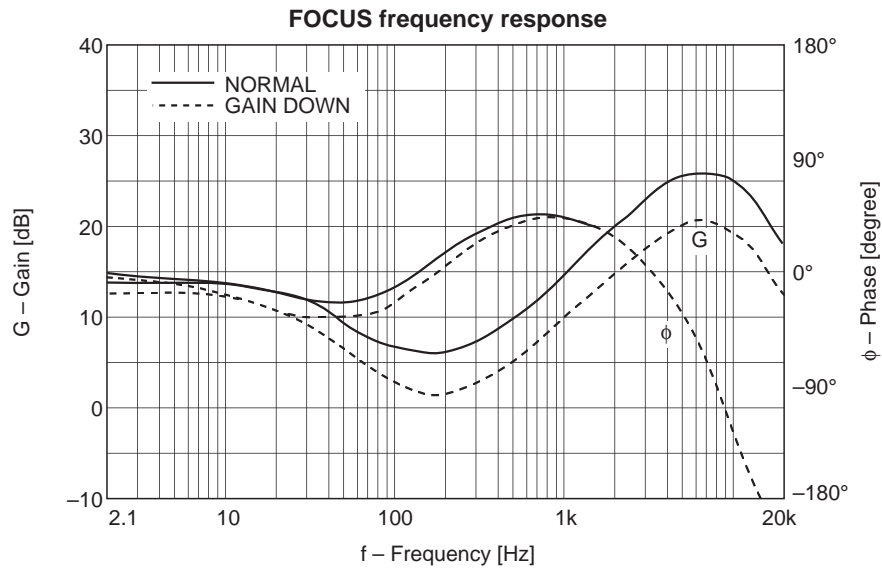

When using the preset coefficients with the boost function off.

[6] Application Circuit

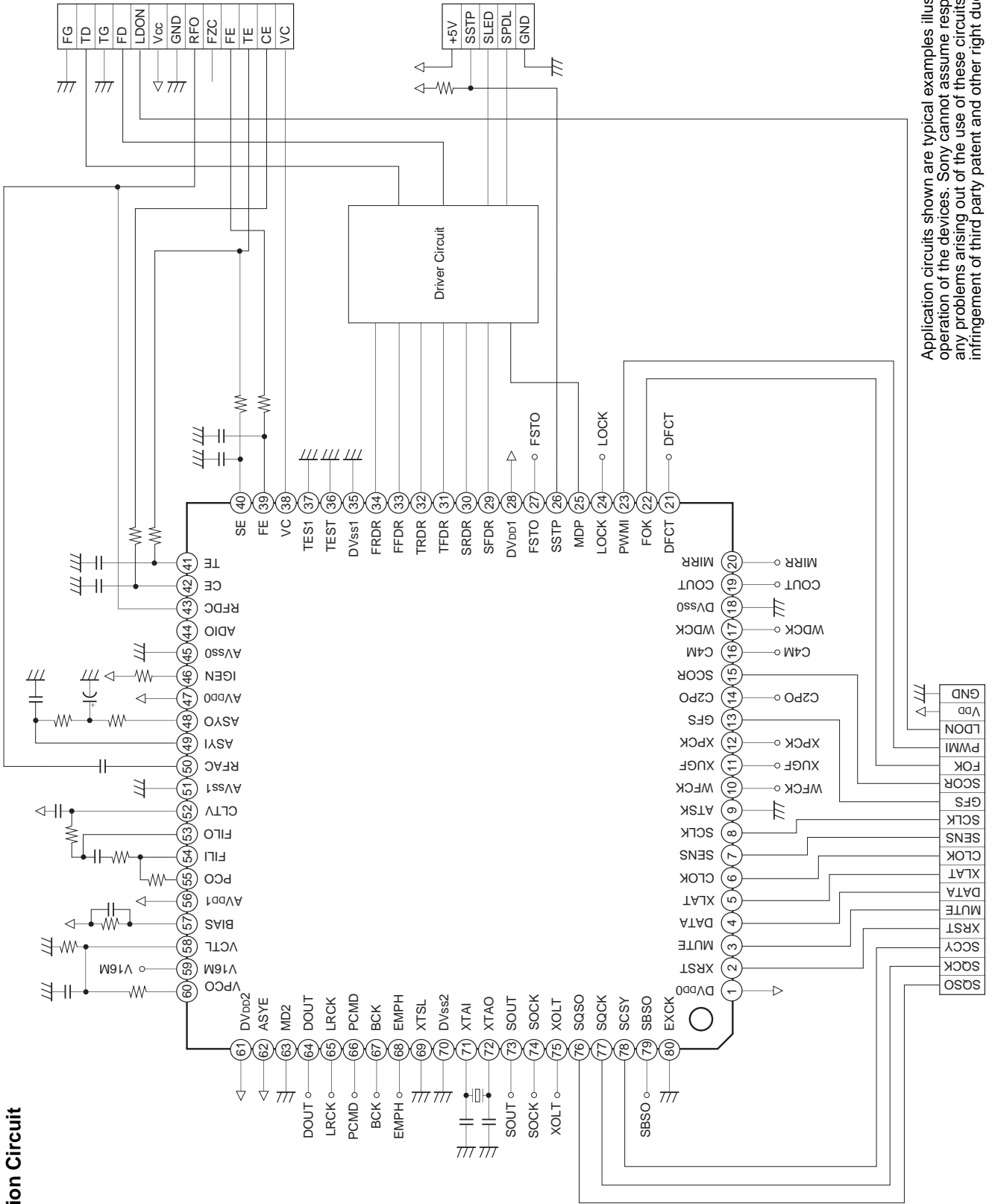

Application circuits shown are typical examples illustrating the operation of the devices. Sony cannot assume responsibility for any problems arising out of the use of these circuits or for any infringement of third party patent and other right due to same.

Package Outline Unit: mm

80PIN QFP (PLASTIC)

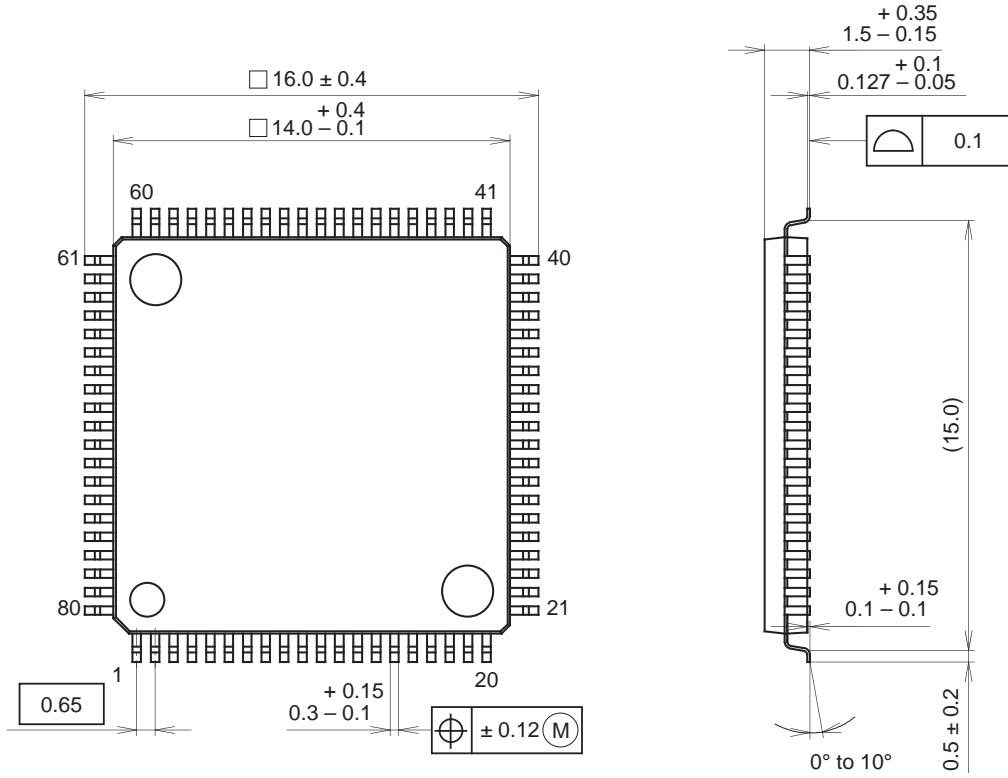

PACKAGE STRUCTURE

SONY CODE	QFP-80P-L03
EIAJ CODE	LQFP080-P-1414
JEDEC CODE	_____

PACKAGE MATERIAL	EPOXY RESIN
LEAD TREATMENT	SOLDER PLATING
LEAD MATERIAL	42/COPPER ALLOY
PACKAGE MASS	0.6g