

GaAs N-channel Dual-Gate MES FET

Description

The SGM2016AN is an N-channel dual-gate GaAs MES FET for UHF-band low-noise amplification. This FET is suitable for a wide range of applications including UHF TV tuners, cellular/cordless phone, and DBS IF amplifiers.

Features

- Ultra-small package
- Low voltage operation
- Low noise NF = 1.2dB (typ.) at 900MHz
- High gain Ga = 21dB (typ.) at 900MHz
- High stability
- Built-in gate protection diode

Application

UHF-band high-frequency amplifier, mixer, and oscillator

Structure

GaAs, N-channel, dual-gate metal semiconductor field-effect transistor

Absolute Maximum Ratings (Ta = 25°C)

• Drain to source voltage	V _{DSX}	12	V
• Gate 1 to source voltage	V _{G1S}	-5	V
• Gate 2 to source voltage	V _{G2S}	-5	V
• Drain current	I _D	55	mA
• Allowable power dissipation	P _D	100	mW
• Channel temperature	T _{ch}	125	°C
• Storage temperature	T _{stg}	-55 to +150	°C

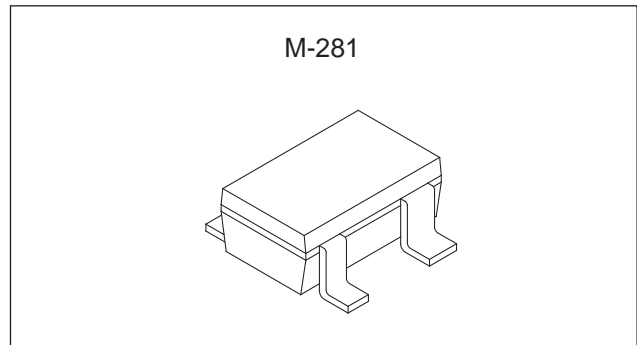

Sony reserves the right to change products and specifications without prior notice. This information does not convey any license by any implication or otherwise under any patents or other right. Application circuits shown, if any, are typical examples illustrating the operation of the devices. Sony cannot assume responsibility for any problems arising out of the use of these circuits.

Electrical Characteristics

(Ta = 25°C)

Item	Symbol	Conditions	Min.	Typ.	Max.	Unit
Drain cut-off current	I_{DSX}	$V_{DS} = 12V$ $V_{G1S} = -4V$ $V_{G2S} = 0V$			50	μA
Gate 1 to source current	I_{G1SS}	$V_{G1S} = -4.5V$ $V_{G2S} = 0V$ $V_{DS} = 0V$			-8	μA
Gate 2 to source current	I_{G2SS}	$V_{G2S} = -4.5V$ $V_{G1S} = 0V$ $V_{DS} = 0V$			-8	μA
Drain saturation current	I_{DSS}	$V_{DS} = 5V$ $V_{G1S} = 0V$ $V_{G2S} = 0V$	10		35	mA
Gate 1 to source cut-off voltage	$V_{G1S} (OFF)$	$V_{DS} = 5V$ $I_D = 100\mu A$ $V_{G2S} = 0V$			-2.5	V
Gate 2 to source cut-off voltage	$V_{G2S} (OFF)$	$V_{DS} = 5V$ $I_D = 100\mu A$ $V_{G1S} = 0V$			-2.5	V
Forward transfer admittance	gm	$V_{DS} = 5V$ $I_D = 10mA$ $V_{G2S} = 1.5V$ $f = 1kHz$	20	30		ms
Input capacitance	C_{iss}	$V_{DS} = 5V$ $I_D = 10mA$ $V_{G2S} = 1.5V$		0.9	2.0	pF
Feedback capacitance	C_{rss}	$f = 1MHz$		25	40	fF
Noise figure	NF	$V_{DS} = 5V$ $I_D = 10mA$ $V_{G2S} = 1.5V$		1.2	2.0	dB
NF associated gain	Ga	$f = 900MHz$	17	21		dB

Typical Characteristics (Ta = 25°C)

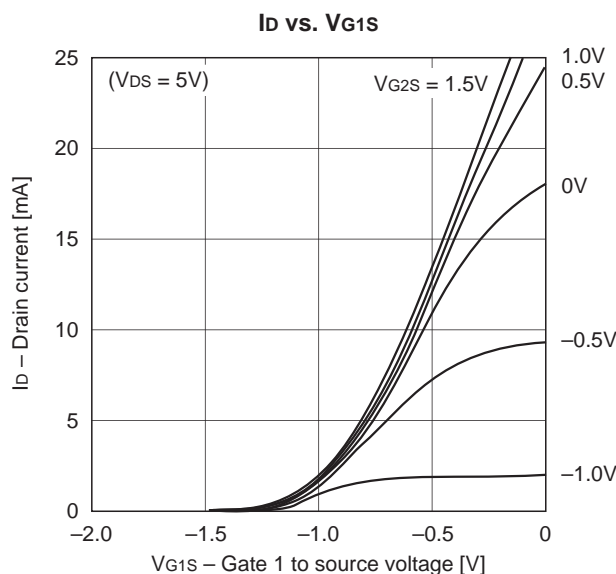
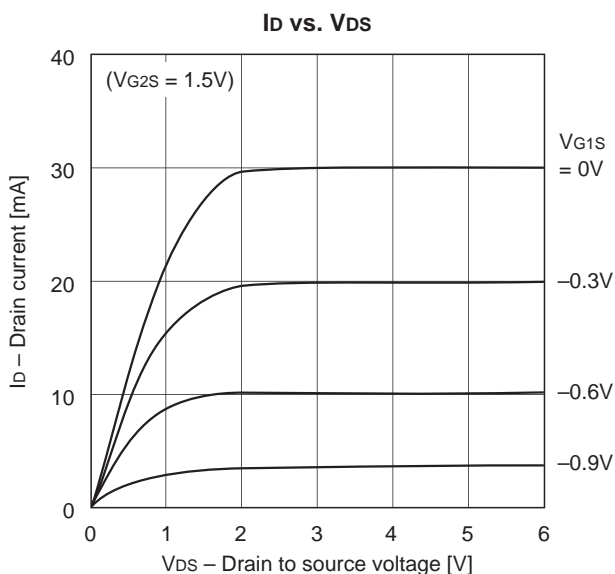

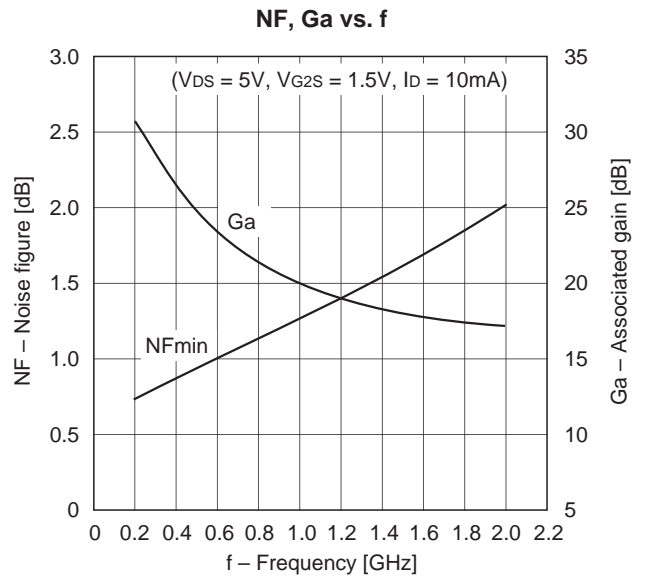
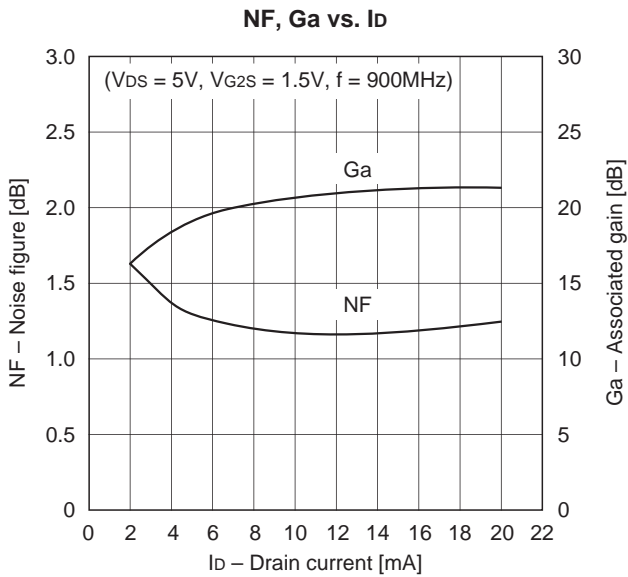
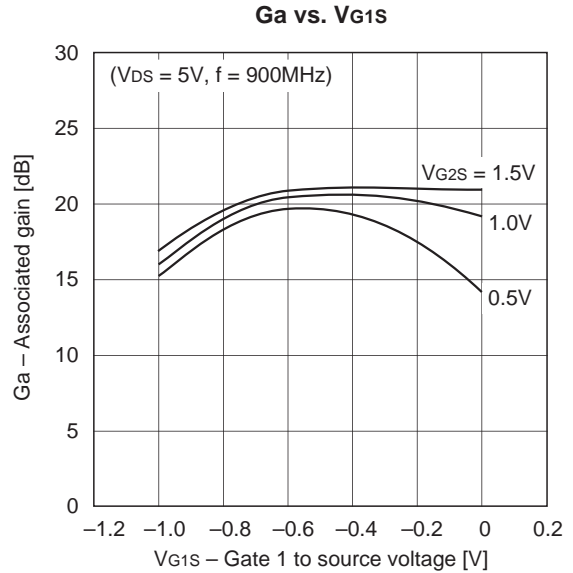
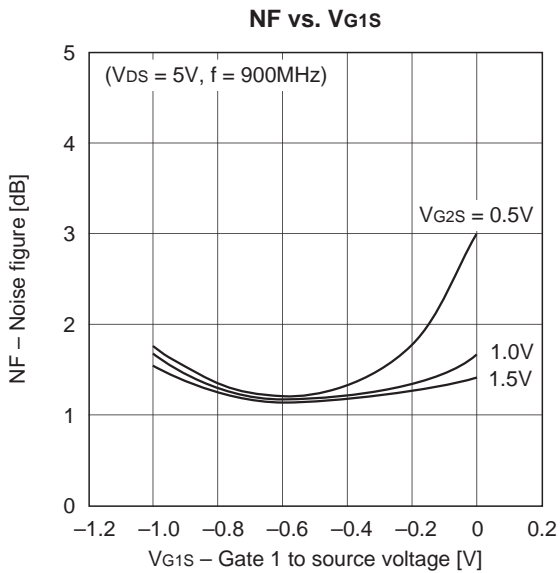
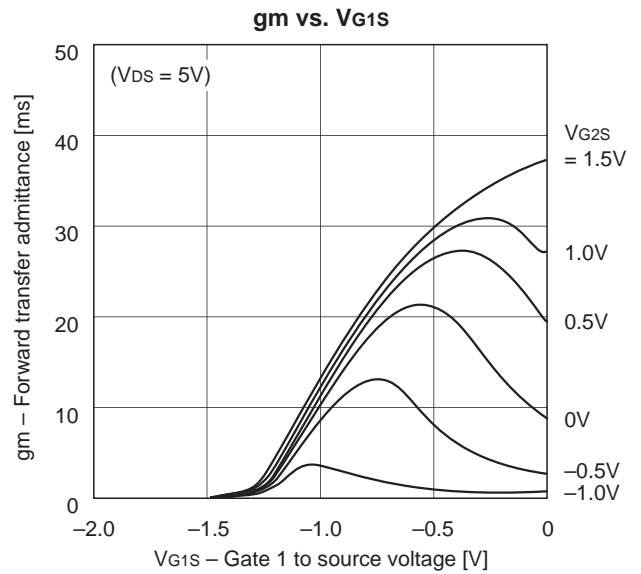
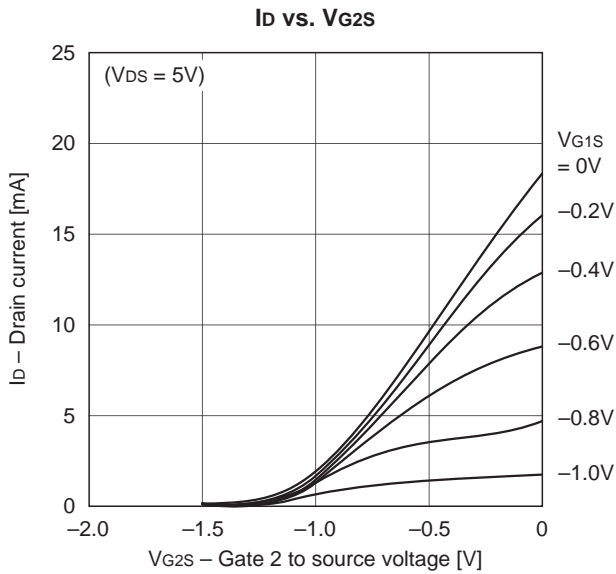

S-parameter vs. Frequency Characteristics ($V_{DS} = 5V$, $V_{G2S} = 1.5V$, $I_D = 10mA$) $(Z_0 = 50\Omega)$

f (MHz)	S11		S21		S12		S22	
	MAG	ANG	MAG	ANG	MAG	ANG	MAG	ANG
100	0.999	-3.8	2.521	174.2	0.002	95.0	0.969	-1.3
200	0.994	-7.9	2.515	168.1	0.003	87.9	0.966	-3.0
300	0.981	-11.8	2.499	162.3	0.005	83.6	0.964	-4.2
400	0.969	-16.0	2.480	156.3	0.006	77.7	0.961	-6.1
500	0.952	-20.0	2.451	150.6	0.007	82.1	0.957	-7.2
600	0.935	-24.1	2.420	144.8	0.009	76.3	0.955	-8.8
700	0.917	-27.8	2.391	139.4	0.009	76.8	0.955	-9.9
800	0.896	-31.3	2.362	133.9	0.010	78.7	0.954	-11.5
900	0.877	-34.7	2.331	128.5	0.011	74.4	0.954	-12.8
1000	0.850	-38.0	2.294	122.9	0.012	82.6	0.953	-14.4
1100	0.822	-40.9	2.254	117.7	0.012	79.3	0.952	-15.6
1200	0.797	-44.0	2.216	112.4	0.012	72.4	0.949	-17.2
1300	0.769	-46.8	2.182	107.3	0.013	79.0	0.947	-18.2
1400	0.744	-49.7	2.153	102.1	0.013	81.5	0.946	-20.0
1500	0.717	-52.4	2.118	96.9	0.013	80.3	0.945	-21.3
1600	0.692	-54.9	2.076	91.8	0.013	83.7	0.945	-22.9
1700	0.668	-57.5	2.038	86.6	0.013	90.1	0.945	-24.1
1800	0.641	-59.6	2.005	81.4	0.013	98.4	0.945	-25.8
1900	0.617	-61.6	1.963	76.4	0.013	109.0	0.945	-27.3
2000	0.589	-63.4	1.929	71.5	0.013	113.0	0.945	-28.7

Noise Figure Characteristics ($V_{DS} = 5V$, $V_{G2S} = 1.5V$, $I_D = 10mA$)

f (MHz)	NFmin (dB)	Gamma Optimum		Rn (Ω)
		ANG	MAG	
200	0.73	0.94	7.5	40.0
300	0.79	0.90	10.8	39.5
400	0.85	0.87	13.9	39.0
500	0.92	0.84	16.8	38.5
600	0.99	0.81	19.5	37.9
700	1.05	0.78	22.0	37.4
800	1.11	0.75	24.5	36.8
900	1.18	0.72	26.8	36.1
1000	1.25	0.70	29.1	35.5
1100	1.32	0.67	31.4	34.8
1200	1.39	0.65	33.8	34.1
1300	1.46	0.63	36.1	33.4
1400	1.53	0.60	38.6	32.6
1500	1.61	0.58	41.2	31.9
1600	1.68	0.56	43.9	31.0
1700	1.76	0.54	46.8	30.2
1800	1.84	0.52	50.0	29.3
1900	1.92	0.50	53.4	28.5
2000	2.00	0.48	57.0	27.5

Package Outline Unit: mm

SGM2016AN

M-281

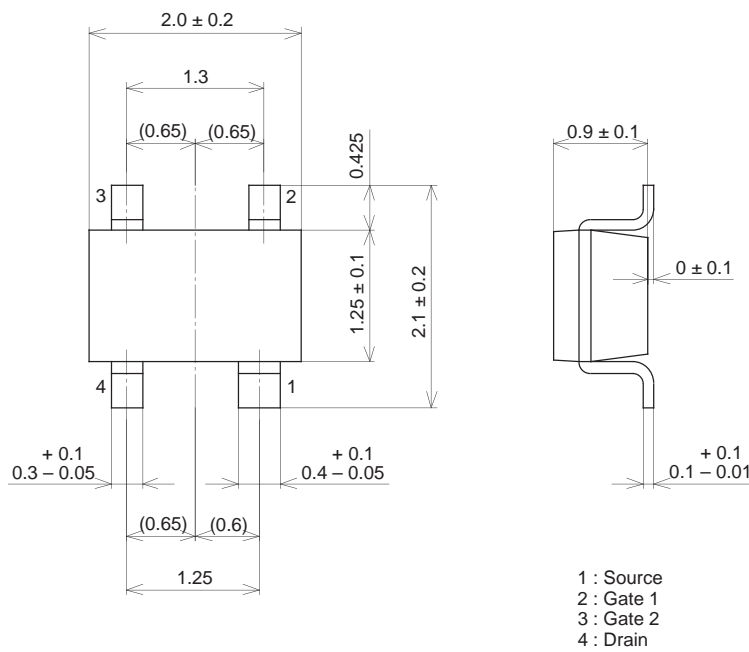

SONY CODE	M-281
EIAJ CODE	—
JEDEC CODE	—

PACKAGE MATERIAL	EPOXY RESIN
LEAD TREATMENT	SOLDER PLATING
LEAD MATERIAL	COPPER
PACKAGE WEIGHT	0.1g