



## Product Description

The Stanford Microdevices' SLX-2043 is a low noise amplifier module operating in the 1700 - 2500 MHz frequency band. This device has been optimized to serve high linearity basestation applications where a high intercept point is required with low noise figure. The SLX-2043 uses PHEMT device technology, internal bias circuitry, and proven ceramic module technology to yield a high performance product with proven reliability. Internal RF matching is also included on both the input and output to provide an easy to implement, unconditionally stable, 50 ohm circuit block.

## SLX-2043

### 1700-2500 MHz High Linearity Low Noise Amplifier Module



Noise Figure

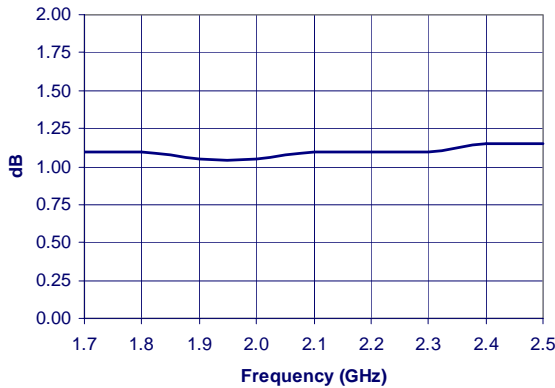

## Product Features

- **NF = 1.1dB**
- **IIP<sub>3</sub> = +19dBm**
- **Gain = 15dB**
- **50Ω input/output match**
- **Single supply operation**

## Applications

- **PCS, TDMA, CDMA, WCDMA receivers**

## Key Specifications

Symbol	Parameters	Test Conditions ( $Z_0=50\Omega$ , $T=25^\circ\text{C}$ , $V_D=4\text{V}$ )	Unit	Min.	Typ.	Max.
	Frequency Range		MHz	1700		2500
IIP <sub>3</sub>	Input Third Order Intercept Point	Power out per tone = 6dBm	dBm		+19	
OIP <sub>3</sub>	Third Order Intercept Point	Power out per tone = 6dBm	dBm		+34	
NF	Noise Figure		dB		1.1	1.2
S <sub>21</sub>	Small Signal Gain		dB		15	
P <sub>1dB</sub>	Output Power	@ 1dB Compression	dBm		20	
S <sub>11</sub>	Input VSWR		—		1.8:1	
S <sub>22</sub>	Output VSWR		—		1.8:1	
V <sub>D</sub>	Device Voltage		V	+3.5	+4.0	+4.5
I <sub>D</sub>	Device Current		mA	90	105	120
R <sub>thj-c</sub>	Thermal Resistance	(junction-case)	°C/W		60	

The information provided herein is believed to be reliable at press time. Stanford Microdevices assumes no responsibility for inaccuracies or omissions. Stanford Microdevices assumes no responsibility for the use of this information, and all such information shall be entirely at the user's own risk. Prices and specifications are subject to change without notice. No patent rights or licenses to any of the circuits described herein are implied or granted to any third party. Stanford Microdevices does not authorize or warrant any Stanford Microdevices product for use in life-support devices and/or systems.

Copyright 2000 Stanford Microdevices, Inc. All worldwide rights reserved.

522 Almanor Ave., Sunnyvale, CA 94086

Phone: (800) SMI-MMIC

<http://www.stanfordmicro.com>

**Absolute Maximum Ratings**

Parameters	Value	Unit
Supply Current	150	mA
Device Voltage	5.0	V
Operating Temperature	-40 to +85	°C
Maximum Input Power	+17	dBm
Storage Temperature Range	-65 to +150	°C
Operating Junction Temperature	+150	°C

Operation of this device above any one of these parameters may cause permanent damage.

Bias conditions should also satisfy the following expression:  $I_D V_D (\text{max}) < (T_J - T_{OP})/R_{th, j-l}$

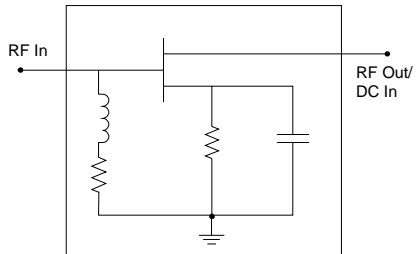
Pin #	Function	Description	Device Schematic
1	RF In	RF input pin. This pin requires the use of an external DC blocking capacitor chosen for the frequency of operation.	
2	RF Out/ Bias	RF output and bias pin. Bias should be supplied to this pin through an external RF choke inductor. Because DC biasing is present on this pin, a DC blocking capacitor should be used in most applications (see application schematic). The supply side of the bias network should be well bypassed.	
3 Package Backside	GND	Connection to ground. For best performance use via holes as shown in recommended PCB layout to reduce inductance and to provide adequate thermal path.	

Reference Designators	Function	Value
C1, C2	DC Blocking	10 pF
C3	Decoupling	220 pF
C4	Decoupling	0.01 uF
L1	AC Blocking	47 nH

**Application Schematic**

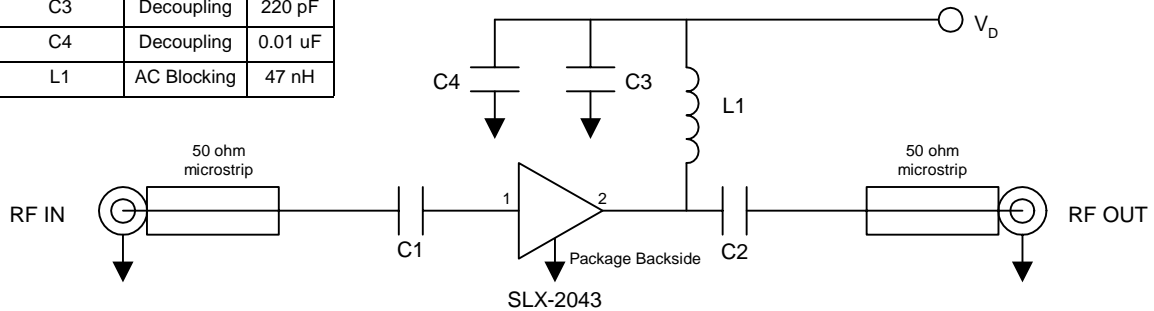

**S21, T = 25°C**

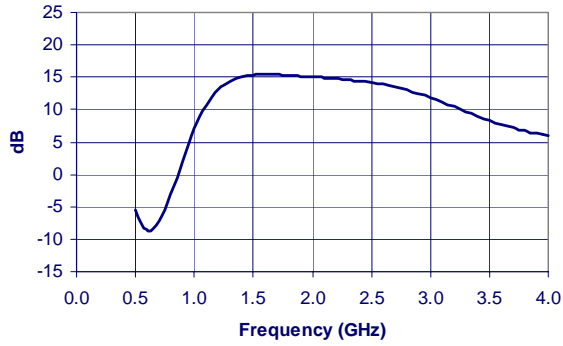

**S12, T = 25°C**

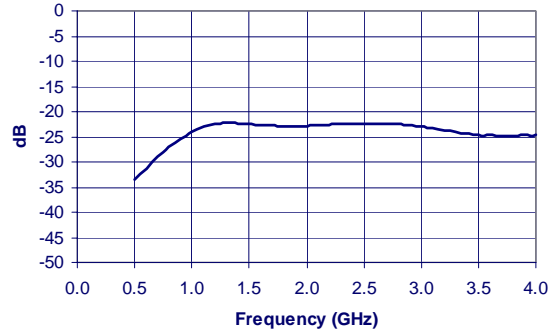

**S11, T = 25°C**

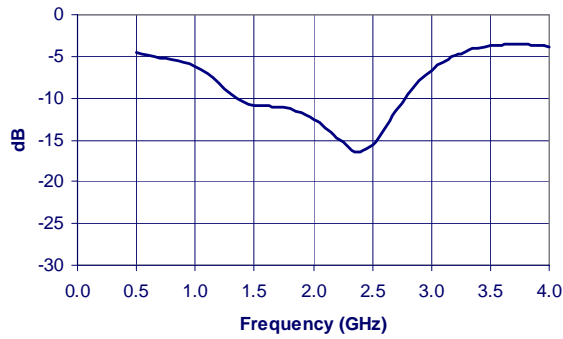

**S22, T = 25°C**

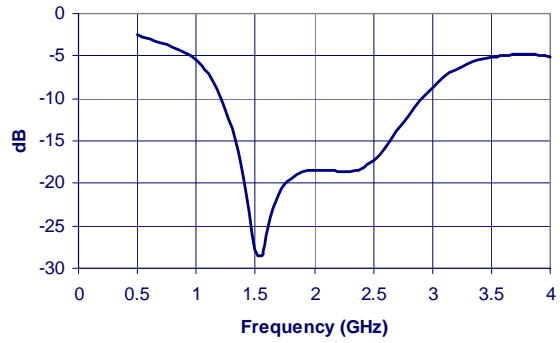

**Noise Figure**

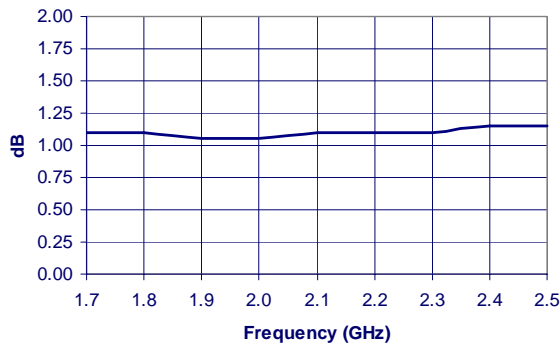

**Output IP3**

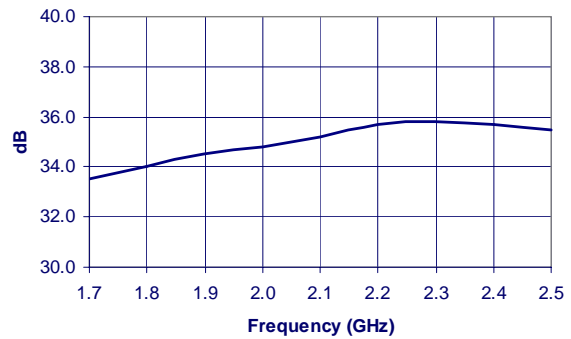



**Caution: ESD Sensitive**  
 Appropriate precaution in handling, packaging and testing devices must be observed.

**Part Number Ordering Information**

Part Number	Reel Size	Devices/Reel
SLX-2043	TBD	TBD

**Part Symbolization**

The part will be symbolized with a "TBD" marking designator on the top surface of the package.

**Package Dimensions ("43" package)**

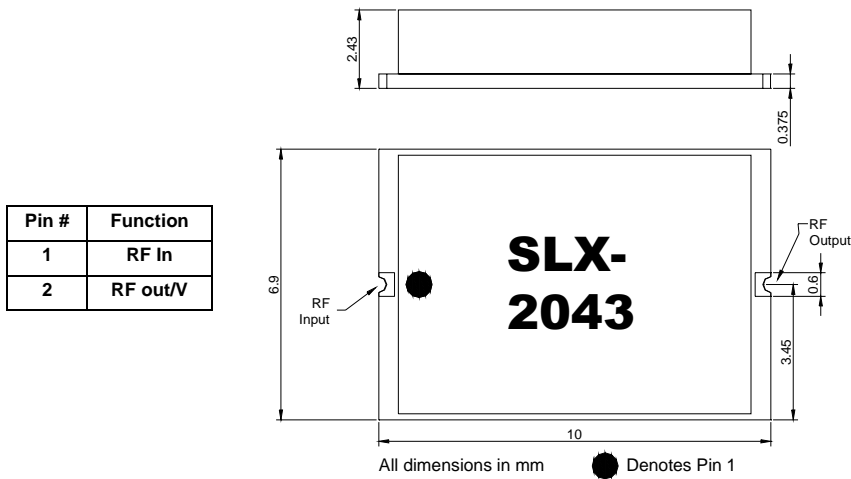

**Test PCB Pad Layout**

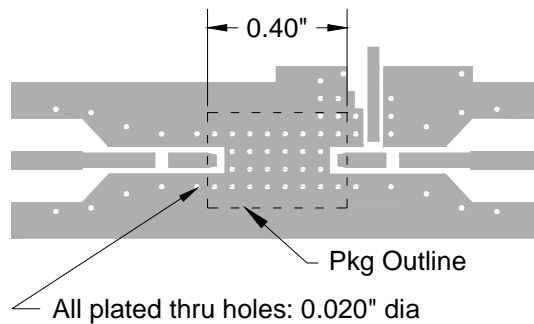

**Demo Test Board  
(Fully Assembled PCB)**

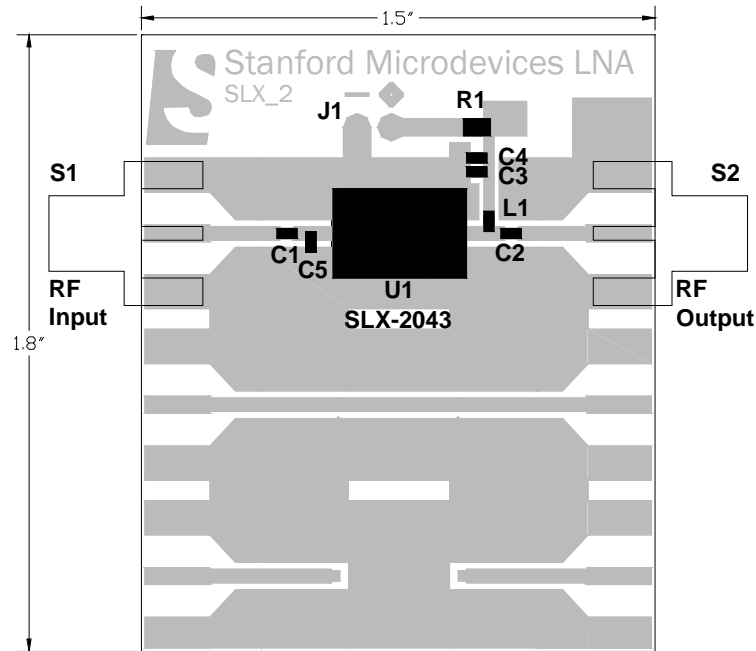

**Bill of Materials**

Component Designator	Value	Qty	Vendor	Part Number	Description
U1		1	SMDI	SLX-2043	High linearity low noise amplifier
S1, S2		2	Johnson Components	142-0701-851	SMA side mount connector
C1, C2	10 pF	2	Kemet	C0603C100J5GAC	0603 capacitor (critical)
C3	220 pF	1	Kemet	C0603C221J5GAC	0603 capacitor
C4	0.01 uF	1	Kemet	C0603C103K5RAC	0603 capacitor
C5	0.5pF	1	Kemet	C0402C508C5GAC	0402 capacitor (will not be required on production modules) (critical)
R1	0Ω	1	Panasonic	POOGCTND	0603 jumper
J1		1	Sullins	S1312-2-ND	2 pin header
L1	47 nH	1	TOKO	LL1608-F47NK	0603 inductor (critical)

The information provided herein is believed to be reliable at press time. Stanford Microdevices assumes no responsibility for inaccuracies or omissions. Stanford Microdevices assumes no responsibility for the use of this information, and all such information shall be entirely at the user's own risk. Prices and specifications are subject to change without notice. No patent rights or licenses to any of the circuits described herein are implied or granted to any third party. Stanford Microdevices does not authorize or warrant any Stanford Microdevices product for use in life-support devices and/or systems.  
Copyright 2000 Stanford Microdevices, Inc. All worldwide rights reserved.  
522 Almanor Ave., Sunnyvale, CA 94086 Phone: (800) SMI-MMIC <http://www.stanfordmicro.com>  
5 03/28/01 rev 8.0