

Product Description

Stanford Microdevices' SGA-3263 is a high performance SiGe Heterojunction Bipolar Transistor MMIC Amplifier. A Darlington configuration featuring 1 micron emitters provides high F_T and excellent thermal performance. The heterojunction increases breakdown voltage and minimizes leakage current between junctions. Cancellation of emitter junction non-linearities results in higher suppression of intermodulation products. At 850 MHz and 35mA, the SGA-3263 typically provides +26.2 dBm output IP3, 14.4 dB of gain, and +11.6 dBm of 1dB compressed power using a single positive voltage supply. Only 2 DC-blocking capacitors, a bias resistor and an optional RF choke are required for operation.

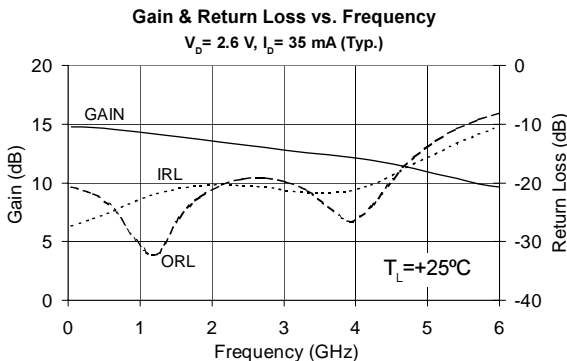

SGA-3263

DC-5500 MHz, Cascadable SiGe HBT MMIC Amplifier



Product Features

- High Gain : 13.6 dB at 1950 MHz
- Cascadable 50 Ohm
- Patented SiGe Technology
- Operates From Single Supply
- Low Thermal Resistance Package

Applications

- Cellular, PCS, CDPD
- Wireless Data, SONET
- Satellite

| Symbol | Parameter | Units | Frequency | Min. | Typ. | Max. |
|------------------|---|-------|-----------|------|------|------|
| G | Small Signal Gain | dB | 850 MHz | 13.0 | 14.4 | 15.8 |
| | | dB | 1950 MHz | | 13.6 | |
| | | dB | 2400 MHz | | 13.3 | |
| P _{1dB} | Output Power at 1dB Compression | dBm | 850 MHz | | 11.6 | |
| | | dBm | 1950 MHz | | 10.9 | |
| OIP ₃ | Output Third Order Intercept Point (Power out per tone = -5dBm) | dBm | 850 MHz | | 26.2 | |
| | | dBm | 1950 MHz | | 24.1 | |
| Bandwidth | Determined by Return Loss (<-10dB) | MHz | | | 5500 | |
| IRL | Input Return Loss | dB | 1950 MHz | | 20.3 | |
| ORL | Output Return Loss | dB | 1950 MHz | | 21.5 | |
| NF | Noise Figure | dB | 1950 MHz | | 3.8 | |
| V _D | Device Voltage | V | | 2.3 | 2.6 | 2.9 |
| R _{Th} | Thermal Resistance | °C/W | | | 255 | |

Test Conditions: $V_S = 5\text{ V}$ $I_D = 35\text{ mA Typ.}$ OIP_3 Tone Spacing = 1 MHz, Pout per tone = -5 dBm
 $R_{BIAS} = 68\text{ Ohms}$ $T_L = 25^\circ\text{C}$ $Z_S = Z_L = 50\text{ Ohms}$

The information provided herein is believed to be reliable at press time. Stanford Microdevices assumes no responsibility for inaccuracies or omissions. Stanford Microdevices assumes no responsibility for the use of this information, and all such information shall be entirely at the user's own risk. Prices and specifications are subject to change without notice. No patent rights or licenses to any of the circuits described herein are implied or granted to any third party. Stanford Microdevices does not authorize or warrant any Stanford Microdevices product for use in life-support devices and/or systems. Copyright 2000 Stanford Microdevices, Inc. All worldwide rights reserved.

Typical RF Performance at Key Operating Frequencies

| Symbol | Parameter | Unit | Frequency (MHz) | | | | | |
|------------------|------------------------------------|------|-----------------|------|------|------|------|------|
| | | | 100 | 500 | 850 | 1950 | 2400 | 3500 |
| G | Small Signal Gain | dB | 14.8 | 14.6 | 14.4 | 13.6 | 13.3 | 12.5 |
| OIP ₃ | Output Third Order Intercept Point | dBm | | 26.1 | 26.2 | 24.1 | 22.6 | |
| P _{1dB} | Output Power at 1dB Compression | dBm | | 11.4 | 11.6 | 10.9 | 10.1 | |
| IRL | Input Return Loss | dB | 27.0 | 25.6 | 23.6 | 20.3 | 20.4 | 21.8 |
| ORL | Output Return Loss | dB | 20.8 | 22.9 | 28.0 | 21.5 | 19.4 | 22.7 |
| S ₁₂ | Reverse Isolation | dB | 18.2 | 18.4 | 18.6 | 19.1 | 19.1 | 18.9 |
| NF | Noise Figure | dB | | 3.7 | 3.6 | 3.8 | 4.3 | |

Test Conditions: V_S = 5 V, I_D = 20 mA Typ., OIP₃ Tone Spacing = 1 MHz, P_{out} per tone = -5 dBm
R_{BIAS} = 68 Ohms, T_L = 25°C, Z_S = Z_L = 50 Ohms

Noise Figure vs. Frequency

V_D = 2.6 V, I_D = 35 mA (Typ.)

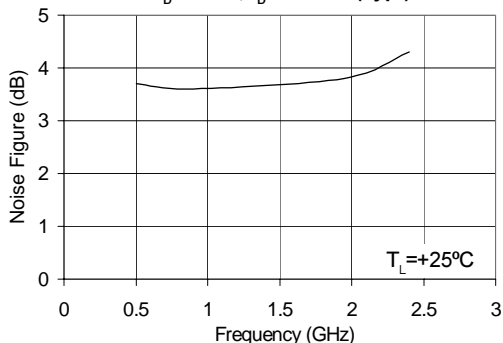

Absolute Maximum Ratings

| Parameter | Absolute Limit |
|---|----------------|
| Max. Device Current (I _D) | 70 mA |
| Max. Device Voltage (V _D) | 4 V |
| Max. RF Input Power | +5 dBm |
| Max. Junction Temp. (T _J) | +150°C |
| Operating Temp. Range (T _L) | -40°C to +85°C |
| Max. Storage Temp. | +150°C |

Operation of this device beyond any one of these limits may cause permanent damage.

Bias Conditions should also satisfy the following expression: I_D V_D (max) < (T_J - T_L)/R_{th}

OIP₃ vs. Frequency

V_D = 2.6 V, I_D = 35 mA (Typ.)

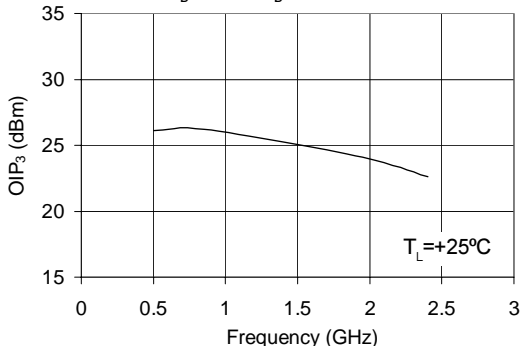

P_{1dB} vs. Frequency

V_D = 2.6 V, I_D = 35 mA (Typ.)

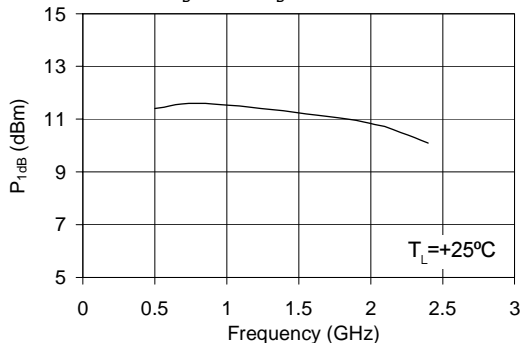

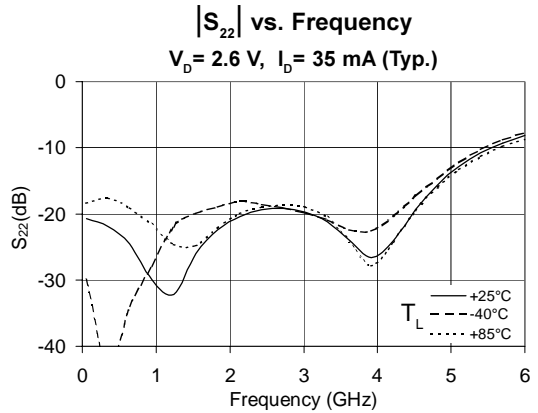
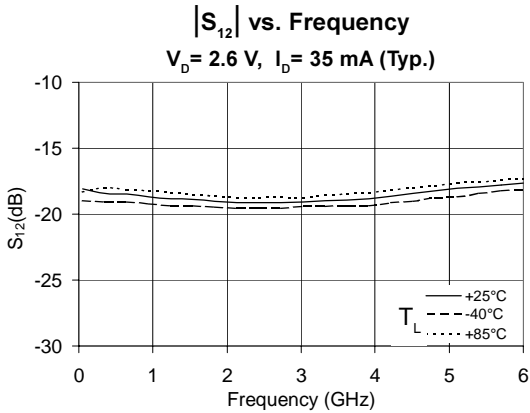
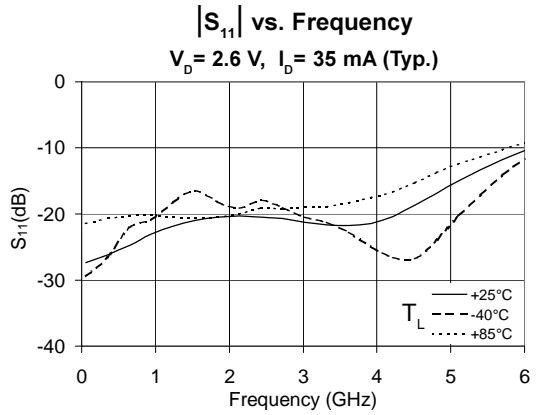
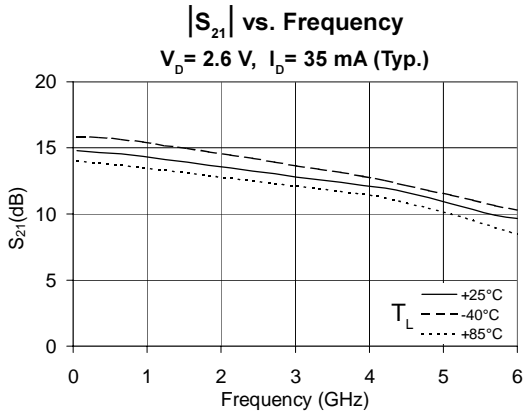

NOTE: Full S-parameter data available at www.stanfordmicro.com

Basic Application Circuit

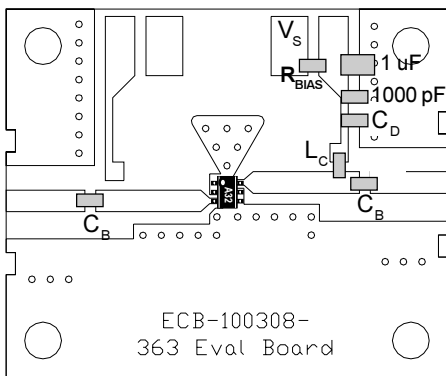
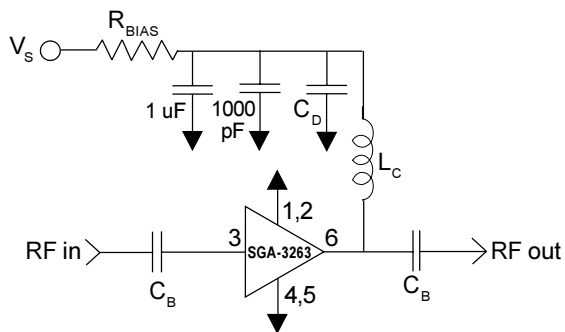

Part Identification Marking

The part will be marked with an "A32" designator on the top surface of the package.

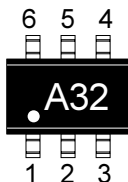

For package dimensions, refer to outline drawing at www.stanfordmicro.com



Caution: ESD sensitive

Appropriate precautions in handling, packaging and testing devices must be observed.

Application Circuit Element Values

| Reference Designator | Frequency (Mhz) | | | | |
|----------------------|-----------------|--------|-------|-------|-------|
| | 500 | 850 | 1950 | 2400 | 3500 |
| C _B | 220 pF | 100 pF | 68 pF | 56 pF | 39 pF |
| C _D | 100 pF | 68 pF | 22 pF | 22 pF | 15 pF |
| L _C | 68 nH | 33 nH | 22 nH | 18 nH | 15 nH |

Recommended Bias Resistor Values for I_D=35mA

| Supply Voltage(V _S) | 5 V | 8 V | 10 V | 12 V |
|---------------------------------|------|-------|-------|-------|
| R _{BIAS} | 68 Ω | 150 Ω | 200 Ω | 270 Ω |

Note: R_{BIAS} provides DC bias stability over temperature.

Mounting Instructions

- Use a large ground pad area near device pins 1, 2, 4, and 5 with many plated through-holes as shown.
-
- We recommend 1 or 2 ounce copper. Measurements for this data sheet were made on a 31 mil thick FR-4 board with 1 ounce copper on both sides.

| Pin # | Function | Description |
|-------|-------------|---|
| 3 | RF IN | RF input pin. This pin requires the use of an external DC blocking capacitor chosen for the frequency of operation. |
| 1 | GND | Connection to ground. Use via holes for best performance to reduce lead inductance as close to ground leads as possible. |
| 6 | RF OUT/BIAS | RF output and bias pin. DC voltage is present on this pin, therefore a DC blocking capacitor is necessary for proper operation. |
| 2,4,5 | GND | Sames as Pin 2 |

Part Number Ordering Information

| Part Number | Reel Size | Devices/Reel |
|-------------|-----------|--------------|
| SGA-3263 | 7" | 3000 |