

HIGH PERFORMANCE TRIAC

FEATURES

- HIGH COMMUTATION $(di/dt)_c > 13 \text{ A/ms}$ without snubber
- HIGH STATIC $dV/dt > 500 \text{ V}/\mu\text{s}$

DESCRIPTION

The T2535-600G triac uses a high performance SNUBBERLESSTM technology.

The part is intended for general purpose applications using surface mount technology.

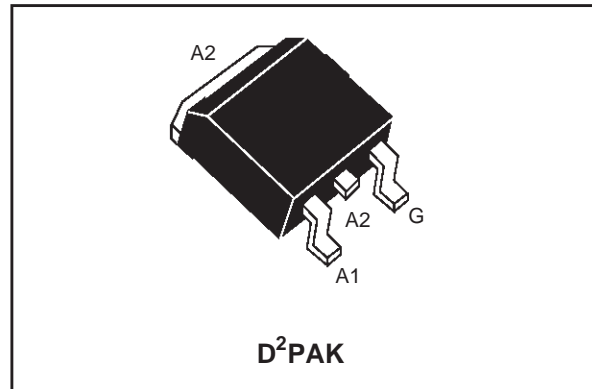

ABSOLUTE RATINGS (limiting values)

Symbol	Parameter	Value	Unit	
V_{DRM} V_{RRM}	Repetitive peak off-state voltage	$T_j = 125^\circ\text{C}$ 600	V	
$I_{T(RMS)}$	RMS on-state current (360° conduction angle)	$T_c = 95^\circ\text{C}$ 25	A	
I_{TSM}	Non repetitive surge peak on-state current (T_j initial = 25°C)	$t_p = 8.3\text{ms}$	262	A
		$t_p = 10 \text{ ms}$	250	
I^2t	I^2t Value (half-cycle, 50 Hz)	$t_p = 10 \text{ ms}$	312.5	A^2s
di/dt	Critical rate of rise of on-state current $I_G = 500 \text{ mA}$ $dI_G/dt = 1 \text{ A}/\mu\text{s}$.	Repetitive $F = 50 \text{ Hz}$	20	$\text{A}/\mu\text{s}$
		Non Repetitive	100	
T_{stg} T_j	Storage temperature range Operating junction temperature range	- 40, + 150 - 40, + 125	$^\circ\text{C}$	
TI	Maximum temperature for soldering during 10s	260	$^\circ\text{C}$	

T2535-600G

THERMAL RESISTANCES

Symbol	Parameter	Value	Unit
Rth(j-a)	Junction to ambient (S=1cm ²)	45	°C/W
Rth(j-c)	Junction to case for DC	1.4	°C/W
Rth(j-c)	Junction to case for AC 360° conduction angle (F=50Hz)	1.0	°C/W

GATE CHARACTERISTICS (maximum values)

$P_{G(AV)} = 1 \text{ W}$ $P_{GM} = 10 \text{ W}$ (tp = 20 μs) $I_{GM} = 4 \text{ A}$ (tp = 20 μs)

ELECTRICAL CHARACTERISTICS

Symbol	Test Conditions		Quadrant		Sensitivity	Unit
I _{GT}	V _D =12V (DC) R _L =33Ω	T _j = 25°C	I-II-III	MIN	2	mA
				MAX	35	
V _{GT}	V _D =12V (DC) R _L =33Ω	T _j = 25°C	I-II-III	MAX	1.3	V
V _{GD}	V _D =V _{DRM} R _L =3.3kΩ	T _j = 125°C	I-II-III	MIN	0.2	V
I _H *	I _T = 500mA Gate open	T _j = 25°C		MAX	50	mA
I _L	I _G = 1.2 I _{GT}	T _j = 25°C	I-II-III	MAX	80	mA
V _{TM} *	I _{TM} = 35A tp= 380μs	T _j = 25°C		MAX	1.5	V
I _{DRM}	V _D = V _{DRM}	T _j = 25°C		MAX	5	μA
I _{RRM}	V _R = V _R RM	T _j = 125°C		MAX	3	mA
dV/dt *	Linear slope up to V _D =67%V _{DRM} Gate open	T _j = 125°C		MIN	500	V/μs
(di/dt) _c *	Without snubber	T _j = 125°C		MIN	13	A/ms

* For either polarity of electrode A2 voltage with reference to electrode A1.

ORDERING INFORMATION Add "-TR" suffix for Tape & Reel shipment

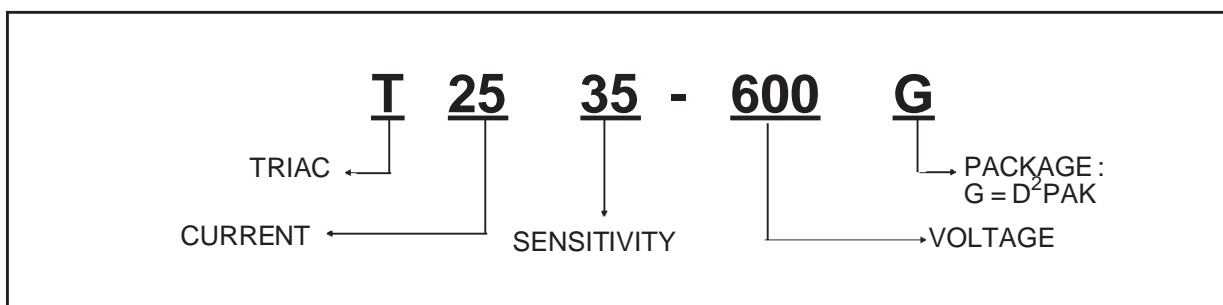

Fig. 1: Maximum power dissipation versus RMS on-state current .

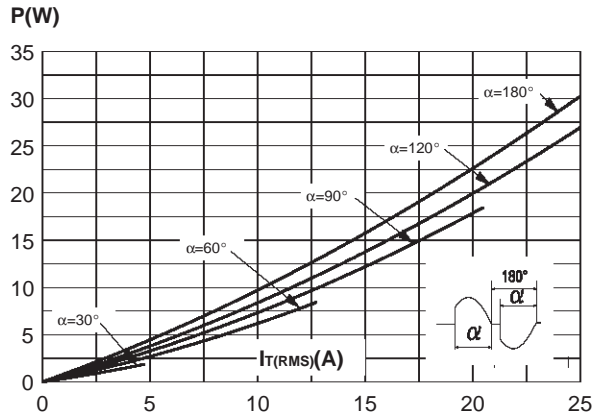

Fig. 2: Correlation between maximum power dissipation and maximum allowable temperatures (T_{amb} and T_{case}) for different thermal resistances heatsink+contact.

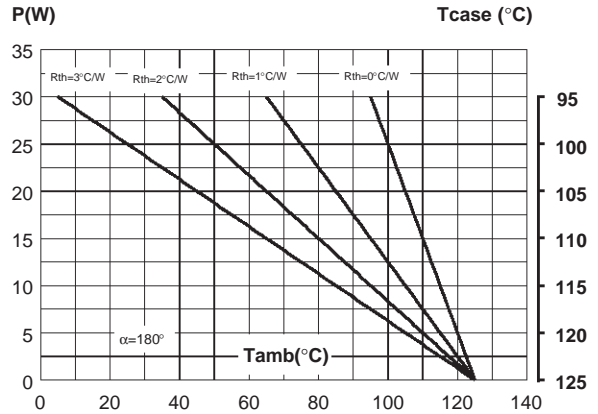

Fig. 3: RMS on-state current versus case temperature.

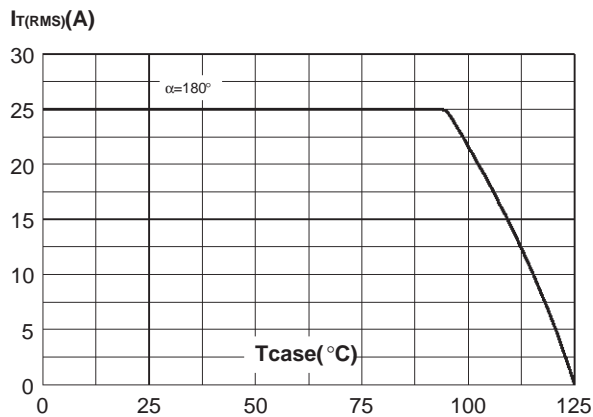

Fig. 4: Relative variation of thermal impedance versus pulse duration.

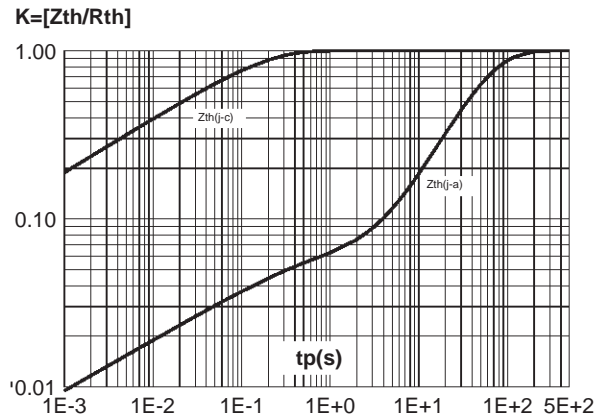

Fig. 5: Relative variation of gate trigger current and holding current versus junction temperature (typical values).

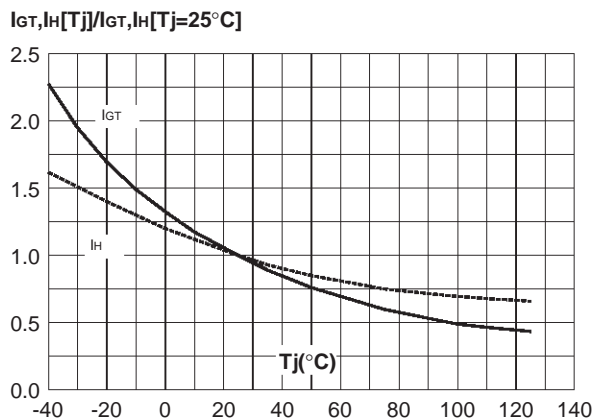

Fig. 6: Non repetitive surge peak on-state current versus number of cycles.

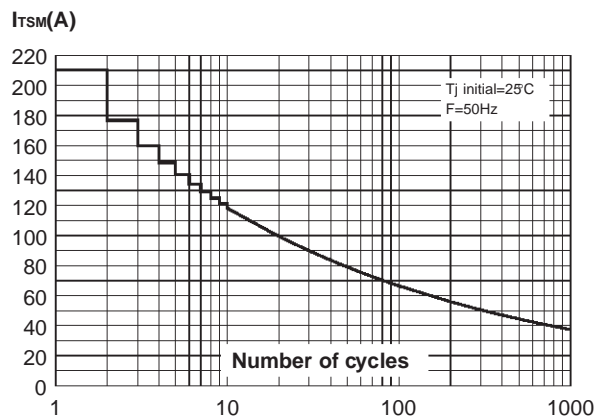

Fig. 7: Non repetitive surge peak on-state current for a sinusoidal pulse with width $t_p < 10\text{ms}$, and corresponding value of I^2t .

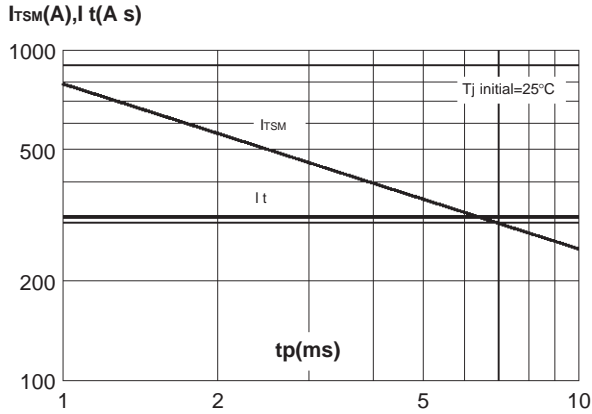

Fig. 9: Thermal resistance junction to ambient versus copper surface under tab (Epoxy printed circuit board FR4, copper thickness: $35\mu m$).

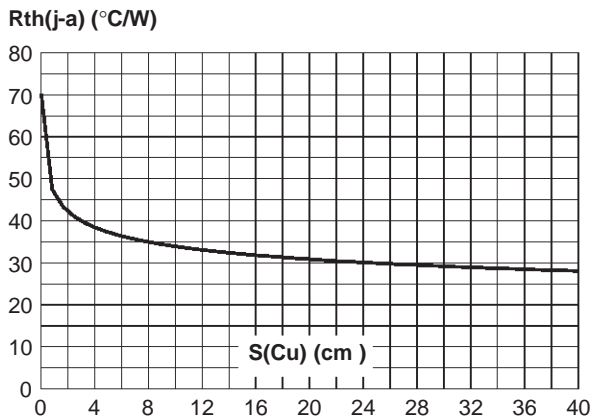

Fig. 8: On-state characteristics (maximum values).

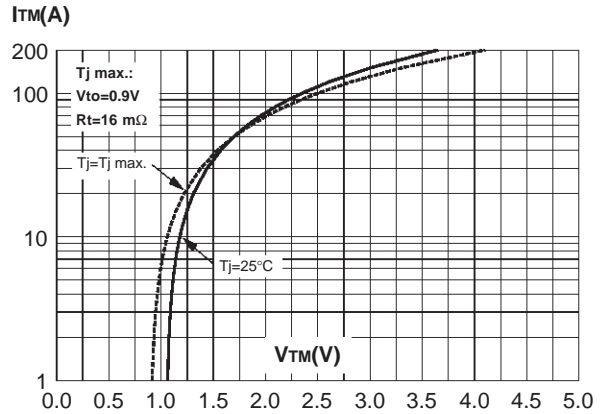
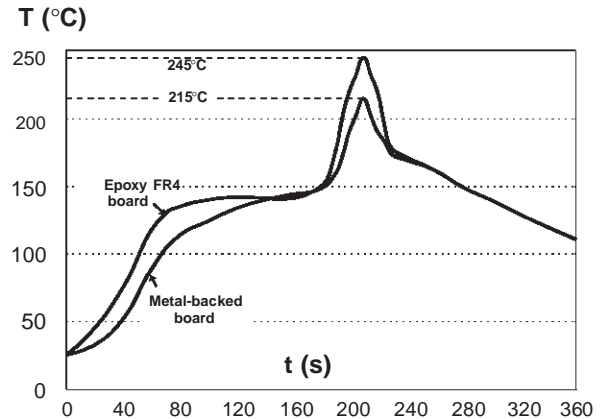
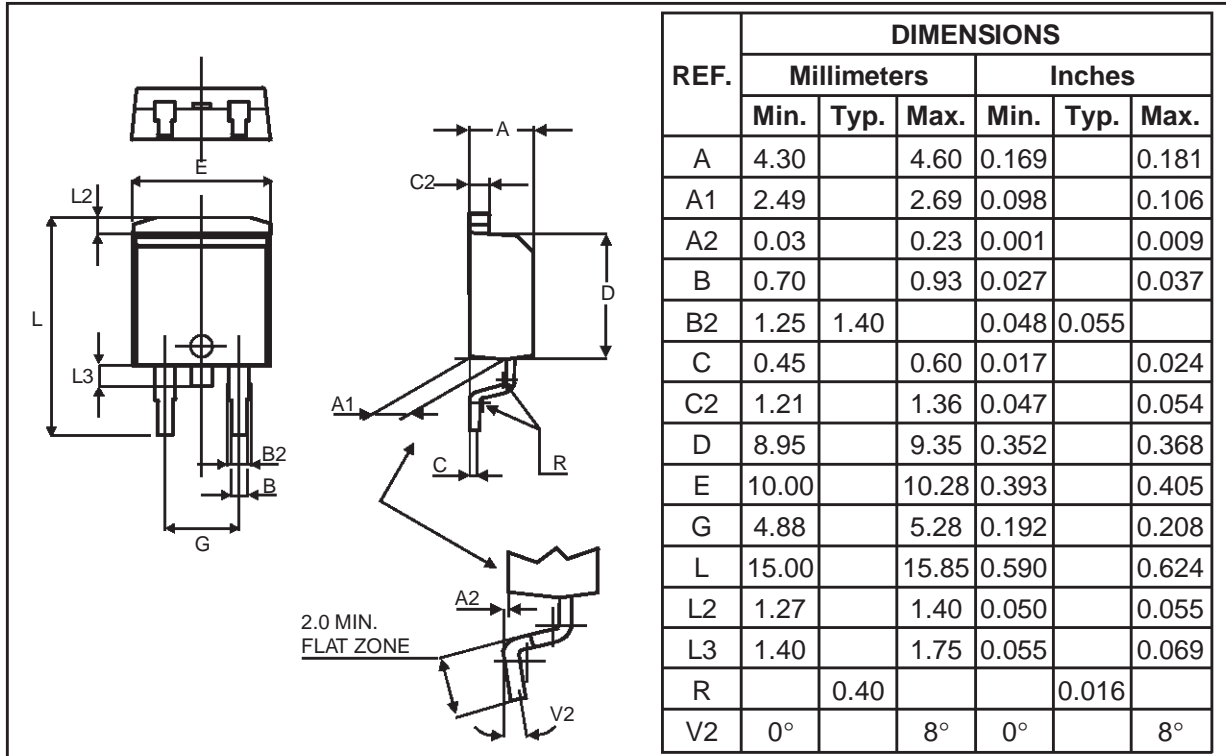

Fig. 10: Typical reflow soldering heat profile, either for mounting on FR4 or metal-backed boards.



PACKAGE MECHANICAL DATA
D²PAK



FOOT PRINT DIMENSIONS (in millimeters)

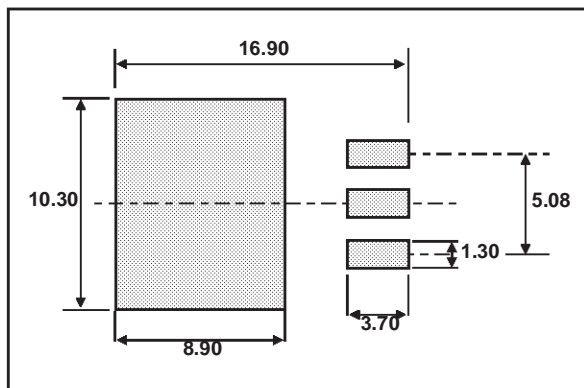

MARKING : T2535
600G

Information furnished is believed to be accurate and reliable. However, STMicroelectronics assumes no responsibility for the consequences of use of such information nor for any infringement of patents or other rights of third parties which may result from its use. No license is granted by implication or otherwise under any patent or patent rights of STMicroelectronics. Specifications mentioned in this publication are subject to change without notice. This publication supersedes and replaces all information previously supplied. STMicroelectronics products are not authorized for use as critical components in life support devices or systems without express written approval of STMicroelectronics.

© 1998 STMicroelectronics - Printed in Italy - All rights reserved.

STMicroelectronics GROUP OF COMPANIES

Australia - Brazil - Canada - China - France - Germany - Italy - Japan - Korea - Malaysia - Malta - Mexico - Morocco - The Netherlands - Singapore - Spain - Sweden - Switzerland - Taiwan - Thailand - United Kingdom - U.S.A.