



# PD54003 - PD54003S

## RF POWER TRANSISTORS

### The *LdmoST* Plastic FAMILY

PRELIMINARY DATA

#### N-CHANNEL ENHANCEMENT-MODE LATERAL MOSFETs

- EXCELLENT THERMAL STABILITY
- COMMON SOURCE CONFIGURATION
- POUT = 3 W with 12 dB gain @ 500 MHz / 7.5V
- NEW RF PLASTIC PACKAGE

#### DESCRIPTION

The PD5400 is a common source N-Channel, enhancement-mode, lateral Field-Effect RF power transistor. It is designed for high gain, broad band commercial and industrial applications. It operates at 7V in common source mode at frequencies of up to 1GHz. PD54003 boasts the excellent gain, linearity and reliability of ST's latest LDMOS technology mounted in the first true SMD plastic RF power package, PowerSO-10RF. PD54003's superior linearity performance makes it an ideal solution for portable radio.

The PowerSO-10 plastic package, designed to offer high reliability, is the first ST JEDEC approved, high power SMD package. It has been specially optimized for RF needs and offers excellent RF performances and ease of assembly.

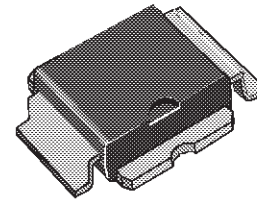

PowerSO-10RF  
(Formed Lead)

ORDER CODE	BRANDING
PD54003	XPD54003

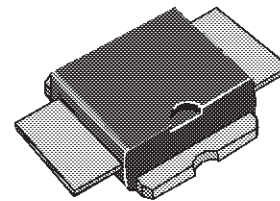

PowerSO-10RF  
(Straight Lead)

ORDER CODE	BRANDING
PD54003S	XPD54003S

#### ABSOLUTE MAXIMUM RATINGS ( $T_{CASE} = 25^{\circ}C$ )

Symbol	Parameter	Value	Unit
$V_{(BR)DSS}$	Drain Source Voltage	25	V
$V_{GS}$	Gate-Source Voltage	$\pm 20$	V
$I_D$	Drain Current	4	A
$P_{DISS}$	Power Dissipation (@ $T_c = 70^{\circ}C$ )	52.8	W
$T_j$	Max. Operating Junction Temperature	165	$^{\circ}C$
$T_{STG}$	Storage Temperature	-65 to 165	$^{\circ}C$

#### THERMAL DATA

$R_{th(j-c)}$	Junction-Case Thermal Resistance	1.8	$^{\circ}C/W$
---------------	----------------------------------	-----	---------------

**PD54003 - PD54003S**

**ELECTRICAL SPECIFICATION**( $T_{CASE} = 25\text{ }^{\circ}\text{C}$ )

**STATIC**

Symbol	Parameter			Min.	Typ.	Max.	Unit
$I_{DSS}$	$V_{GS} = 0\text{ V}$	$V_{DS} = 25\text{ V}$				1	$\mu\text{A}$
$I_{GSS}$	$V_{GS} = 20\text{ V}$	$V_{DS} = 0\text{ V}$				1	$\mu\text{A}$
$V_{GS(Q)}$	$V_{DS} = 10\text{ V}$	$I_D = 50\text{ mA}$		2.0		5.0	V
$V_{DS(ON)}$	$V_{GS} = 10\text{ V}$	$I_D = 1\text{ A}$				1.3	V
$g_{FS}$	$V_{DS} = 10\text{ V}$	$I_D = 1\text{ A}$			1.5		mho
$C_{ISS}$	$V_{GS} = 0\text{ V}$	$V_{DS} = 7.5\text{ V}$	$f = 1\text{ MHz}$		59		pF
$C_{OSS}$	$V_{GS} = 0\text{ V}$	$V_{DS} = 7.5\text{ V}$	$f = 1\text{ MHz}$		43		pF
$C_{RSS}$	$V_{GS} = 0\text{ V}$	$V_{DS} = 7.5\text{ V}$	$f = 1\text{ MHz}$		4.0		pF

**DYNAMIC**

Symbol	Parameter				Min.	Typ.	Max.	Unit
$P_{OUT}$	$f = 500\text{ MHz}$	$V_{DD} = 7.5\text{ V}$	$I_{DQ} = 50\text{ mA}$		3			W
$G_{PS}$	$f = 500\text{ MHz}$	$V_{DD} = 7.5\text{ V}$	$P_{OUT} = 3\text{ W}$	$I_{DQ} = 50\text{ mA}$		12		dB
$\eta_D$	$f = 500\text{ MHz}$	$V_{DD} = 7.5\text{ V}$	$P_{OUT} = 3\text{ W}$	$I_{DQ} = 50\text{ mA}$		55		%
LOAD Mismatch	$f = 500\text{ MHz}$ ALL PHASE ANGLES	$V_{DD} = 9.5\text{ V}$	$P_{OUT} = 3\text{ W}$	$I_{DQ} = 50\text{ mA}$	20:1			VSWR

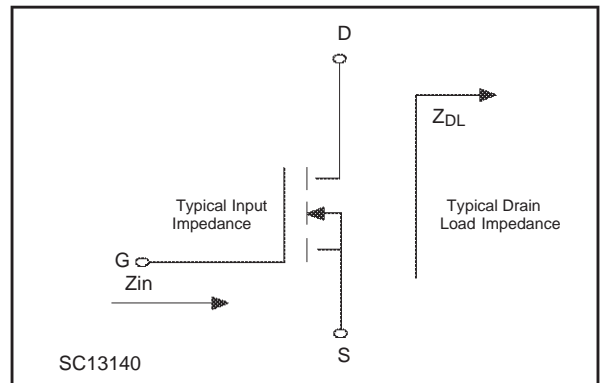
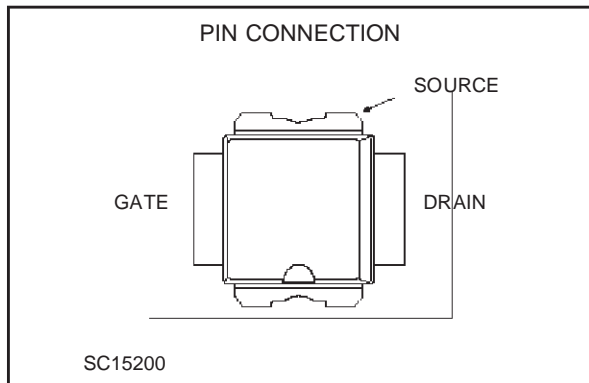

**IMPEDANCE DATA**

PD54003

Frequency MHz	$Z_{in}$ $\Omega$	$Z_{dl}$ $\Omega$
520	$1.993 - j1.098$	$2.564 + j0.656$
500	$1.553 - j1.251$	$2.661 + j0.139$
480	$2.245 - j0.077$	$3.436 + j1.013$

PD54003S

Frequency MHz	$Z_{in}$ $\Omega$	$Z_{dl}$ $\Omega$
520	$1.534 - j2.104$	$2.524 + j2.369$
500	$1.209 - j2.451$	$3.192 + j3.147$
480	$1.400 - j3.986$	$2.805 + j2.724$

TYPICAL PERFORMANCE

Capacitance vs. Drain Voltage

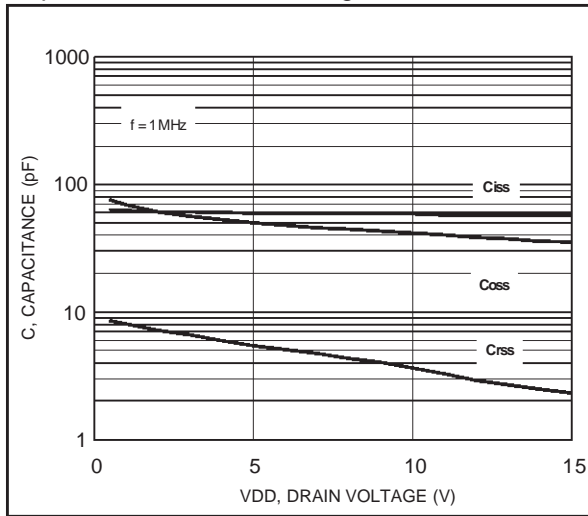

Drain Current vs. Gate Voltage

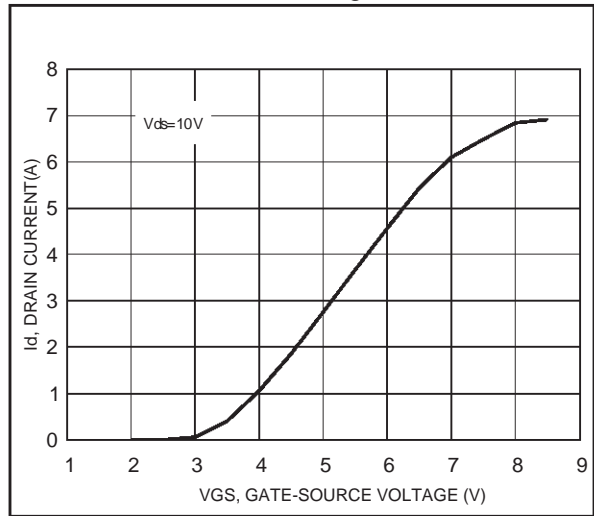

Gate-Source Voltage vs. Case Temperature

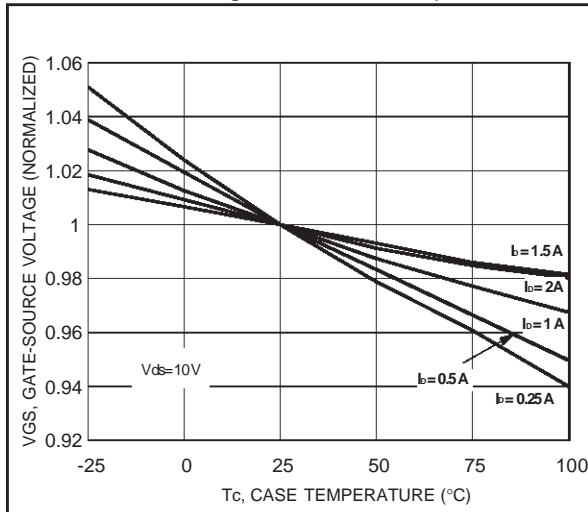

**PD54003 - PD54003S**

**TYPICAL PERFORMANCE**

Output Power vs. Input Power

**PD54003**

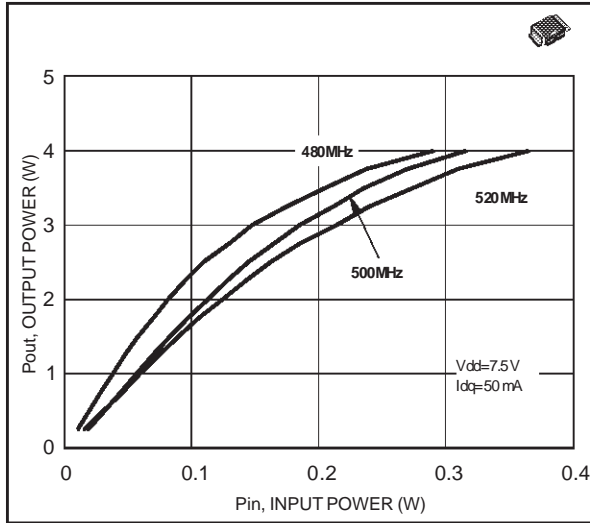

Power Gain vs. Output Power

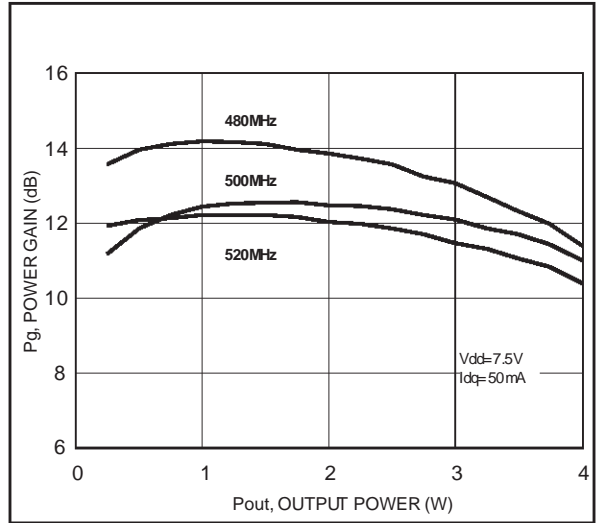

Drain Efficiency vs. Output Power

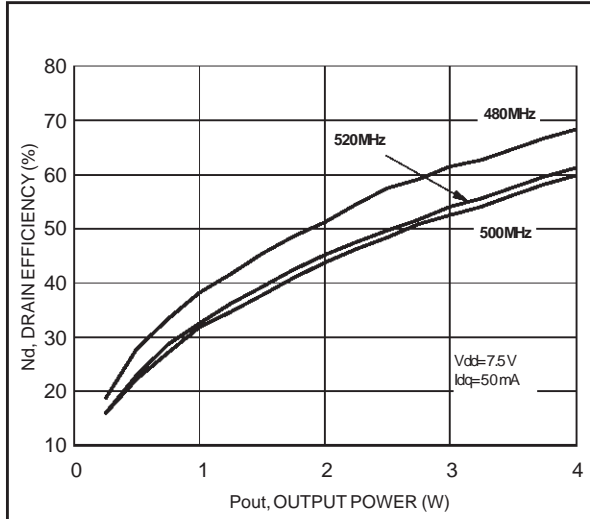

Return Loss vs. Output Power

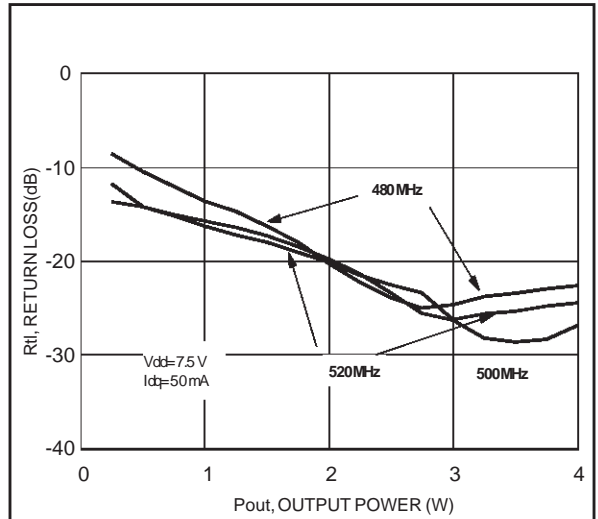

Output Power vs. Bias Current

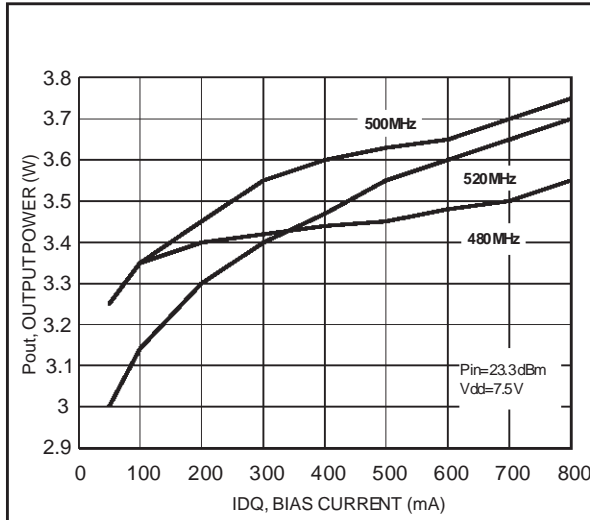

Drain Efficiency vs. Bias Current

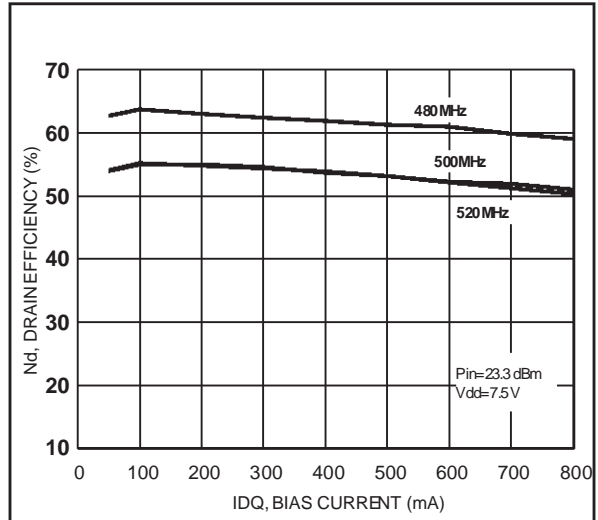

TYPICAL PERFORMANCE

Output Power vs. Supply Voltage

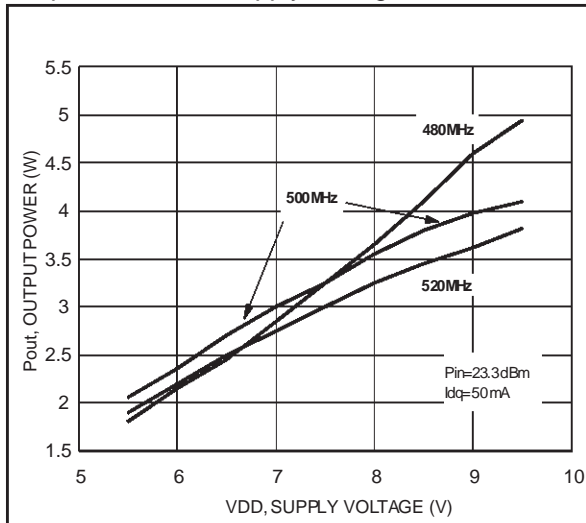

Drain Efficiency vs. Supply Voltage

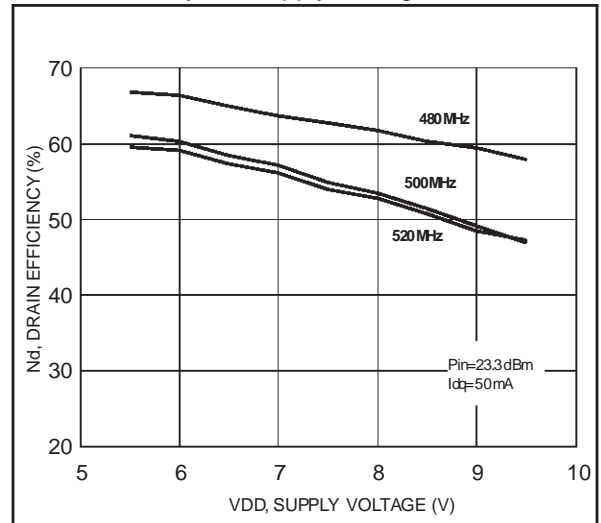

Output Power vs. Gate-Source Voltage

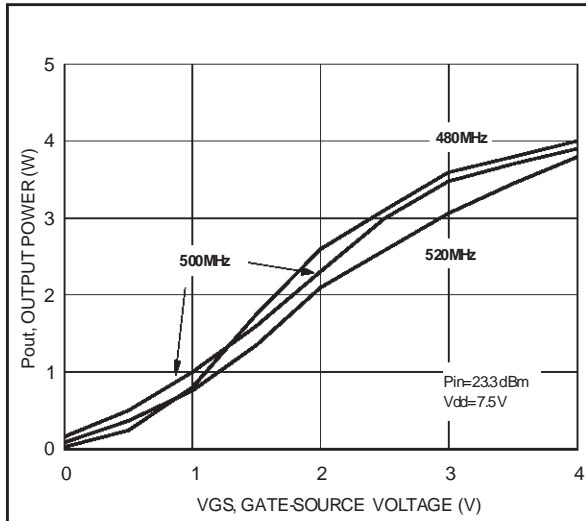

Output Power vs. Input Power **PD54003S**

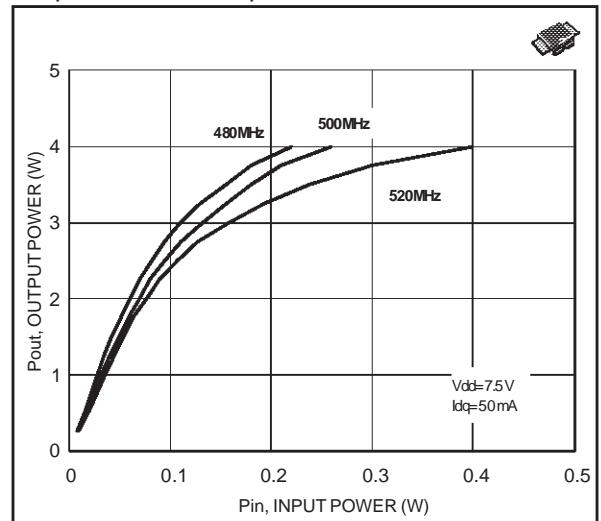

Power Gain vs. Output Power

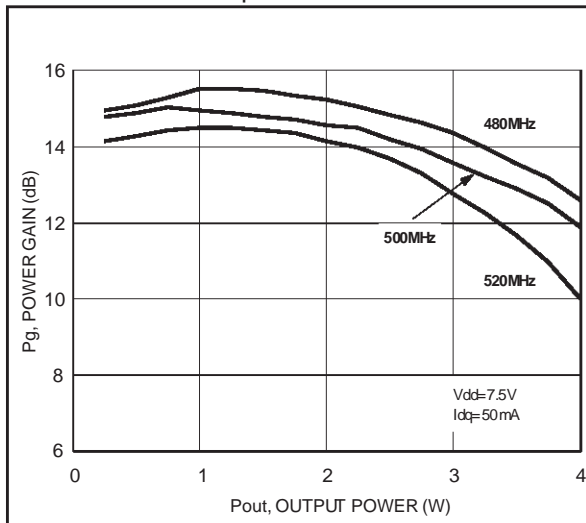

Drain Efficiency vs. Output Power

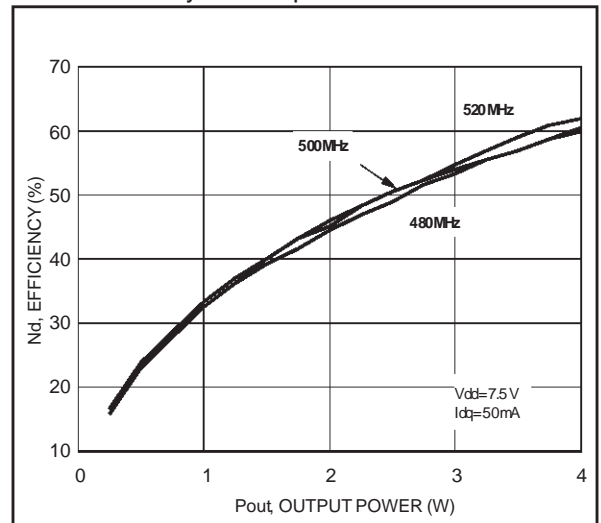

**PD54003 - PD54003S**

**TYPICAL PERFORMANCE**

Return Loss vs. Output Power

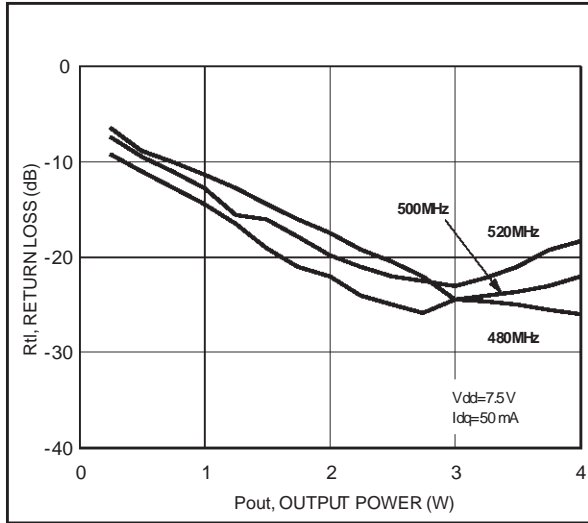

Output Power vs. Bias Current

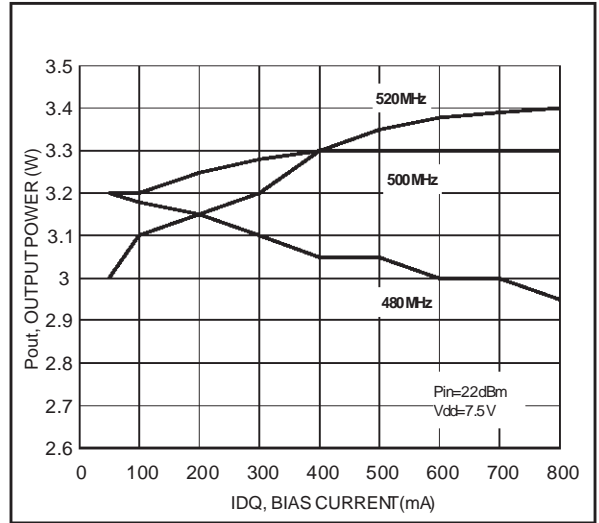

Drain Efficiency vs. Bias Current

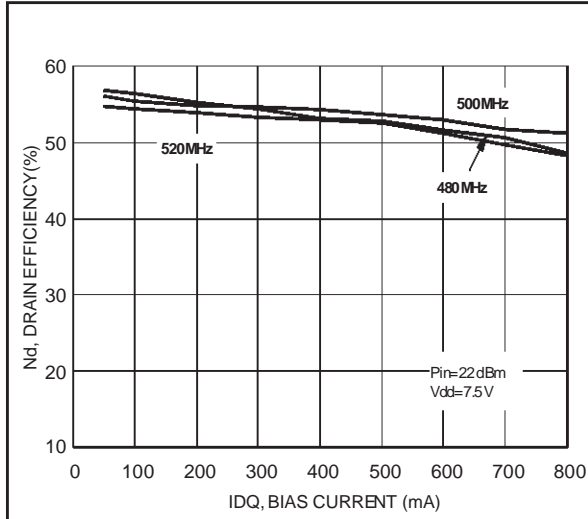

Output Power vs. Supply Voltage

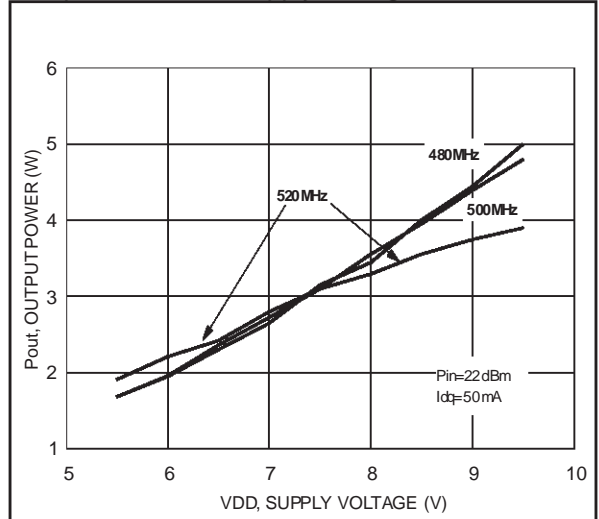

Drain Efficiency vs. Supply Voltage

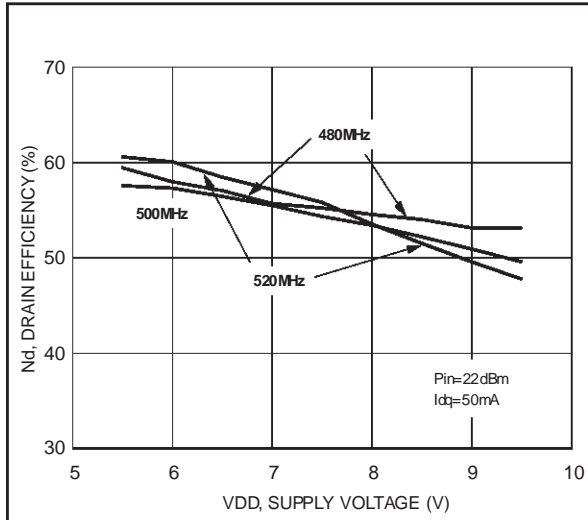

Output Power vs. Gate-Source Voltage

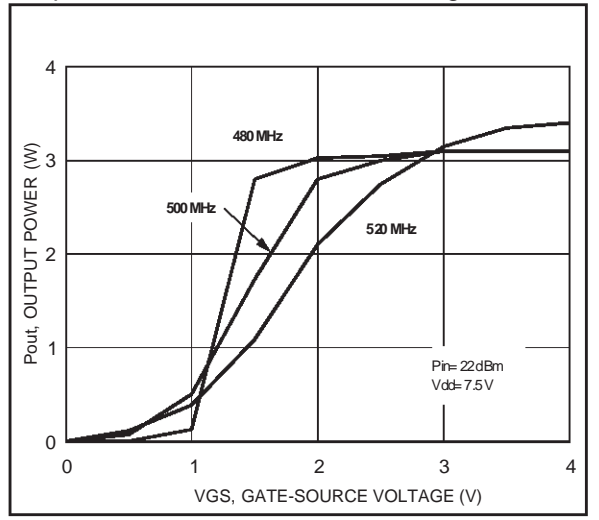

TEST CIRCUIT SCHEMATIC

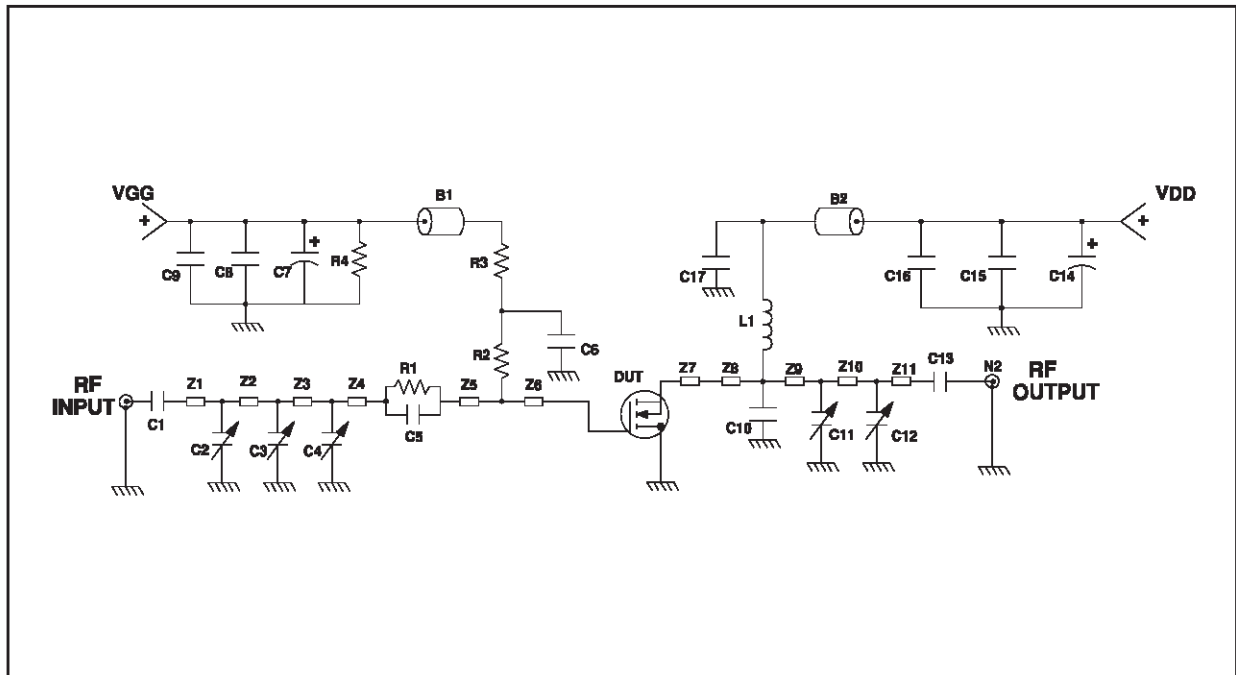

TEST CIRCUIT COMPONENT PART LIST

B1,B2	SHORT FERRITE BEAD, FAIR RITE PRODUCTS (2743021446)	R3	15 Ω, 0805 CHIP RESISTOR
C1,C13	240pF, 100 mil CHIP CAPACITOR	R4	33 KΩ, 1/8 W RESISTOR
C2,C3,C4,C10, C11,C12	0 TO 20pF TRIMMER CAPACITOR	Z1	0.175" X 0.080" MICROSTRIP
C5	130pF, 100 mil CHIP CAP	Z2	1.049" X 0.080" MICROSTRIP
C6,C17	120pF, 100 mil CHIP CAP	Z3	0.289" X 0.080" MICROSTRIP
C7,C14	10μF, 50V ELECTROLYTIC CAPACITOR	Z4	0.026" X 0.080" MICROSTRIP
C8,C15	1,200pF, 100 mil CHIP CAPACITOR	Z5	0.192" X 0.223" MICROSTRIP
C9,C16	0.1 F, 100 mil CHIP CAPACITOR	Z6,Z7	0.260" X 0.223" MICROSTRIP
L1	55.5 Nh, 5 TURN, COILCRAFT	Z8	0.064" X 0.080" MICROSTRIP
N1,N2	TYPE N FLANGE MOUNT	Z9	0.334" X 0.080" MICROSTRIP
R1	15 Ω, 0805 CHIP RESISTOR	Z10	0.985" X 0.080" MICROSTRIP
R2	1,0 KΩ, 1/8 W RESISTOR	Z11	0.472" X 0.080" MICROSTRIP
		BOARD	ROGER, ULTRA LAM 2000 THK 0.030", $\epsilon_r = 2.55$ 2oz. ED Cu 2 SIDES.

PD54003 - PD54003S

TEST CIRCUIT

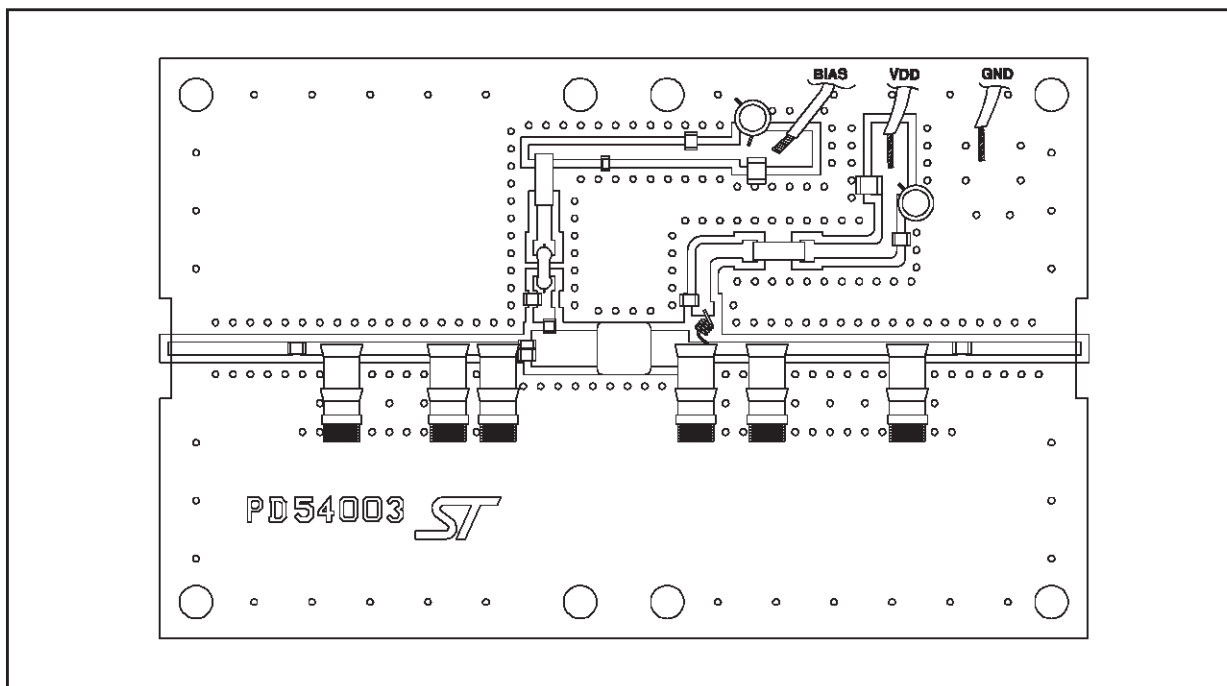

TEST CIRCUIT PHOTOMASTER

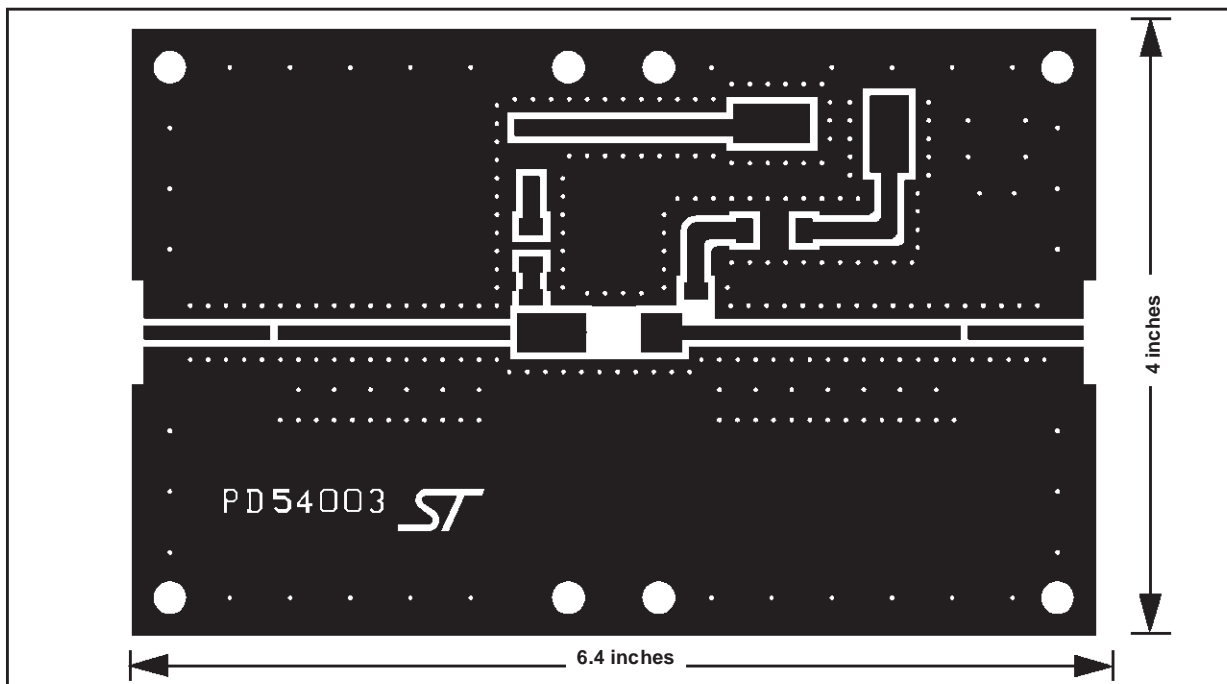



PowerSO-10RF (Straight Lead) MECHANICAL DATA

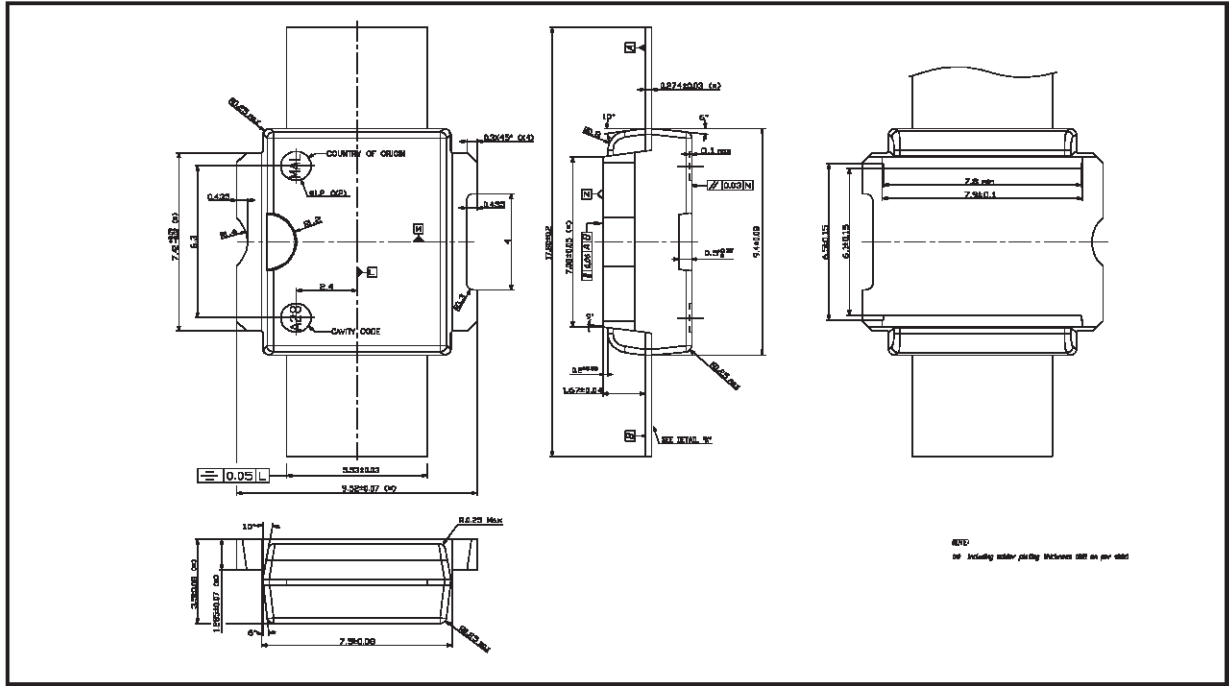

PowerSO-10RF (Formed Lead) MECHANICAL DATA

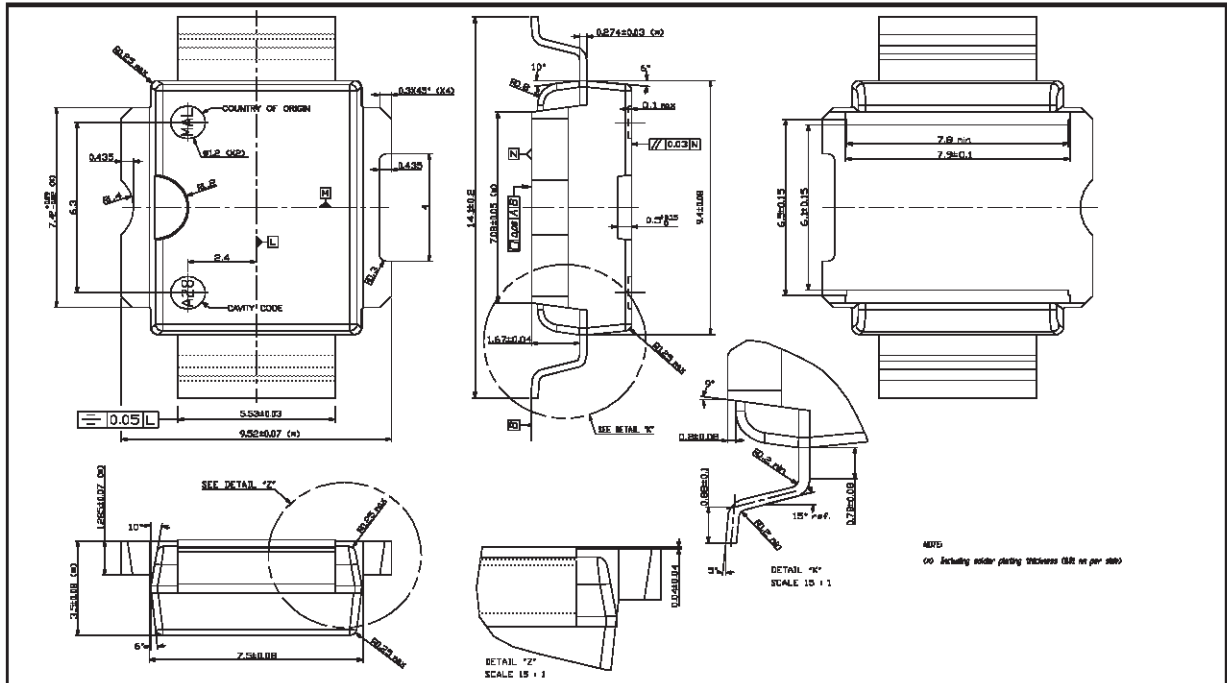

Information furnished is believed to be accurate and reliable. However, STMicroelectronics assumes no responsibility for the consequences of use of such information nor for any infringement of patents or other rights of third parties which may result from its use. No license is granted by implication or otherwise under any patent or patent rights of STMicroelectronics. Specifications mentioned in this publication are subject to change without notice. This publication supersedes and replaces all information previously supplied. STMicroelectronics products are not authorized for use as critical components in life support devices or systems without express written approval of STMicroelectronics.

The ST logo is registered trademark of STMicroelectronics  
® 2000 STMicroelectronics - All Rights Reserved

All other names are the property of their respective owners.

STMicroelectronics GROUP OF COMPANIES  
Australia - Brazil - China - Finland - France - Germany - Hong Kong - India - Italy - Japan - Malaysia - Malta - Morocco -  
Singapore - Spain - Sweden - Switzerland - United Kingdom - U.S.A.

<http://www.st.com>