



STPR1020CB/CG/CT/CF/CFP

ULTRA-FAST RECOVERY RECTIFIER DIODES

MAIN PRODUCTS CHARACTERISTICS

$I_{F(AV)}$	2 x 5 A
V_{RRM}	200 V
T_j (max)	150°C
V_F (max)	0.99 V
t_{rr} (max)	30 ns

PRELIMINARY DATASHEET

FEATURES

- SUITED FOR SMPS
- LOW LOSSES
- LOW FORWARD AND REVERSE RECOVERY TIME
- HIGH SURGE CURRENT CAPABILITY
- INSULATED PACKAGES: ISOWATT220AB / TO-220FP
Insulation Voltage = 2000V DC
Capacitance = 12 pF

DESCRIPTION

Dual center tap rectifier suited for Switched Mode Power Supplies and high frequency DC to DC converters.

Packaged in DPAK, D²PAK, TO-220AB, TO-220FP or ISOWATT220AB, this device is intended for use in low voltage, high frequency inverters, free wheeling and polarity protection applications.

ABSOLUTE MAXIMUM (limiting values, per diode)

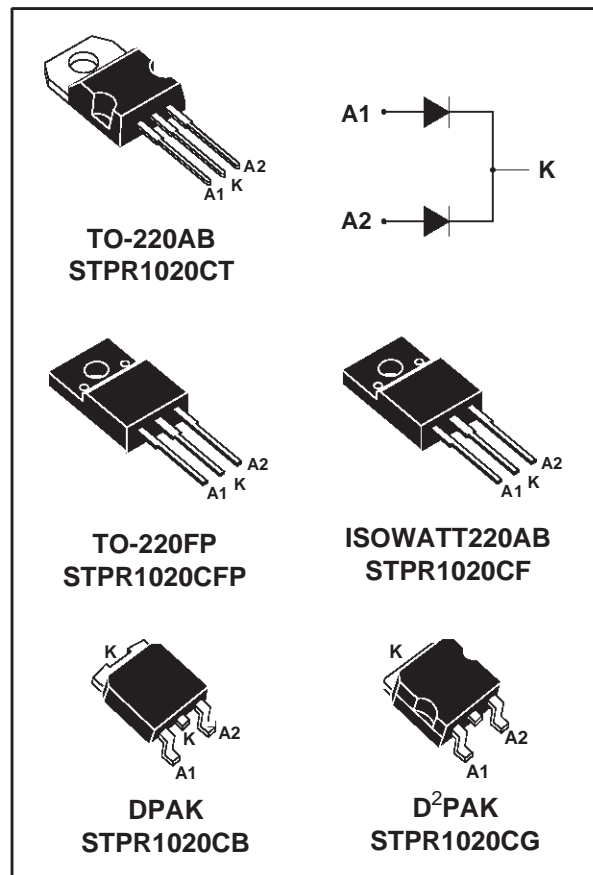

Symbol	Parameter			Value	Unit	
V_{RRM}	Repetitive peak reverse voltage			200	V	
$I_{F(RMS)}$	RMS forward current	D ² PAK / TO-220AB / ISOWATT220AB / TO-220FP		10	A	
		DPAK		7	A	
$I_{F(AV)}$	Average forward current $\delta = 0.5$	D ² PAK / DPAK	$T_c = 125^\circ\text{C}$	Per diode	5	A
		ISOWATT220AB	$T_c = 115^\circ\text{C}$	Per device	10	
		TO-220FP	$T_c = 110^\circ\text{C}$	Per device	10	
I_{FSM}	Surge non repetitive forward current		$t_p = 10\text{ms}$ sinusoidal	50	A	
T_{stg}	Storage temperature range			- 65 to + 150	°C	

STPR1020CB/CG/CT/CF/CFP

THERMAL RESISTANCES

Symbol	Parameter		Value	Unit	
R _{th(j-c)}	Junction to case	TO-220AB / D ² PAK / DPAK	Per diode	4.0	°C/W
			Total	2.4	
		ISOWATT220AB	Per diode	6.0	
			Total	4.0	
		TO-220FP	Per diode	6.5	
			Total	5	
R _{th(c)}	Coupling	TO-220AB / D ² PAK / DPAK	0.7		
		ISOWATT220AB	2.0		
		TO-220FP	3.5		

When diodes 1 and 2 are used simultaneously :

$$\Delta T_j(\text{diode } 1) = P(\text{diode } 1) \times R_{th(j-c)} (\text{Per diode}) + P(\text{diode } 2) \times R_{th(c)}$$

STATIC ELECTRICAL CHARACTERISTICS (per diode)

Symbol	Parameters	Test conditions		Min.	Typ.	Max.	Unit
I _R *	Reverse leakage current	T _j = 25°C	V _R = V _{RRM}			50	μA
		T _j = 100°C				0.6	mA
V _F **	Forward voltage drop	T _j = 125°C	I _F = 5 A		0.8	0.99	V
		T _j = 125°C	I _F = 10 A		0.95	1.20	
		T _j = 25°C	I _F = 10 A			1.25	

Pulse test : * tp = 5 ms, δ < 2 %

** tp = 380 μs, δ < 2 %

To evaluate the conduction losses use the following equation :

$$P = 0.78 \times I_{F(AV)} + 0.042 \times I_{F(RMS)}^2$$

RECOVERY CHARACTERISTICS

Symbol	Test conditions		Min.	Typ.	Max.	Unit
trr	T _j = 25°C	I _F = 0.5A I _R = 1A	I _{rr} = 0.25A		30	ns
tfr	T _j = 25°C	I _F = 1A V _{FR} = 1.1 x V _F max	dI _F /dt = 50 A/μs	20		ns
V _{FP}	T _j = 25°C	I _F = 1A	dI _F /dt = 50 A/μs	3		V

Fig. 1: Average forward power dissipation versus average forward current (per diode).

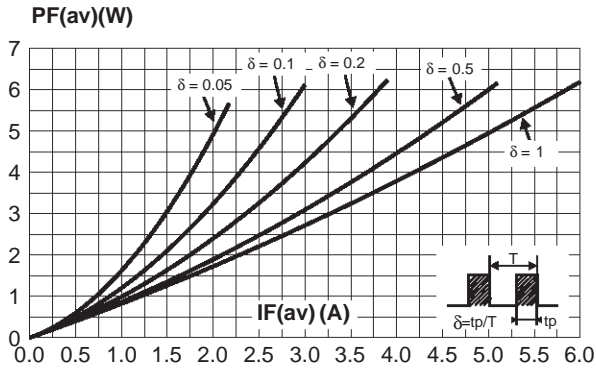

Fig. 2: Peak current versus form factor (per diode).

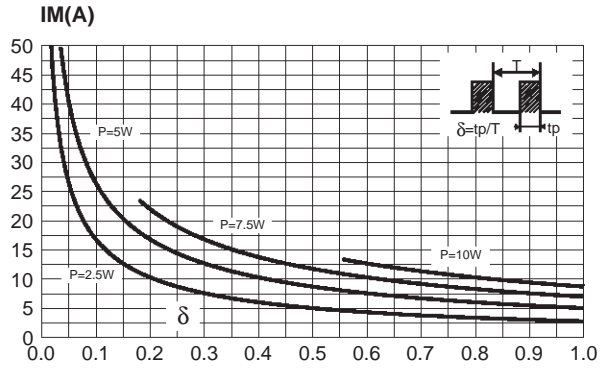

Fig. 3-1: Average forward current versus ambient temperature ($\delta = 0.5$, TO-220AB, DPAK, D²PAK).

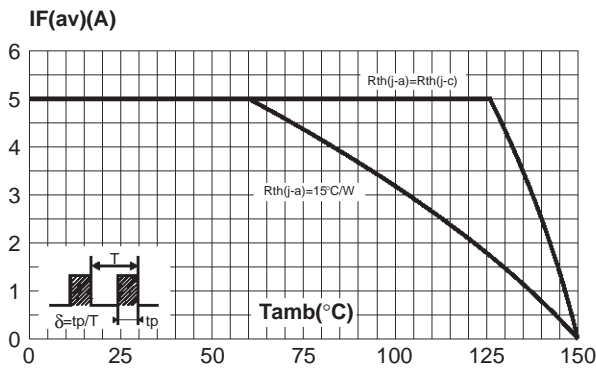

Fig. 3-2: Average forward current versus ambient temperature ($\delta = 0.5$, ISOWATT220AB, TO-220FP).

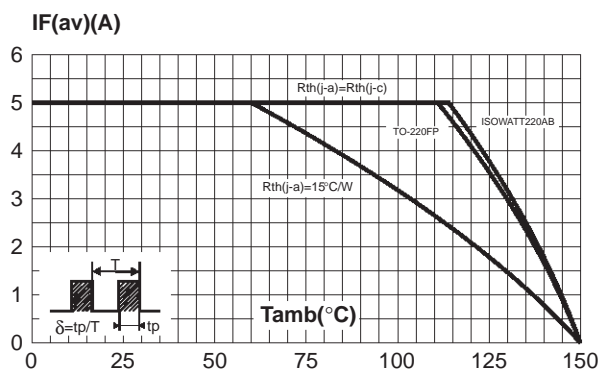

Fig. 4-1: Non repetitive surge peak forward current versus overload duration (TO-220AB, DPAK, D²PAK).

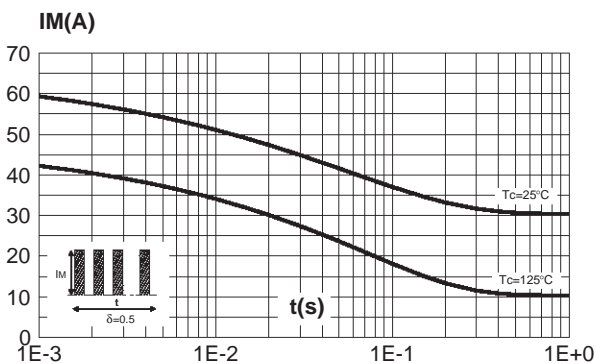

Fig. 4-2: Non repetitive surge peak forward current versus overload duration (ISOWATT220AB).

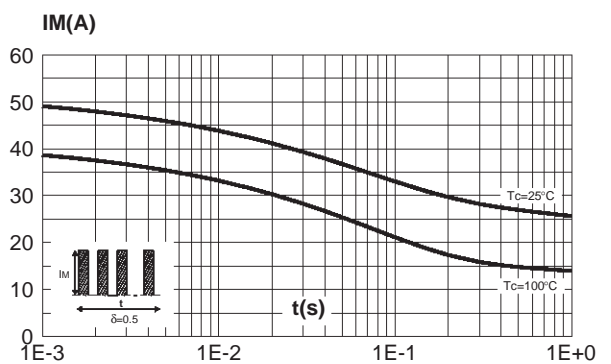

Fig. 4-3: Non repetitive surge peak forward current versus overload duration (TO-220FP).

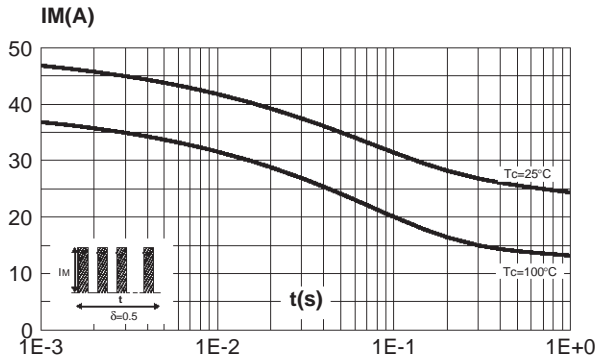

Fig. 5-1: Relative variation of thermal impedance junction to case versus pulse duration (D²PAK, DPAK, TO-220AB).

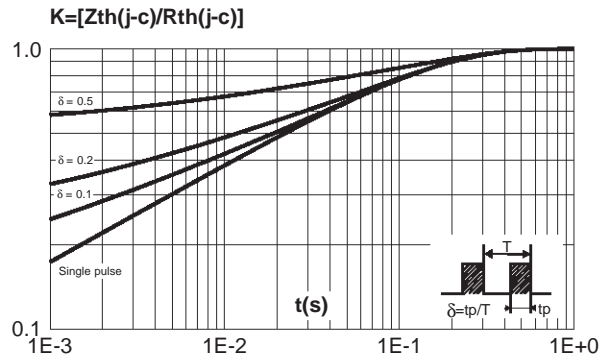

Fig. 5-2: Relative variation of thermal impedance junction to case versus pulse duration (ISOWATT220AB, TO-220FP).

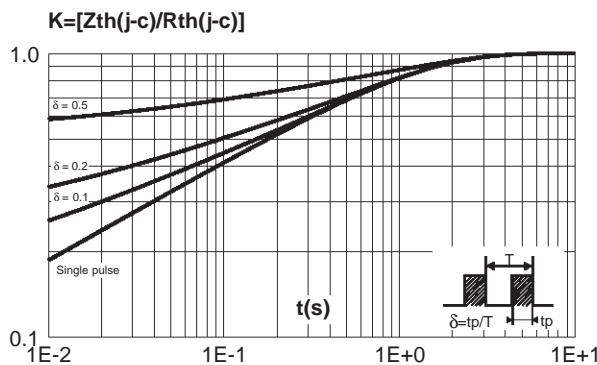

Fig. 6: Forward voltage drop versus forward current (maximum values, per diode).

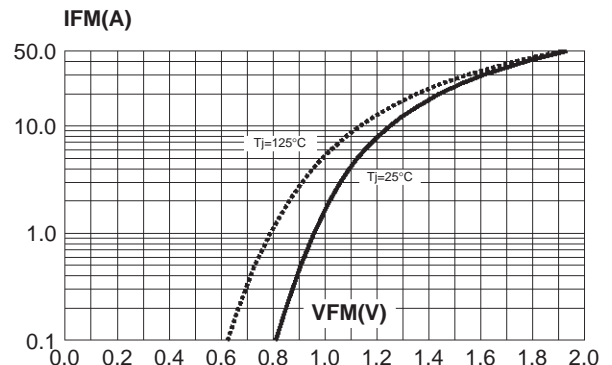

Fig. 7: Junction capacitance versus reverse voltage applied (typical values, per diode).

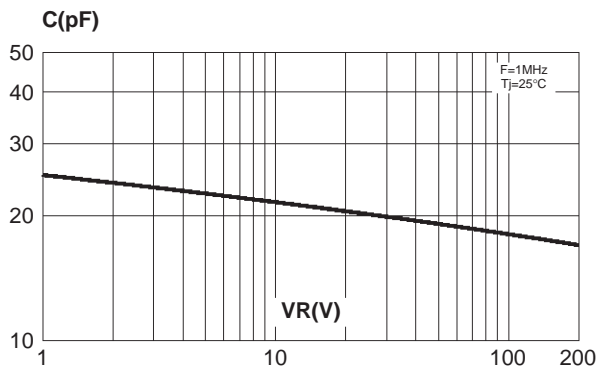

Fig. 8: Reverse recovery charges versus dIF/dt (per diode).

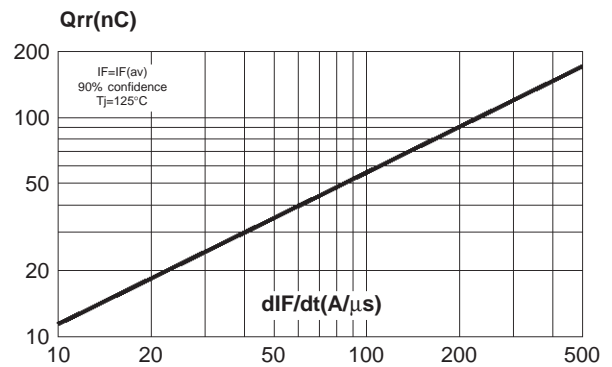

Fig. 9: Peak reverse recovery current versus dIF/dt (per diode).

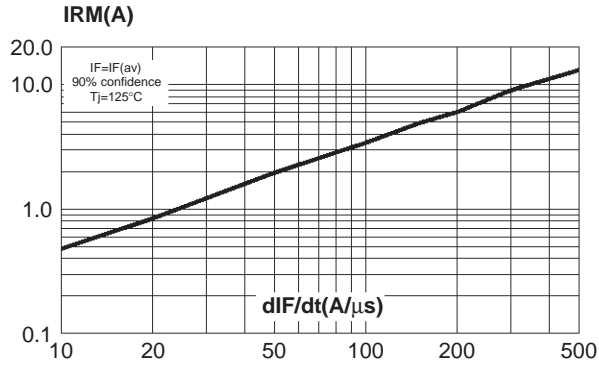

Fig. 10: Dynamic parameters versus junction temperature (per diode).

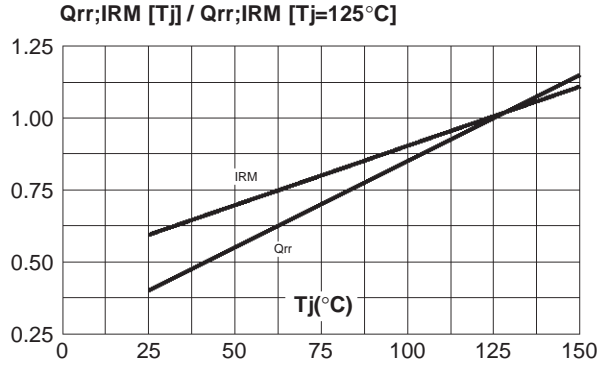
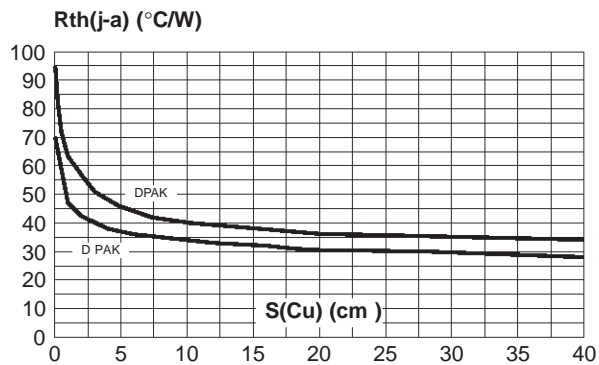
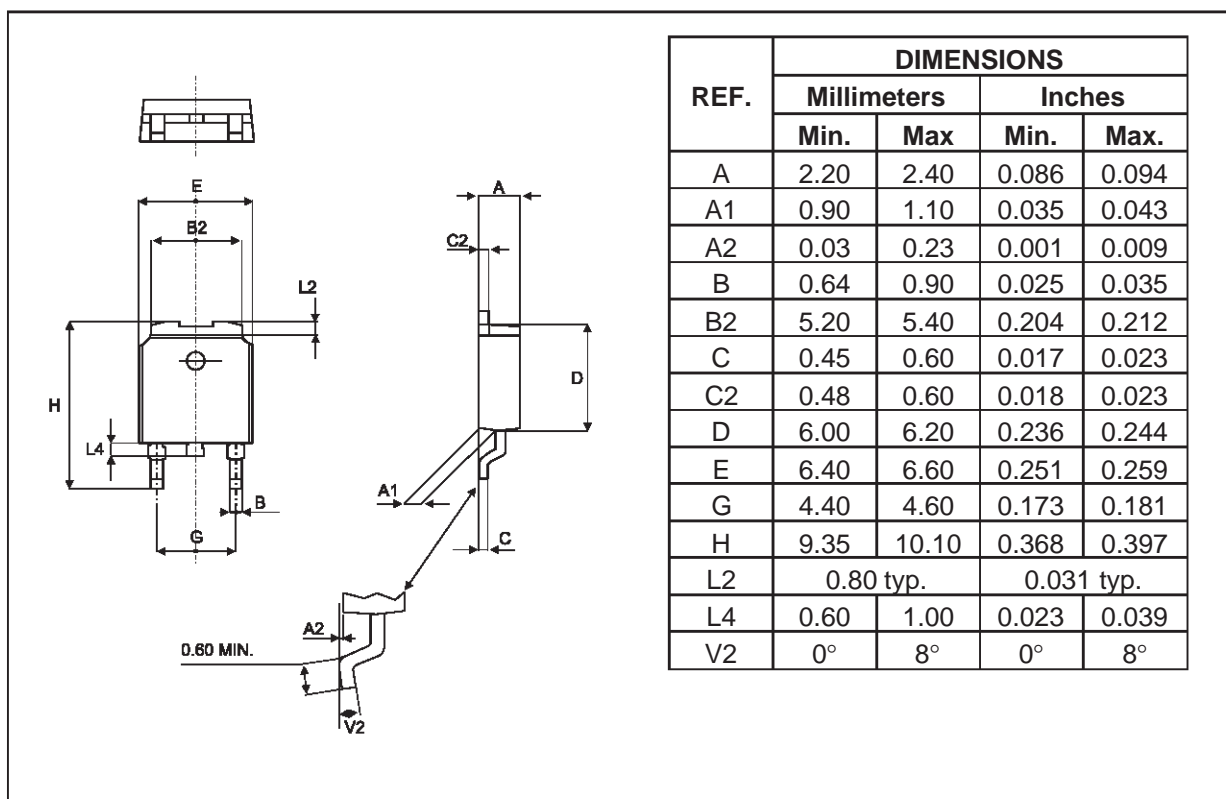

Fig. 11: Thermal resistance junction to ambient versus copper surface under tab (Epoxy printed circuit board FR4, copper thickness: 35 μ m).



STPR1020CB/CG/CT/CF/CFP

PACKAGE MECHANICAL DATA DPAK



FOOT PRINT (in millimeters) DPAK

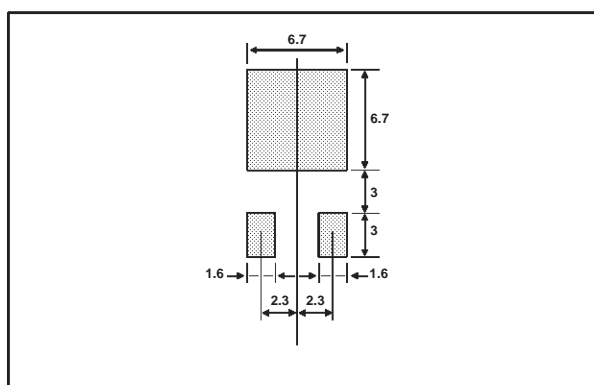

PACKAGE MECHANICAL DATA
D²PAK

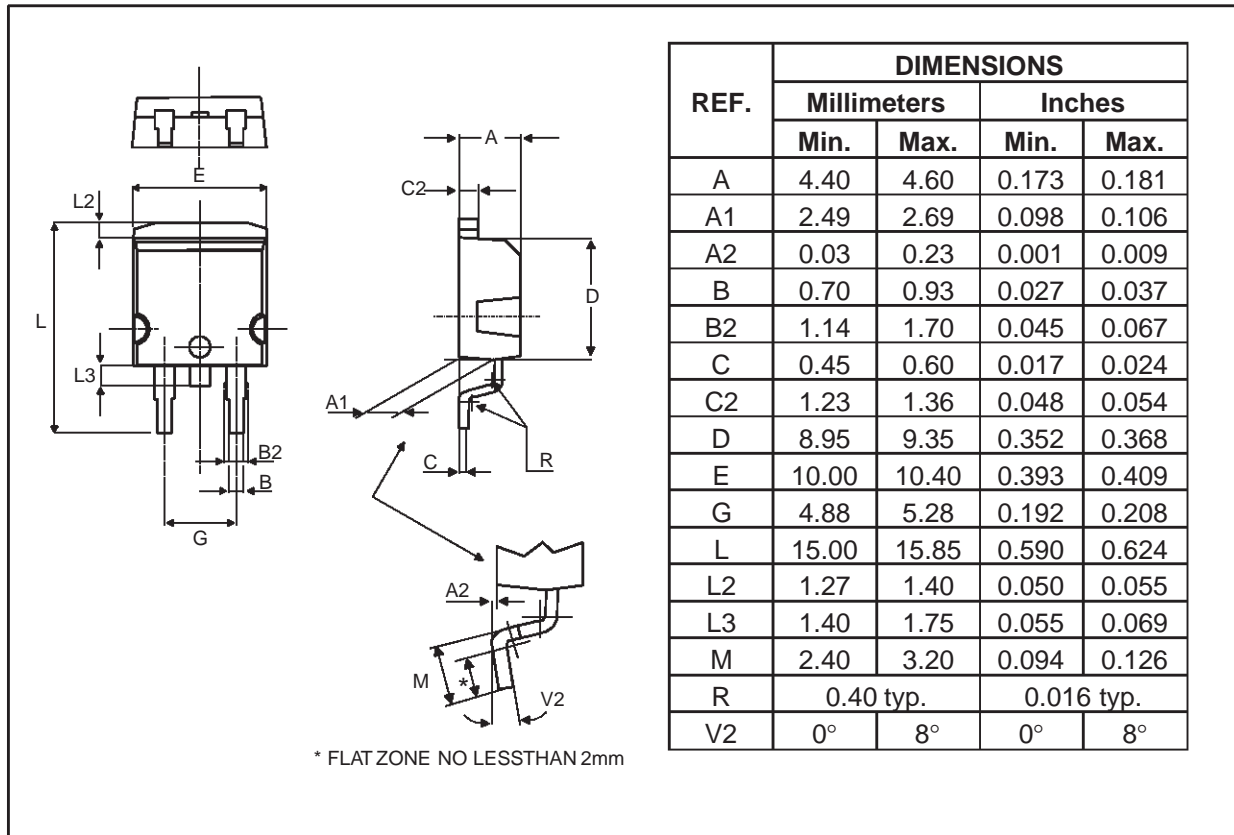

FOOT PRINT (in milliteters)
D²PAK

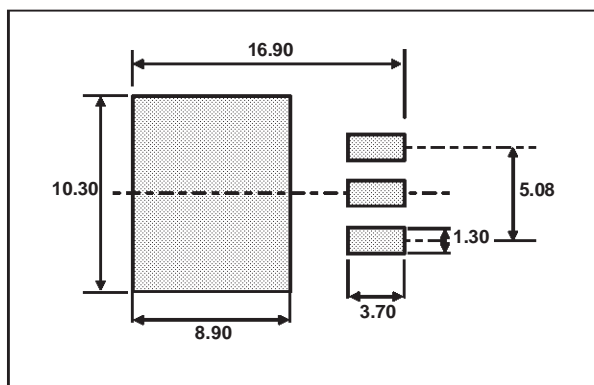

STPR1020CB/CG/CT/CF/CFP

PACKAGE MECHANICAL DATA TO-220AB (JEDEC compatible)

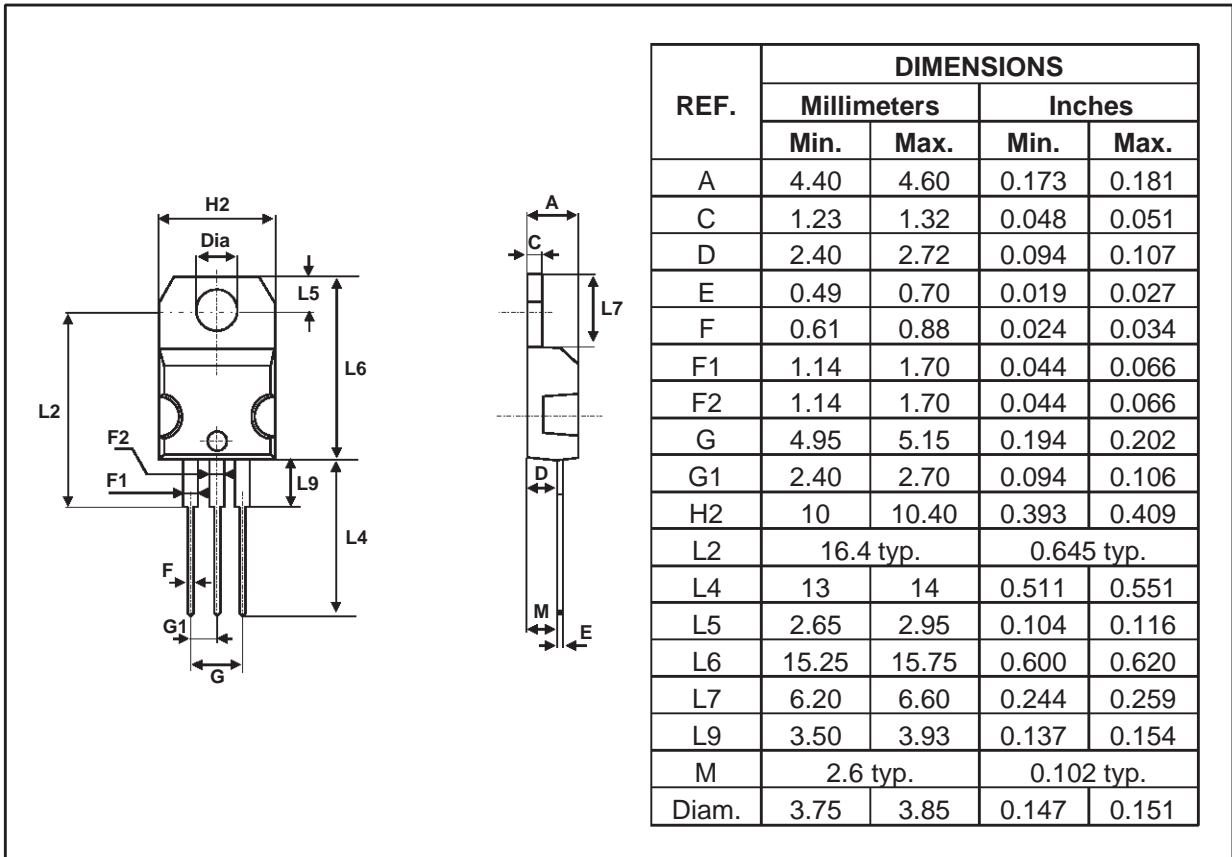

STPR1020CB/CG/CT/CF/CFP

PACKAGE MECHANICAL DATA

TO-220FP

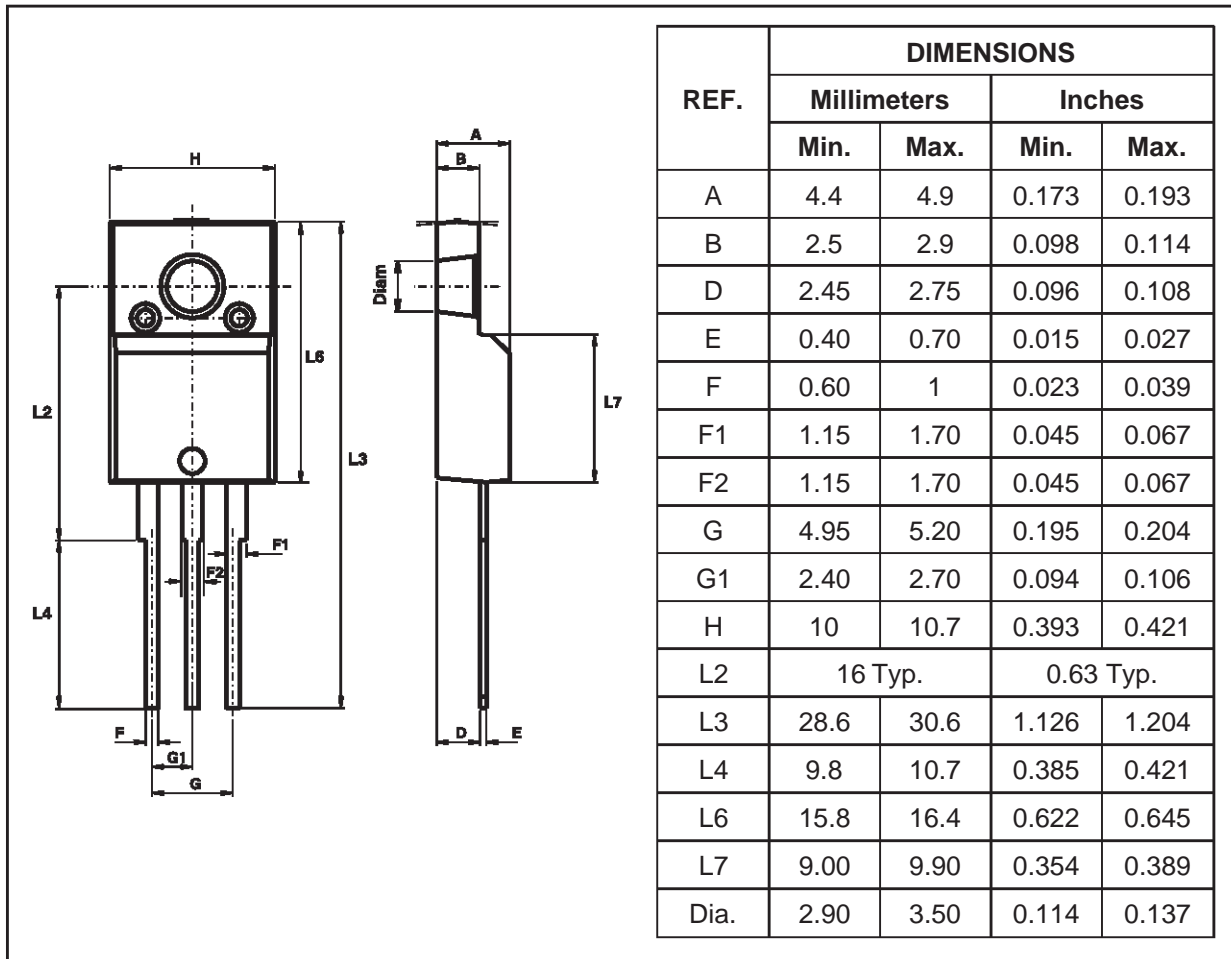

PACKAGE MECHANICAL DATA
ISOWATT220AB (JEDEC compatible)

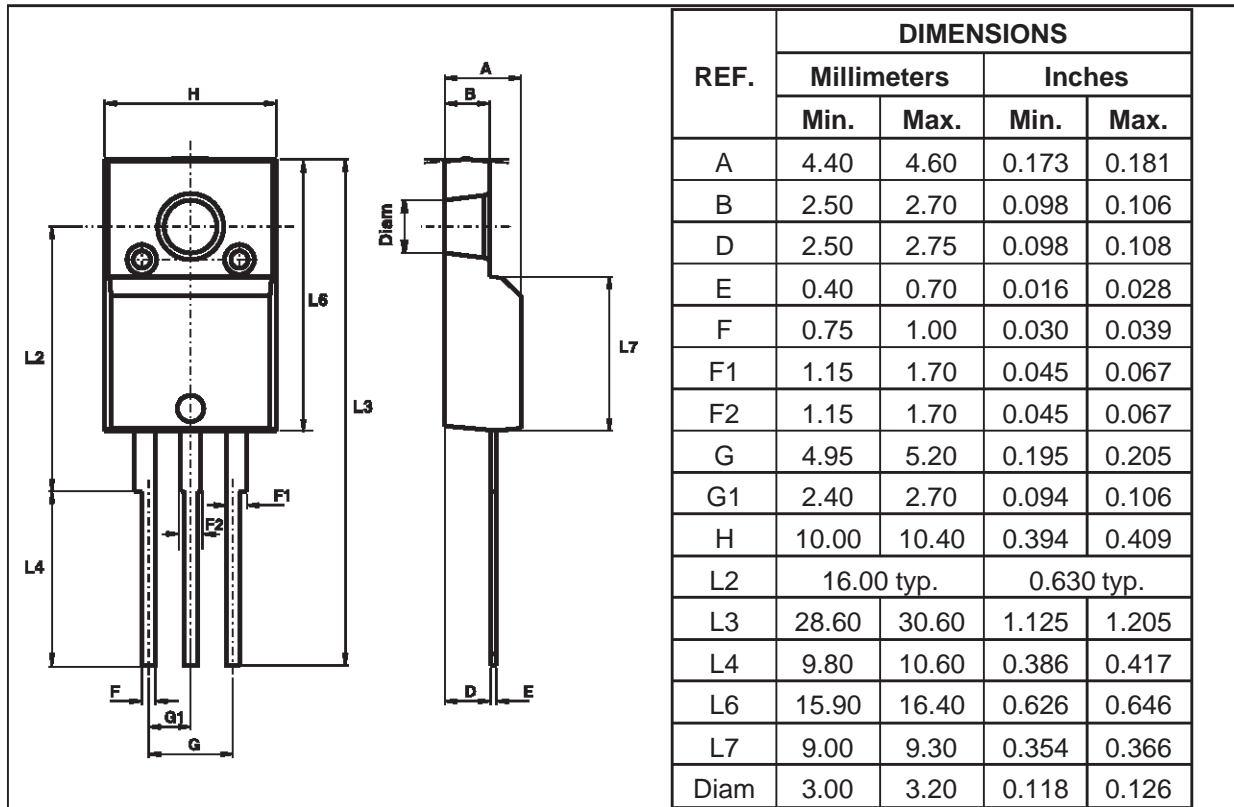

Ordering type	Marking	Package	Weight	Base qty	Delivery mode
STPR1020CB	STPR1020CB	DPAK	0.3g	75	Tube
STPR1020CB-TR	STPR1020CB	DPAK	0.3g	2500	Tape & reel
STPR1020CT	STPR1020CT	TO-220AB	2.23g	50	Tube
STPR1020CF	STPR1020CF	ISOWATT220AB	2.2g	50	Tube
STPR1020CG	STPR1020CG	D ² PAK	1.48g	50	Tube
STPR1020CFP	STPR1020CFP	TO-220FP	2.0g	50	Tube

- Cooling method : by conduction (C)
- Recommended torque value (ISOWATT220AB, TO-220FP): 0.55 N.m.
- Maximum torque value (ISOWATT220AB, TO-220FP): 0.70 N.m.
- Recommended torque value (TO-220AB): 0.8 N.m
- Maximum torque value (TO-220AB): 1.0 N.m.
- Epoxy meets UL94,V0

Information furnished is believed to be accurate and reliable. However, STMicroelectronics assumes no responsibility for the consequences of use of such information nor for any infringement of patents or other rights of third parties which may result from its use. No license is granted by implication or otherwise under any patent or patent rights of STMicroelectronics. Specifications mentioned in this publication are subject to change without notice. This publication supersedes and replaces all information previously supplied. STMicroelectronics products are not authorized for use as critical components in life support devices or systems without express written approval of STMicroelectronics.

The ST logo is a registered trademark of STMicroelectronics
© 2000 STMicroelectronics - Printed in Italy - All rights reserved.

STMicroelectronics GROUP OF COMPANIES
Australia - Brazil - China - Finland - France - Germany - Hong Kong - India - Italy - Japan - Malaysia
Malta - Morocco - Singapore - Spain - Sweden - Switzerland - United Kingdom - U.S.A.

<http://www.st.com>

