

POWER SCHOTTKY RECTIFIER

MAIN PRODUCT CHARACTERISTICS

$I_{F(AV)}$	30 A
V_{RRM}	45 V
T_j (max)	175°C
V_F (max)	0.63 V

FEATURES AND BENEFITS

- VERY SMALL CONDUCTION LOSSES
- NEGLIGIBLE SWITCHING LOSSES
- EXTREMELY FAST SWITCHING
- LOW THERMAL RESISTANCE
- HIGH DISSIPATION MINIATURE PACKAGE

DESCRIPTION

Single Schottky rectifier suited for switchmode power supply and high frequency DC to DC converters.

Packaged in D²PAK surface mount package, this device is intended for use in low voltage, high frequency inverters, free wheeling and polarity protection applications.

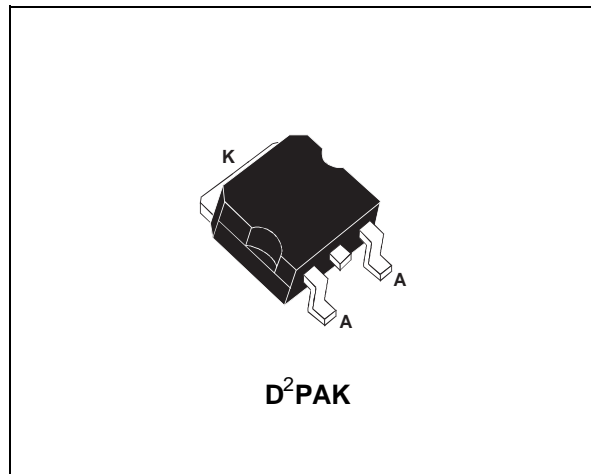

ABSOLUTE RATINGS (limiting values)

Symbol	Parameter		Value	Unit
V_{RRM}	Repetitive peak reverse voltage		45	V
$I_{F(RMS)}$	RMS forward current		50	A
$I_{F(AV)}$	Average forward current	$T_c = 150^\circ\text{C}$ $\delta = 0.5$	30	A
I_{FSM}	Surge non repetitive forward current	$t_p = 10 \text{ ms}$ Sinusoidal	200	A
I_{RRM}	Repetitive peak reverse current	$t_p = 2 \mu\text{s}$ $F = 1 \text{ kHz square}$	1	A
I_{RSM}	Non Repetitive peak reverse current	$t_p = 100 \mu\text{s square}$	3	A
T_{stg}	Storage temperature range		- 65 to + 175	°C
T_j	Maximum operating junction temperature*		175	°C
dV/dt	Critical rate of rise of reverse voltage		10000	V/ μs

* : $\frac{dP_{tot}}{dT_j} < \frac{1}{R_{th(j-a)}}$ thermal runaway condition for a diode on its own heatsink

STPS3045G

THERMAL RESISTANCES

Symbol	Parameter	Value	Unit
$R_{th(j-c)}$	Junction to case	1	$^{\circ}\text{C/W}$

STATIC ELECTRICAL CHARACTERISTICS

Symbol	Parameter	Tests Conditions		Min.	Typ.	Max.	Unit
I_R^*	Reverse leakage current	$T_j = 25^{\circ}\text{C}$	$V_R = V_{RRM}$			500	μA
		$T_j = 125^{\circ}\text{C}$			20	80	mA
V_F^{**}	Forward voltage drop	$T_j = 125^{\circ}\text{C}$	$I_F = 30\text{ A}$		0.53	0.63	V
		$T_j = 25^{\circ}\text{C}$	$I_F = 60\text{ A}$			0.84	
		$T_j = 125^{\circ}\text{C}$	$I_F = 60\text{ A}$		0.68	0.78	

Pulse test : * $t_p = 5\text{ ms}$, $\delta < 2\%$
 ** $t_p = 380\text{ }\mu\text{s}$, $\delta < 2\%$

To evaluate the conduction losses use the following equation :
 $P = 0.48 \times I_{F(AV)} + 0.005 I_{F(RMS)}^2$

Fig. 1: Average forward power dissipation versus average forward current.

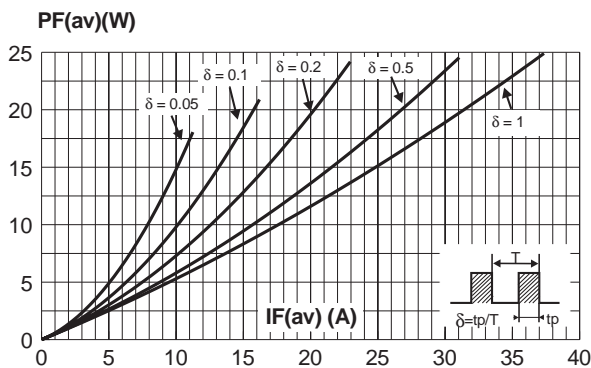

Fig. 2: Average forward current versus ambient temperature ($\delta=0.5$).

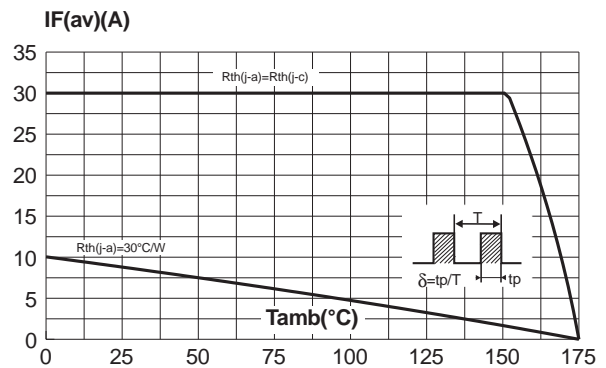

Fig. 3: Non repetitive surge peak forward current versus overload duration (maximum values).

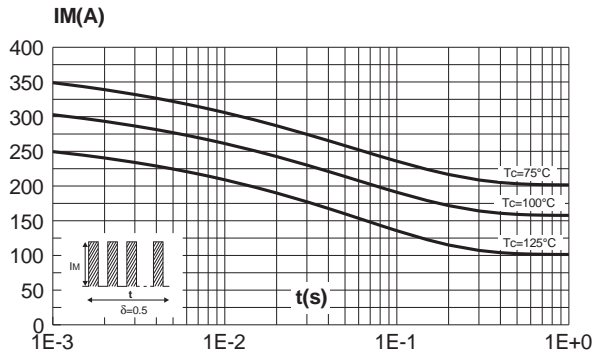

Fig. 4: Relative variation of thermal impedance junction to case versus pulse duration.

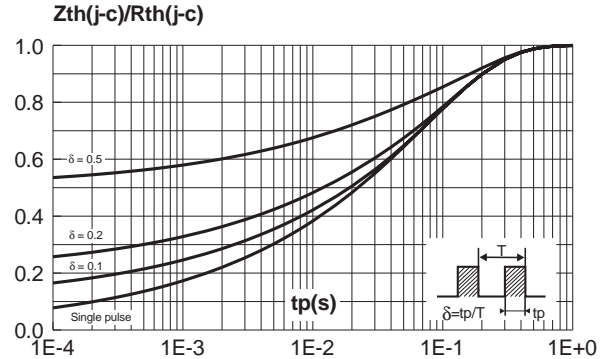

Fig. 5: Reverse leakage current versus reverse voltage applied (typical values)

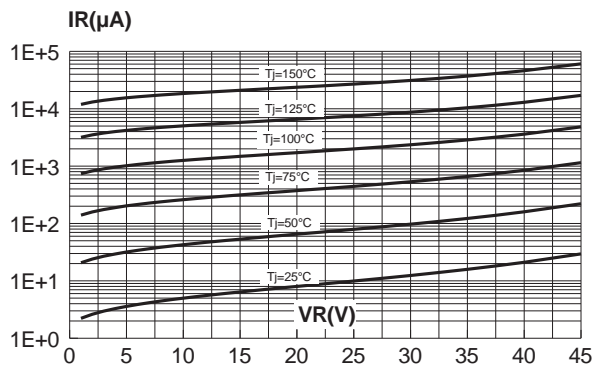

Fig. 6: Junction capacitance versus reverse voltage applied (typical values).

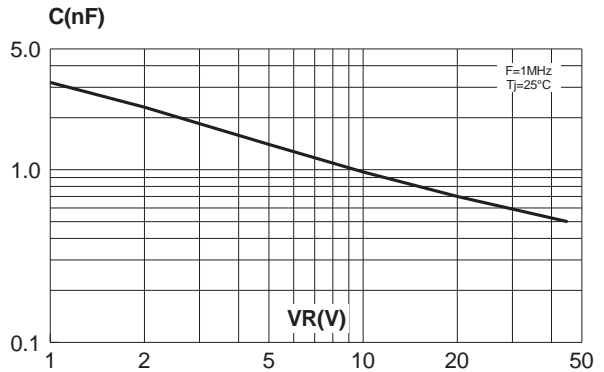

Fig. 7: Forward voltage drop versus forward current (maximum values).

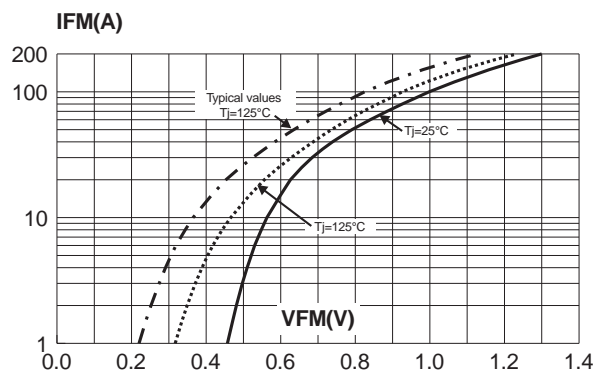
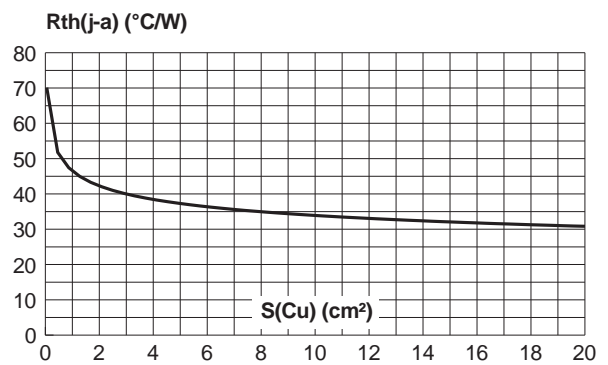
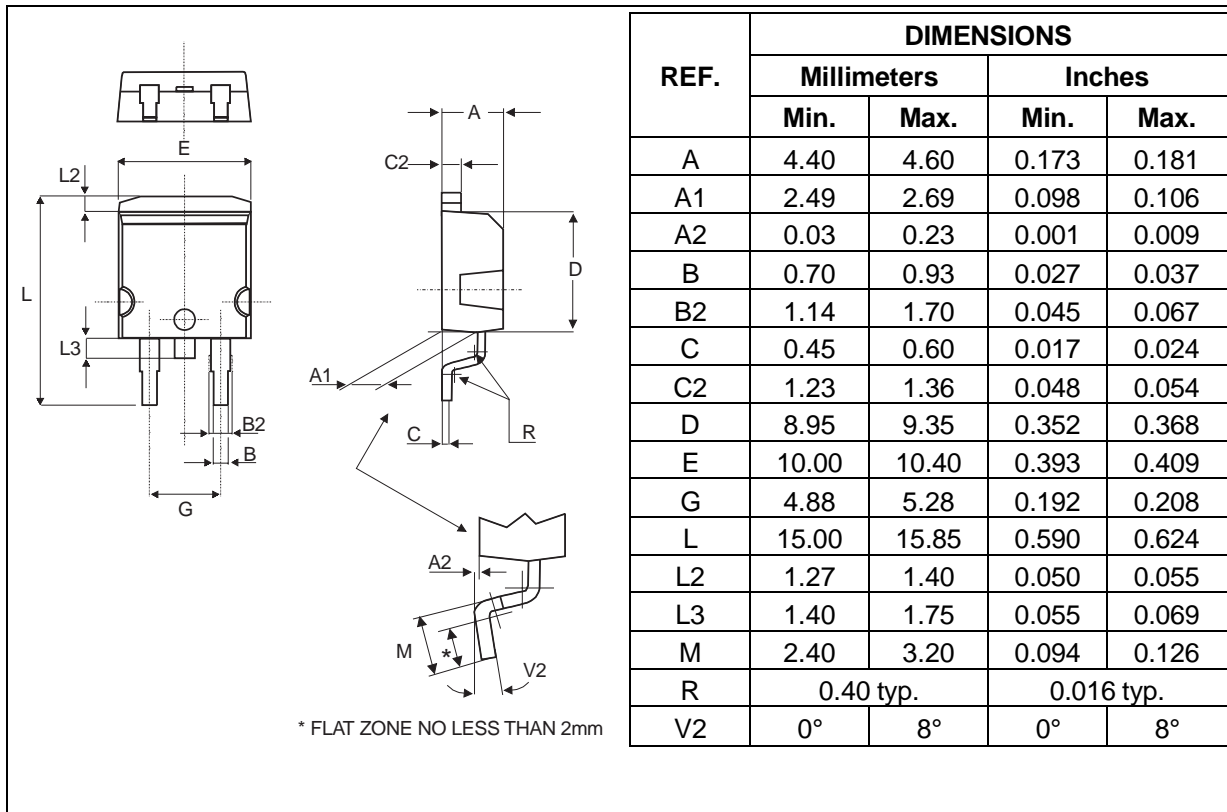

Fig. 8: Thermal resistance junction to ambient versus copper surface under tab (Epoxy printed circuit board, copper thickness: 35μm)



STPS3045G

PACKAGE MECHANICAL DATA D²PAK



FOOTPRINT DIMENSIONS (in millimeters)

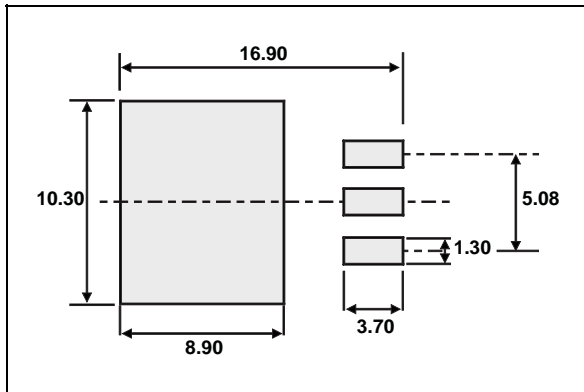

Type	Marking	Package	Weight	Base qty	Delivery mode
STPS3045G	STPS3045G	D ² PAK	1.48g	50	Tube
STPS3045G-TR	STPS3045G	D ² PAK	1.48g	500	Tape & Reel

- Epoxy meets UL94, V0

Information furnished is believed to be accurate and reliable. However, STMicroelectronics assumes no responsibility for the consequences of use of such information nor for any infringement of patents or other rights of third parties which may result from its use. No license is granted by implication or otherwise under any patent or patent rights of STMicroelectronics. Specifications mentioned in this publication are subject to change without notice. This publication supersedes and replaces all information previously supplied. STMicroelectronics products are not authorized for use as critical components in life support devices or systems without express written approval of STMicroelectronics.

The ST logo is a registered trademark of STMicroelectronics

© 1999 STMicroelectronics - Printed in Italy - All rights reserved.

STMicroelectronics GROUP OF COMPANIES

Australia - Brazil - China - Finland - France - Germany - Hong Kong - India - Italy - Japan - Malaysia
Malta - Morocco - Singapore - Spain - Sweden - Switzerland - United Kingdom - U.S.A.

<http://www.st.com>