

N - CHANNEL ENHANCEMENT MODE POWER MOS TRANSISTOR

TYPE	V _{DSS}	R _{DS(on)}	I _D
STP36N05L	60 V	< 0.04 Ω	36 A
STP36N05LFI	60 V	< 0.04 Ω	21 A

- TYPICAL R_{DS(on)} = 0.033 Ω
- AVALANCHE RUGGED TECHNOLOGY
- 100% AVALANCHE TESTED
- REPETITIVE AVALANCHE DATA AT 100°C
- LOW GATE CHARGE
- HIGH CURRENT CAPABILITY
- LOGIC LEVEL COMPATIBLE INPUT
- 175°C OPERATING TEMPERATURE
- APPLICATION ORIENTED CHARACTERIZATION

APPLICATIONS

- HIGH CURRENT, HIGH SPEED SWITCHING
- SOLENOID AND RELAY DRIVERS
- REGULATORS
- DC-DC & DC-AC CONVERTERS
- MOTOR CONTROL, AUDIO AMPLIFIERS
- AUTOMOTIVE ENVIRONMENT (INJECTION, ABS, AIR-BAG, LAMPDRIVERS, Etc.)

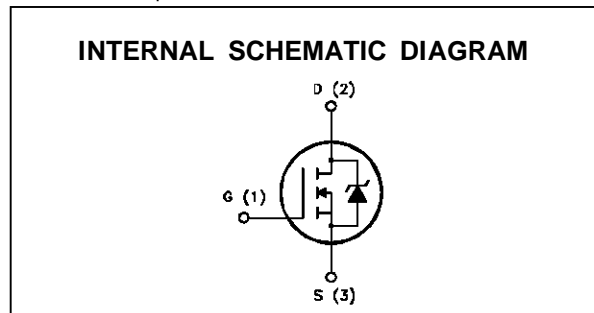

ABSOLUTE MAXIMUM RATINGS

Symbol	Parameter	Value		Unit
		STP36N06L	STP36N06LFI	
V _{DS}	Drain-source Voltage (V _{GS} = 0)	60		V
V _{DGR}	Drain- gate Voltage (R _{GS} = 20 kΩ)	60		V
V _{GS}	Gate-source Voltage	± 15		V
I _D	Drain Current (continuous) at T _c = 25 °C	36	21	A
I _D	Drain Current (continuous) at T _c = 100 °C	25	14	A
I _{DM} (●)	Drain Current (pulsed)	144	144	A
P _{tot}	Total Dissipation at T _c = 25 °C	120	40	W
	Derating Factor	0.8	0.27	W/°C
V _{ISO}	Insulation Withstand Voltage (DC)	—	2000	V
T _{stg}	Storage Temperature	-65 to 175		°C
T _j	Max. Operating Junction Temperature	175		°C

(●) Pulse width limited by safe operating area

THERMAL DATA

		TO-220	ISOWATT220		
R _{thj-case}	Thermal Resistance Junction-case	Max	1.25	3.75	°C/W
R _{thj-amb}	Thermal Resistance Junction-ambient	Max	62.5		°C/W
R _{thc-sink}	Thermal Resistance Case-sink	Typ	0.5		°C/W
T _l	Maximum Lead Temperature For Soldering Purpose		300		°C

AVALANCHE CHARACTERISTICS

Symbol	Parameter	Max Value	Unit
I _{AR}	Avalanche Current, Repetitive or Not-Repetitive (pulse width limited by T _j max, δ < 1%)	36	A
E _{AS}	Single Pulse Avalanche Energy (starting T _j = 25 °C, I _D = I _{AR} , V _{DD} = 25 V)	240	mJ
E _{AR}	Repetitive Avalanche Energy (pulse width limited by T _j max, δ < 1%)	60	mJ
I _{AR}	Avalanche Current, Repetitive or Not-Repetitive (T _c = 100 °C, pulse width limited by T _j max, δ < 1%)	25	A

ELECTRICAL CHARACTERISTICS (T_{case} = 25 °C unless otherwise specified)

OFF

Symbol	Parameter	Test Conditions	Min.	Typ.	Max.	Unit
V _{(BR)DSS}	Drain-source Breakdown Voltage	I _D = 250 μA V _{GS} = 0	60			V
I _{DSS}	Zero Gate Voltage Drain Current (V _{GS} = 0)	V _{DS} = Max Rating V _{DS} = Max Rating x 0.8 T _c = 125 °C			1 10	μA μA
I _{GSS}	Gate-body Leakage Current (V _{DS} = 0)	V _{GS} = ± 15 V			± 100	nA

ON (*)

Symbol	Parameter	Test Conditions	Min.	Typ.	Max.	Unit
V _{GS(th)}	Gate Threshold Voltage	V _{DS} = V _{GS} I _D = 250 μA	1	1.6	2.5	V
R _{DS(on)}	Static Drain-source On Resistance	V _{GS} = 5 V I _D = 18 A		0.033	0.04	Ω
I _{D(on)}	On State Drain Current	V _{DS} > I _{D(on)} x R _{DS(on)max} V _{GS} = 10 V	36			A

DYNAMIC

Symbol	Parameter	Test Conditions	Min.	Typ.	Max.	Unit
g _{fs} (*)	Forward Transconductance	V _{DS} > I _{D(on)} x R _{DS(on)max} I _D = 18 A	12	24		S
C _{iss}	Input Capacitance	V _{DS} = 25 V f = 1 MHz V _{GS} = 0		1350	1800	pF
C _{oss}	Output Capacitance			450	600	pF
C _{rss}	Reverse Transfer Capacitance			130	200	pF

ELECTRICAL CHARACTERISTICS (continued)

SWITCHING ON

Symbol	Parameter	Test Conditions	Min.	Typ.	Max.	Unit
$t_{d(on)}$ t_r	Turn-on Time Rise Time	$V_{DD} = 25\text{ V}$ $I_D = 18\text{ A}$ $R_G = 50\ \Omega$ $V_{GS} = 5\text{ V}$ (see test circuit, figure 3)		90 550	130 800	ns ns
$(di/dt)_{on}$	Turn-on Current Slope	$V_{DD} = 40\text{ V}$ $I_D = 36\text{ A}$ $R_G = 50\ \Omega$ $V_{GS} = 5\text{ V}$ (see test circuit, figure 5)		85		A/ μ s
Q_g Q_{gs} Q_{gd}	Total Gate Charge Gate-Source Charge Gate-Drain Charge	$V_{DD} = 40\text{ V}$ $I_D = 36\text{ A}$ $V_{GS} = 5\text{ V}$		35 11 19	50	nC nC nC

SWITCHING OFF

Symbol	Parameter	Test Conditions	Min.	Typ.	Max.	Unit
$t_{r(Voff)}$ t_f t_c	Off-voltage Rise Time Fall Time Cross-over Time	$V_{DD} = 40\text{ V}$ $I_D = 36\text{ A}$ $R_G = 50\ \Omega$ $V_{GS} = 5\text{ V}$ (see test circuit, figure 5)		110 180 310	160 260 450	ns ns ns

SOURCE DRAIN DIODE

Symbol	Parameter	Test Conditions	Min.	Typ.	Max.	Unit
I_{SD} $I_{SDM}(\bullet)$	Source-drain Current Source-drain Current (pulsed)				36 144	A A
$V_{SD} (*)$	Forward On Voltage	$I_{SD} = 36\text{ A}$ $V_{GS} = 0$			1.6	V
t_{rr} Q_{rr} I_{RRM}	Reverse Recovery Time Reverse Recovery Charge Reverse Recovery Current	$I_{SD} = 36\text{ A}$ $di/dt = 100\text{ A}/\mu\text{s}$ $V_{DD} = 30\text{ V}$ $T_j = 150\text{ }^\circ\text{C}$ (see test circuit, figure 5)		100 0.27 5.5		ns μ C A

(*) Pulsed: Pulse duration = 300 μ s, duty cycle 1.5 %

(\bullet) Pulse width limited by safe operating area

Safe Operating Areas For TO-220

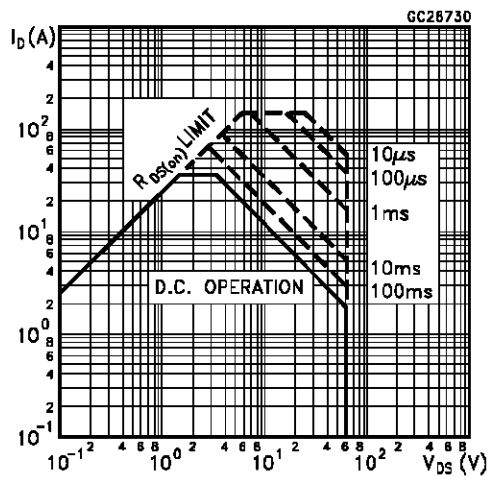

Safe Operating Areas For ISOWATT220

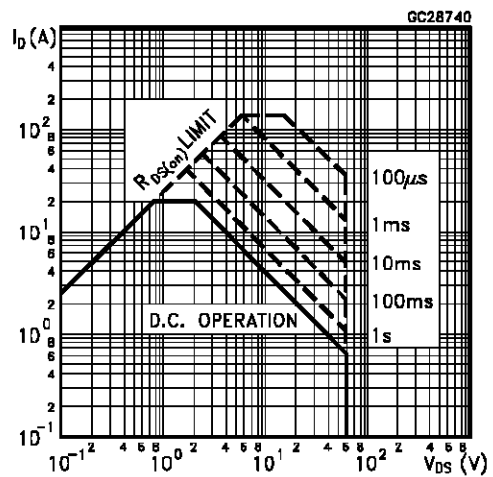

Thermal Impedance For TO-220

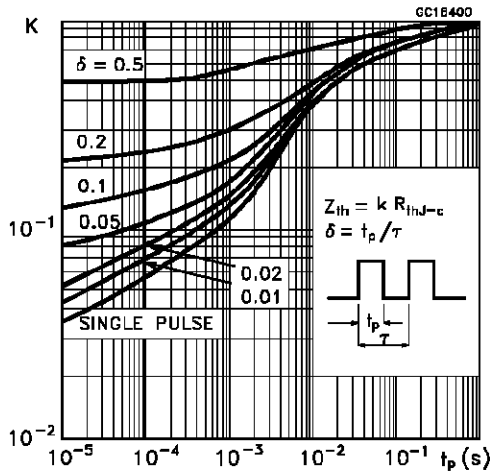

Thermal Impedance For ISOWATT220

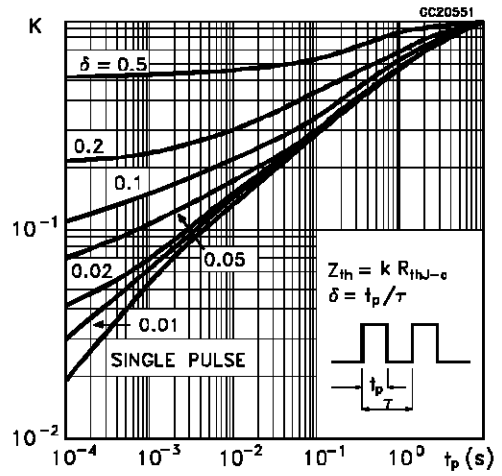

Derating Curve For TO-220

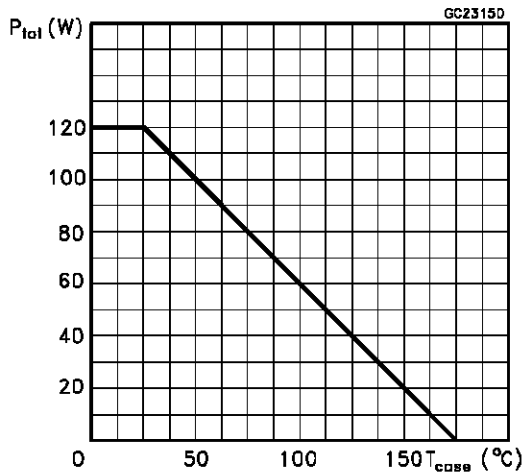

Derating Curve For ISOWATT220

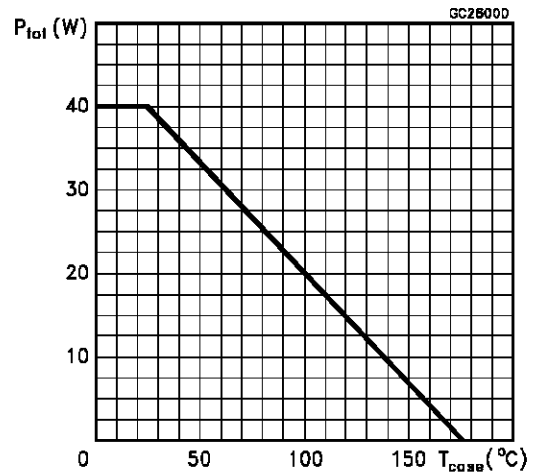

Output Characteristics

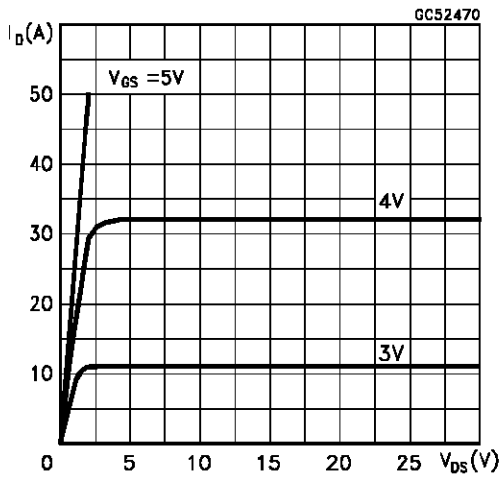

Transfer Characteristics

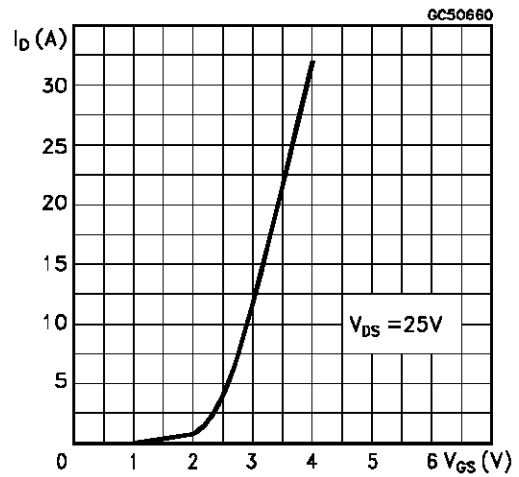

Transconductance

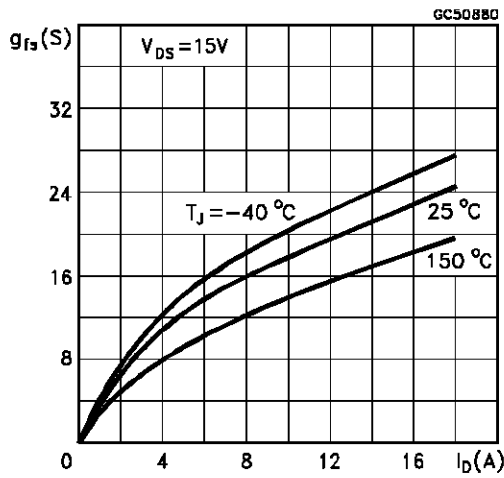

Static Drain-source On Resistance

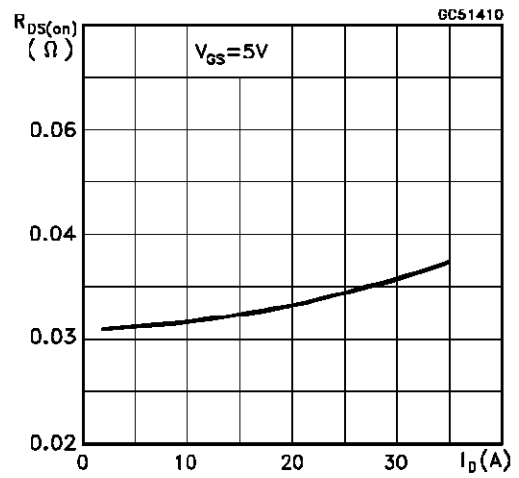

Gate Charge vs Gate-source Voltage

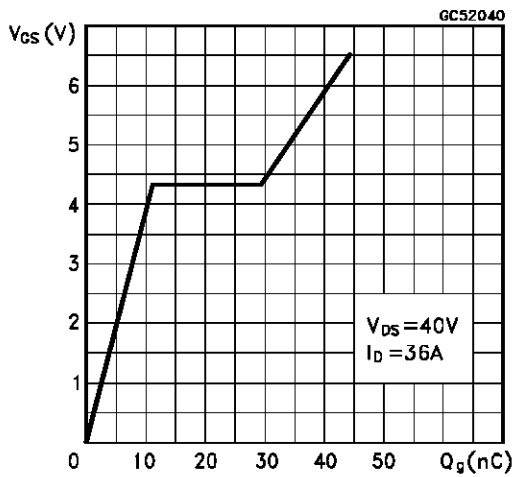

Capacitance Variations

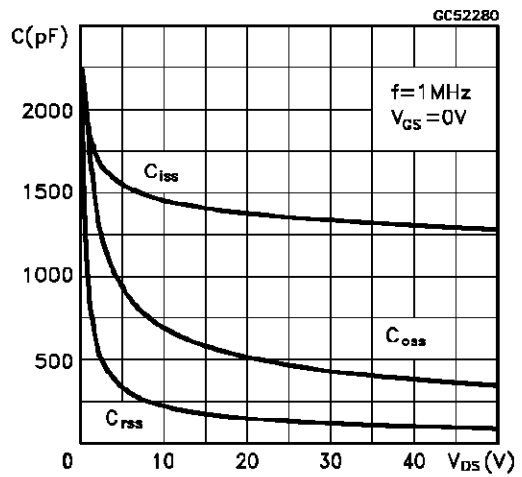

Normalized Gate Threshold Voltage vs Temperature

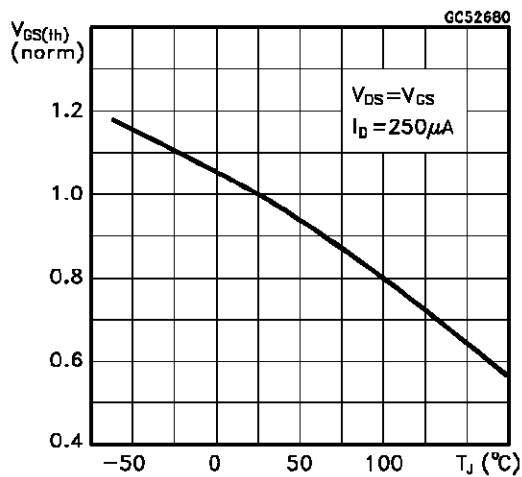

Normalized On Resistance vs Temperature

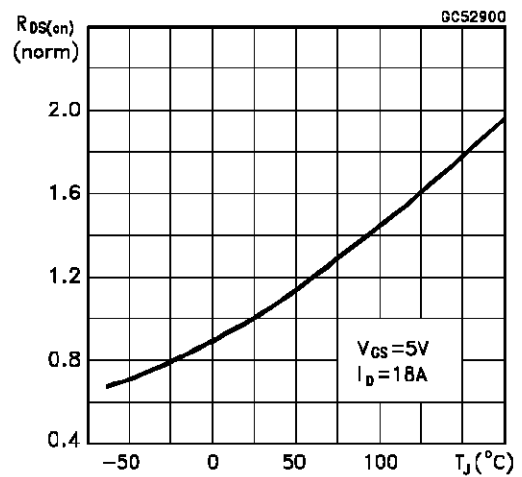

Turn-on Current Slope

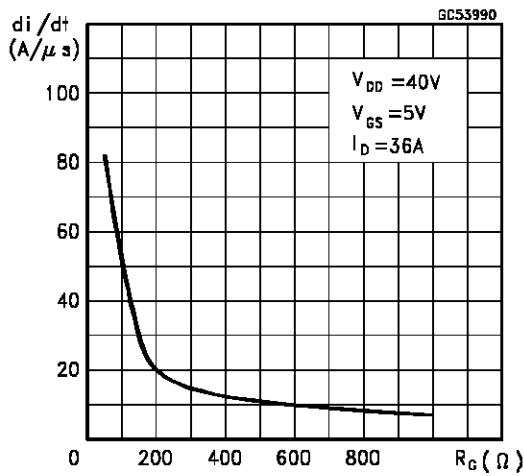

Turn-off Drain-source Voltage Slope

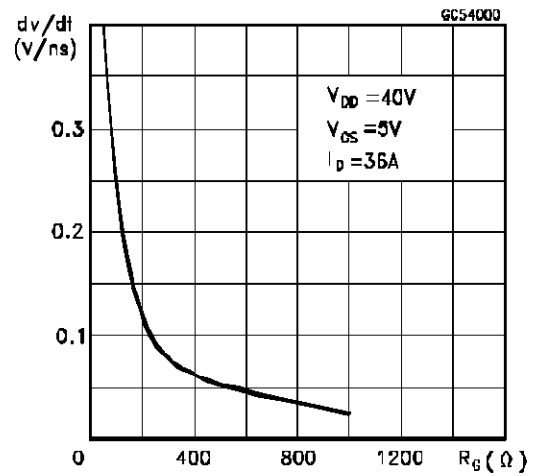

Cross-over Time

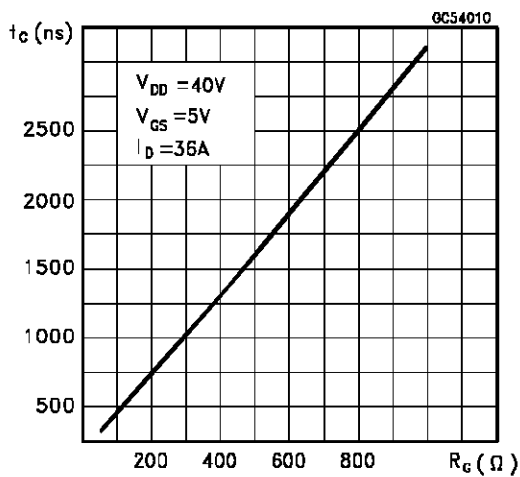

Switching Safe Operating Area

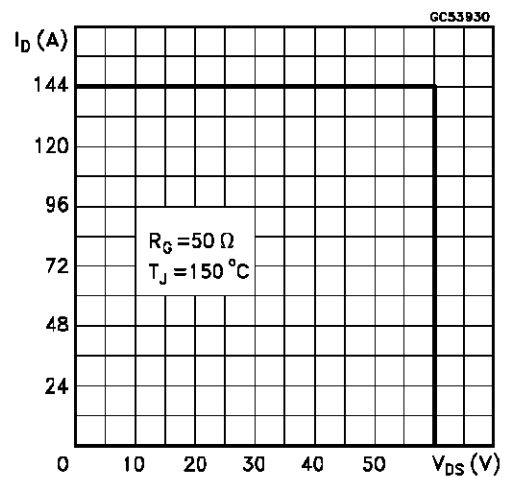

Accidental Overload Area

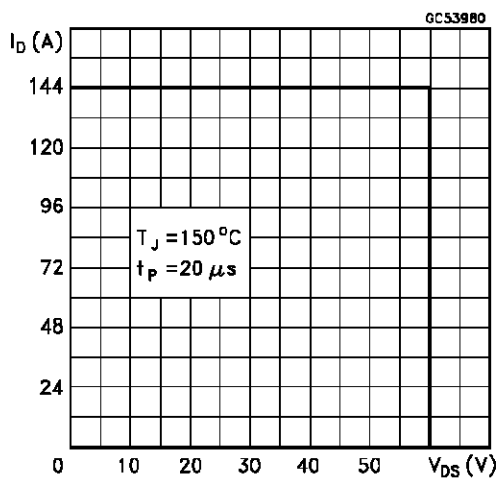

Source-drain Diode Forward Characteristics

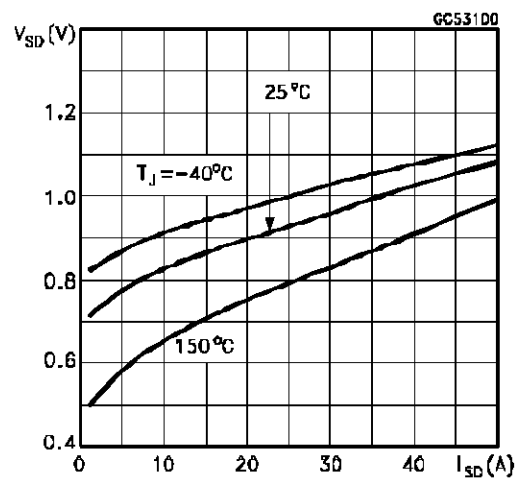

Fig. 1: Unclamped Inductive Load Test Circuits



Fig. 2: Unclamped Inductive Waveforms



Fig. 3: Switching Times Test Circuits For Resistive Load



Fig. 4: Gate Charge Test Circuit

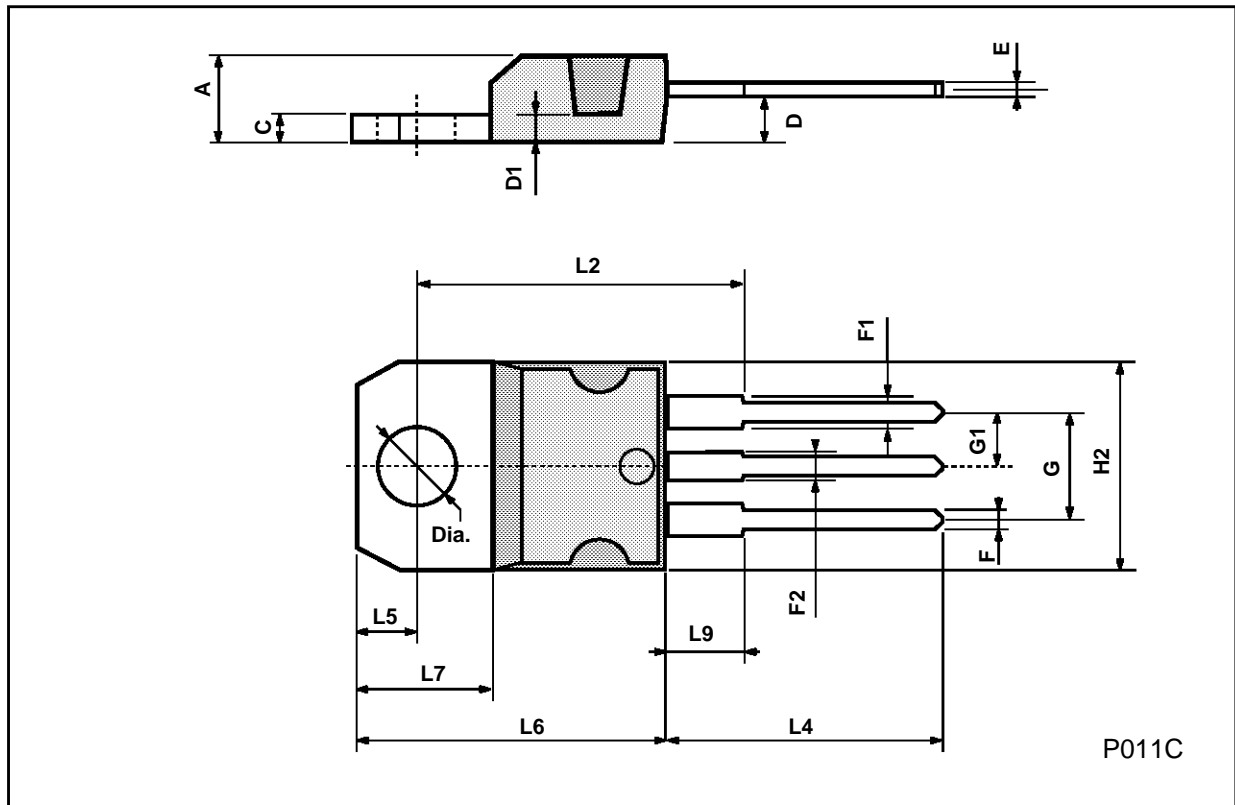

Fig. 5: Test Circuit For Inductive Load Switching And Diode Reverse Recovery Time



TO-220 MECHANICAL DATA

DIM.	mm			inch		
	MIN.	TYP.	MAX.	MIN.	TYP.	MAX.
A	4.40		4.60	0.173		0.181
C	1.23		1.32	0.048		0.051
D	2.40		2.72	0.094		0.107
D1		1.27			0.050	
E	0.49		0.70	0.019		0.027
F	0.61		0.88	0.024		0.034
F1	1.14		1.70	0.044		0.067
F2	1.14		1.70	0.044		0.067
G	4.95		5.15	0.194		0.203
G1	2.4		2.7	0.094		0.106
H2	10.0		10.40	0.393		0.409
L2		16.4			0.645	
L4	13.0		14.0	0.511		0.551
L5	2.65		2.95	0.104		0.116
L6	15.25		15.75	0.600		0.620
L7	6.2		6.6	0.244		0.260
L9	3.5		3.93	0.137		0.154
DIA.	3.75		3.85	0.147		0.151



ISOWATT220 MECHANICAL DATA

DIM.	mm			inch		
	MIN.	TYP.	MAX.	MIN.	TYP.	MAX.
A	4.4		4.6	0.173		0.181
B	2.5		2.7	0.098		0.106
D	2.5		2.75	0.098		0.108
E	0.4		0.7	0.015		0.027
F	0.75		1	0.030		0.039
F1	1.15		1.7	0.045		0.067
F2	1.15		1.7	0.045		0.067
G	4.95		5.2	0.195		0.204
G1	2.4		2.7	0.094		0.106
H	10		10.4	0.393		0.409
L2		16			0.630	
L3	28.6		30.6	1.126		1.204
L4	9.8		10.6	0.385		0.417
L6	15.9		16.4	0.626		0.645
L7	9		9.3	0.354		0.366
Ø	3		3.2	0.118		0.126



Information furnished is believed to be accurate and reliable. However, SGS-THOMSON Microelectronics assumes no responsibility for the consequences of use of such information nor for any infringement of patents or other rights of third parties which may result from its use. No license is granted by implication or otherwise under any patent or patent rights of SGS-THOMSON Microelectronics. Specifications mentioned in this publication are subject to change without notice. This publication supersedes and replaces all information previously supplied. SGS-THOMSON Microelectronics products are not authorized for use as critical components in life support devices or systems without express written approval of SGS-THOMSON Microelectronics.

© 1996 SGS-THOMSON Microelectronics - Printed in Italy - All Rights Reserved

SGS-THOMSON Microelectronics GROUP OF COMPANIES

Australia - Brazil - Canada - China - France - Germany - Hong Kong - Italy - Japan - Korea - Malaysia - Malta - Morocco - The Netherlands - Singapore - Spain - Sweden - Switzerland - Taiwan - Thailand - United Kingdom - U.S.A