



# STW10NB60

## N - CHANNEL 600V - 0.69Ω - 10A - TO-247 PowerMESH™ MOSFET

TYPE	V <sub>DSS</sub>	R <sub>DS(on)</sub>	I <sub>D</sub>
STW10NB60	600 V	< 0.8 Ω	10 A

- TYPICAL R<sub>DS(on)</sub> = 0.69 Ω
- EXTREMELY HIGH dv/dt CAPABILITY
- 100% AVALANCHE TESTED
- VERY LOW INTRINSIC CAPACITANCES
- GATE CHARGE MINIMIZED

### DESCRIPTION

Using the latest high voltage MESH OVERLAY™ process, STMicroelectronics has designed an advanced family of power MOSFETs with outstanding performances. The new patent pending strip layout coupled with the Company's proprietary edge termination structure, gives the lowest R<sub>DS(on)</sub> per area, exceptional avalanche and dv/dt capabilities and unrivalled gate charge and switching characteristics.

### APPLICATIONS

- SWITCH MODE POWER SUPPLIES (SMPS)
- DC-AC CONVERTERS FOR WELDING EQUIPMENT AND UNINTERRUPTIBLE POWER SUPPLIES AND MOTOR DRIVE
- HIGH CURRENT, HIGH SPEED SWITCHING

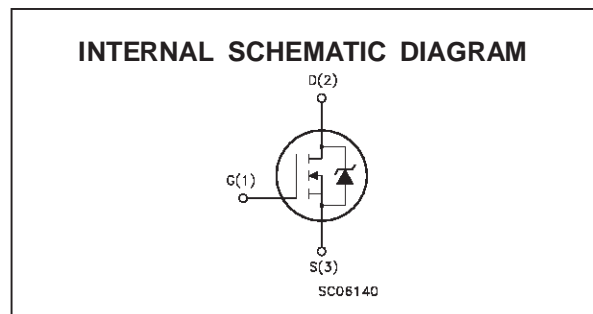
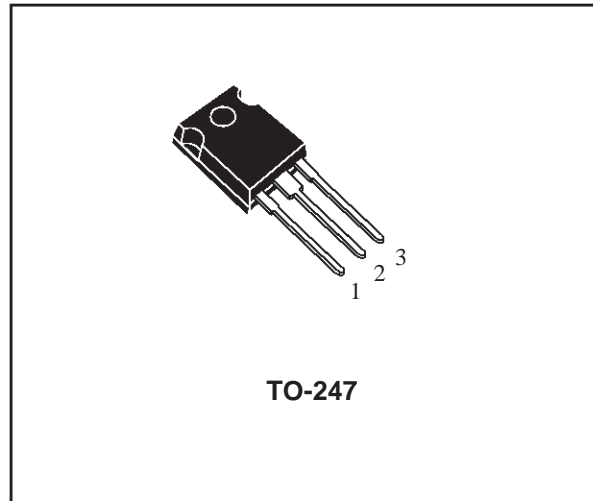

### ABSOLUTE MAXIMUM RATINGS

Symbol	Parameter	Value	Unit
V <sub>DS</sub>	Drain-source Voltage (V <sub>GS</sub> = 0)	600	V
V <sub>DGR</sub>	Drain- gate Voltage (R <sub>GS</sub> = 20 kΩ)	600	V
V <sub>GS</sub>	Gate-source Voltage	± 30	V
I <sub>D</sub>	Drain Current (continuous) at T <sub>c</sub> = 25 °C	10	A
I <sub>D</sub>	Drain Current (continuous) at T <sub>c</sub> = 100 °C	6.2	A
I <sub>DM</sub> (•)	Drain Current (pulsed)	40	A
P <sub>tot</sub>	Total Dissipation at T <sub>c</sub> = 25 °C	160	W
	Derating Factor	1.28	W/°C
dv/dt(1)	Peak Diode Recovery voltage slope	4.5	V/ns
T <sub>stg</sub>	Storage Temperature	-65 to 150	°C
T <sub>j</sub>	Max. Operating Junction Temperature	150	°C

(•) Pulse width limited by safe operating area

(1) I<sub>SD</sub> ≤ 10A, di/dt ≤ 200 A/μs, V<sub>DD</sub> ≤ V<sub>(BR)DSS</sub>, T<sub>j</sub> ≤ T<sub>JMAX</sub>

## STW10NB60

### THERMAL DATA

R <sub>thj-case</sub>	Thermal Resistance Junction-case	Max	0.78	°C/W
R <sub>thj-amb</sub>	Thermal Resistance Junction-ambient	Max	30	°C/W
R <sub>thc-sink</sub>	Thermal Resistance Case-sink	Typ	0.1	°C/W
T <sub>I</sub>	Maximum Lead Temperature For Soldering Purpose		300	°C

### AVALANCHE CHARACTERISTICS

Symbol	Parameter	Max Value	Unit
I <sub>AR</sub>	Avalanche Current, Repetitive or Not-Repetitive (pulse width limited by T <sub>j</sub> max, δ < 1%)	10	A
E <sub>AS</sub>	Single Pulse Avalanche Energy (starting T <sub>j</sub> = 25 °C, I <sub>D</sub> = I <sub>AR</sub> , V <sub>DD</sub> = 50 V)	850	mJ

### ELECTRICAL CHARACTERISTICS (T<sub>case</sub> = 25 °C unless otherwise specified)

OFF

Symbol	Parameter	Test Conditions	Min.	Typ.	Max.	Unit
V <sub>(BR)DSS</sub>	Drain-source Breakdown Voltage	I <sub>D</sub> = 250 μA V <sub>GS</sub> = 0	600			V
I <sub>DSS</sub>	Zero Gate Voltage Drain Current (V <sub>GS</sub> = 0)	V <sub>DS</sub> = Max Rating V <sub>DS</sub> = Max Rating T <sub>c</sub> = 100 °C			1 50	μA μA
I <sub>GSS</sub>	Gate-body Leakage Current (V <sub>DS</sub> = 0)	V <sub>GS</sub> = ± 30 V			± 100	nA

ON (\*)

Symbol	Parameter	Test Conditions	Min.	Typ.	Max.	Unit
V <sub>GS(th)</sub>	Gate Threshold Voltage	V <sub>DS</sub> = V <sub>GS</sub> I <sub>D</sub> = 250 μA	3	4	5	V
R <sub>DS(on)</sub>	Static Drain-source On Resistance	V <sub>GS</sub> = 10V I <sub>D</sub> = 4 A		0.69	0.8	Ω
I <sub>D(on)</sub>	On State Drain Current	V <sub>DS</sub> > I <sub>D(on)</sub> × R <sub>DS(on)max</sub> V <sub>GS</sub> = 10 V	10			A

### DYNAMIC

Symbol	Parameter	Test Conditions	Min.	Typ.	Max.	Unit
g <sub>fs</sub> (*)	Forward Transconductance	V <sub>DS</sub> > I <sub>D(on)</sub> × R <sub>DS(on)max</sub> I <sub>D</sub> = 17 A	3	6.5		S
C <sub>iss</sub>	Input Capacitance	V <sub>DS</sub> = 25 V f = 1 MHz V <sub>GS</sub> = 0		1480	1924	pF
C <sub>oss</sub>	Output Capacitance			210	273	pF
C <sub>rss</sub>	Reverse Transfer Capacitance			25	33	pF

**ELECTRICAL CHARACTERISTICS** (continued)

**SWITCHING ON**

Symbol	Parameter	Test Conditions	Min.	Typ.	Max.	Unit
$t_{d(on)}$	Turn-on Time	$V_{DD} = 300\text{ V}$ $I_D = 4.5\text{ A}$		25	35	ns
$t_r$	Rise Time	$R_G = 4.7\ \Omega$ $V_{GS} = 10\text{ V}$ (see test circuit, figure 3)		11	15	ns
$Q_g$	Total Gate Charge	$V_{DD} = 480\text{ V}$ $I_D = 9\text{ A}$ $V_{GS} = 10\text{ V}$		40	56	nC
$Q_{gs}$	Gate-Source Charge	$R_G = 4.7\ \Omega$ $V_{GS} = 10\text{ V}$		10.5		nC
$Q_{gd}$	Gate-Drain Charge			17.5		nC

**SWITCHING OFF**

Symbol	Parameter	Test Conditions	Min.	Typ.	Max.	Unit
$t_{r(Voff)}$	Off-voltage Rise Time	$V_{DD} = 480\text{ V}$ $I_D = 9\text{ A}$		12	17	ns
$t_f$	Fall Time	$R_G = 4.7\ \Omega$ $V_{GS} = 10\text{ V}$ (see test circuit, figure 5)		10	14	ns
$t_c$	Cross-over Time			21	29	ns

**SOURCE DRAIN DIODE**

Symbol	Parameter	Test Conditions	Min.	Typ.	Max.	Unit
$I_{SD}$	Source-drain Current				10	A
$I_{SDM}(\bullet)$	Source-drain Current (pulsed)				40	A
$V_{SD}(\ast)$	Forward On Voltage	$I_{SD} = 10\text{ A}$ $V_{GS} = 0$			1.6	V
$t_{rr}$	Reverse Recovery Time	$I_{SD} = 9\text{ A}$ $di/dt = 100\text{ A}/\mu\text{s}$ $V_{DD} = 100\text{ V}$ $T_j = 150\text{ }^\circ\text{C}$ (see test circuit, figure 5)		600		ns
$Q_{rr}$	Reverse Recovery Charge			5.4		$\mu\text{C}$
$I_{RRM}$	Reverse Recovery Current			18		A

(\*) Pulsed: Pulse duration = 300  $\mu\text{s}$ , duty cycle 1.5 %

(•) Pulse width limited by safe operating area

**Safe Operating Area**

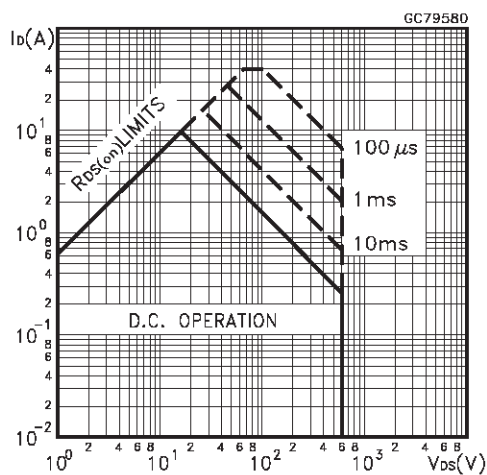

**Thermal Impedance**

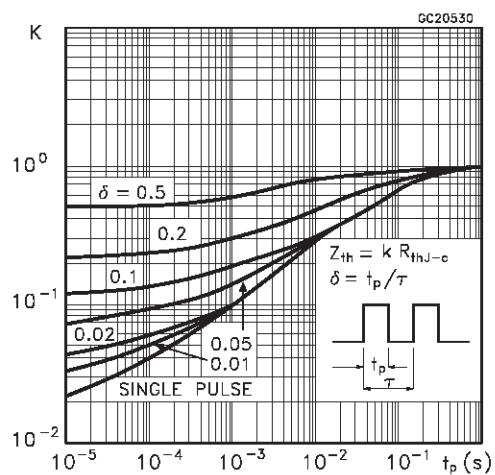

Output Characteristics

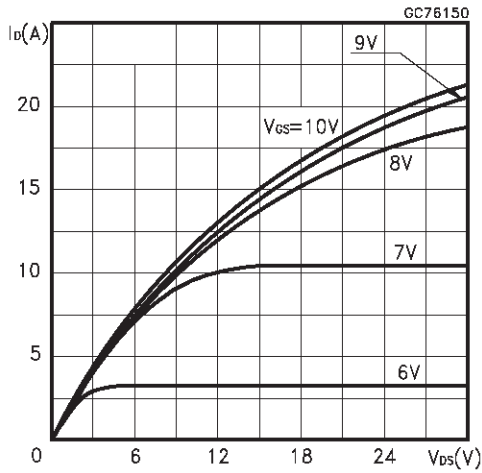

Transfer Characteristics

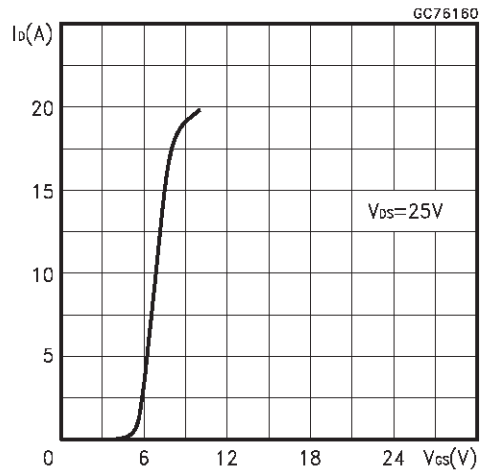

Transconductance

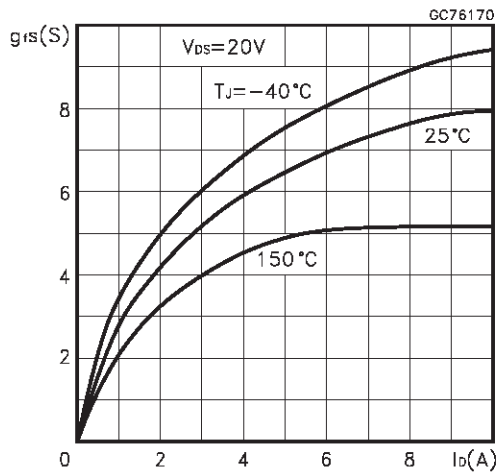

Static Drain-source On Resistance

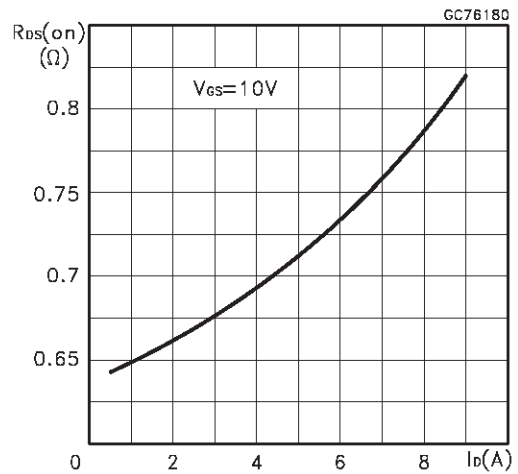

Gate Charge vs Gate-source Voltage

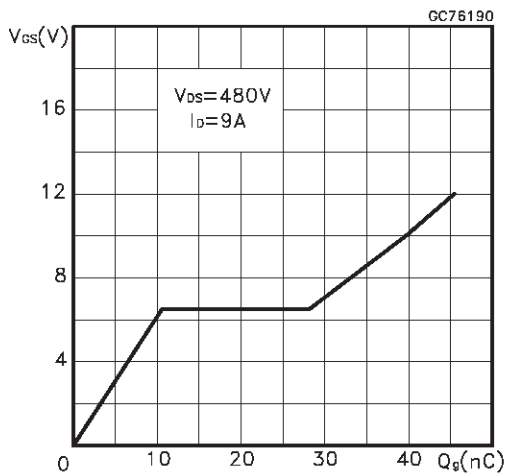

Capacitance Variations

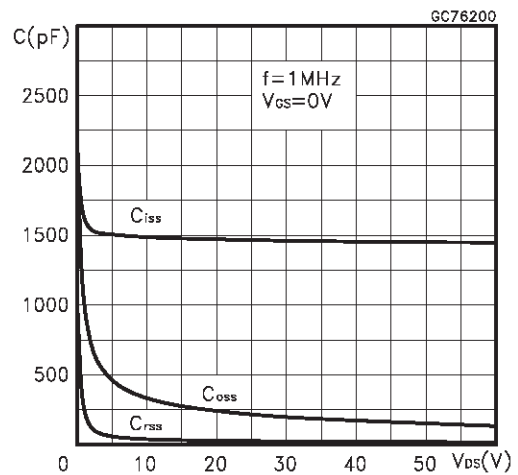

Normalized Gate Threshold Voltage vs Temperature

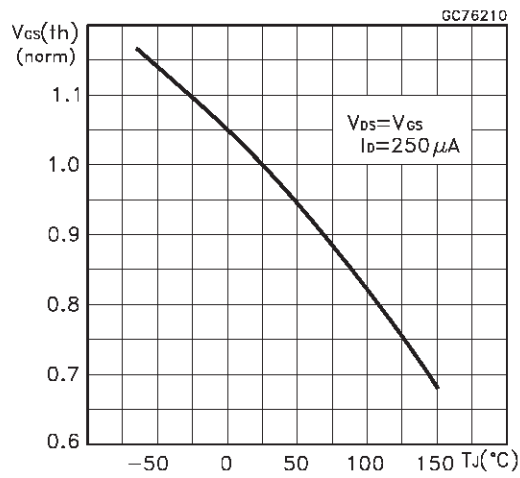

Normalized On Resistance vs Temperature

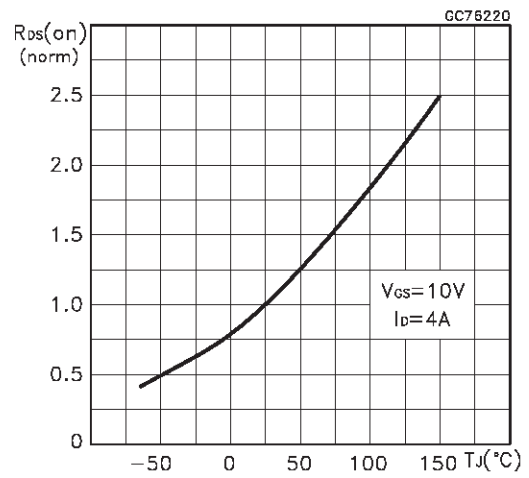

Source-drain Diode Forward Characteristics

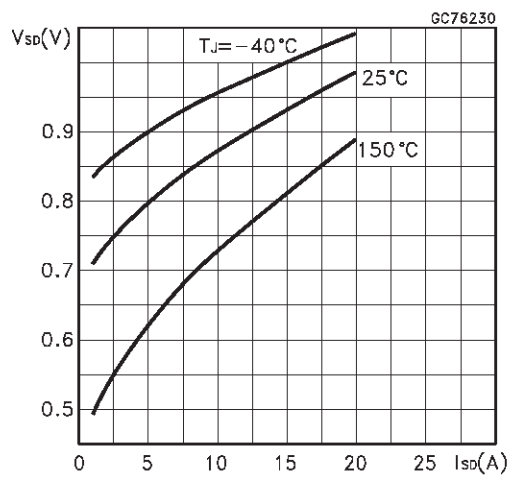

Fig. 1: Unclamped Inductive Load Test Circuit



Fig. 2: Unclamped Inductive Waveform



Fig. 3: Switching Times Test Circuits For Resistive Load



Fig. 4: Gate Charge test Circuit

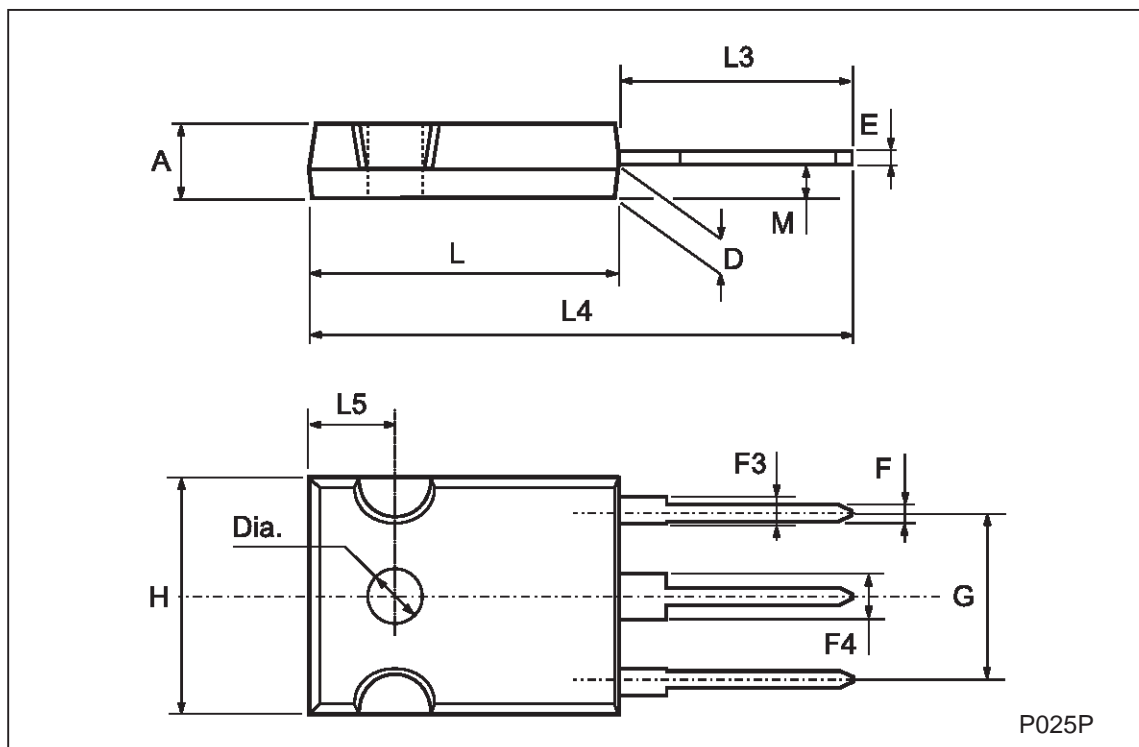

Fig. 5: Test Circuit For Inductive Load Switching And Diode Recovery Times



## TO-247 MECHANICAL DATA

DIM.	mm			inch		
	MIN.	TYP.	MAX.	MIN.	TYP.	MAX.
A	4.7		5.3	0.185		0.209
D	2.2		2.6	0.087		0.102
E	0.4		0.8	0.016		0.031
F	1		1.4	0.039		0.055
F3	2		2.4	0.079		0.094
F4	3		3.4	0.118		0.134
G		10.9			0.429	
H	15.3		15.9	0.602		0.626
L	19.7		20.3	0.776		0.779
L3	14.2		14.8	0.559	0.413	0.582
L4		34.6			1.362	
L5		5.5			0.217	
M	2		3	0.079		0.118
Dia	3.55		3.65	0.140		0.144



Information furnished is believed to be accurate and reliable. However, STMicroelectronics assumes no responsibility for the consequences of use of such information nor for any infringement of patents or other rights of third parties which may result from its use. No license is granted by implication or otherwise under any patent or patent rights of STMicroelectronics. Specification mentioned in this publication are subject to change without notice. This publication supersedes and replaces all information previously supplied. STMicroelectronics products are not authorized for use as critical components in life support devices or systems without express written approval of STMicroelectronics.

The ST logo is a trademark of STMicroelectronics

© 1998 STMicroelectronics – Printed in Italy – All Rights Reserved  
STMicroelectronics GROUP OF COMPANIES

Australia - Brazil - Canada - China - France - Germany - Italy - Japan - Korea - Malaysia - Malta - Mexico - Morocco - The Netherlands -  
Singapore - Spain - Sweden - Switzerland - Taiwan - Thailand - United Kingdom - U.S.A.

<http://www.st.com>