

## COMPLEMENTARY SILICON POWER DARLINGTON TRANSISTORS

- SGS-THOMSON PREFERRED SALESTYPES
- LOW BASE-DRIVE REQUIREMENTS
- INTEGRATED ANTIPARALLEL COLLECTOR-EMITTER DIODE
- SURFACE-MOUNTING TO-252 (DPAK) POWER PACKAGE IN TAPE & REEL (SUFFIX "T4")
- ELECTRICAL SIMILAR TO TIP112 AND TIP117

### APPLICATIONS

- GENERAL PURPOSE SWITCHING AND AMPLIFIER

### DESCRIPTION

The MJD112 and MJD117 form complementary PNP - NPN pairs.

They are manufactured using Epitaxial Base technology for cost-effective performance.

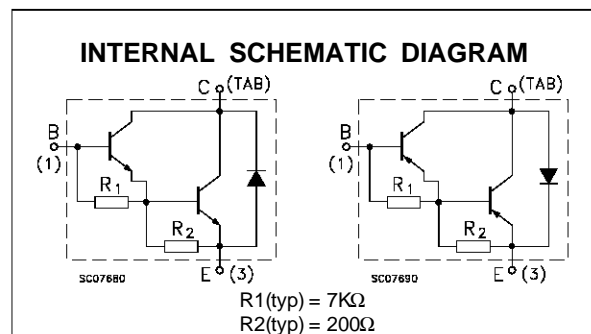
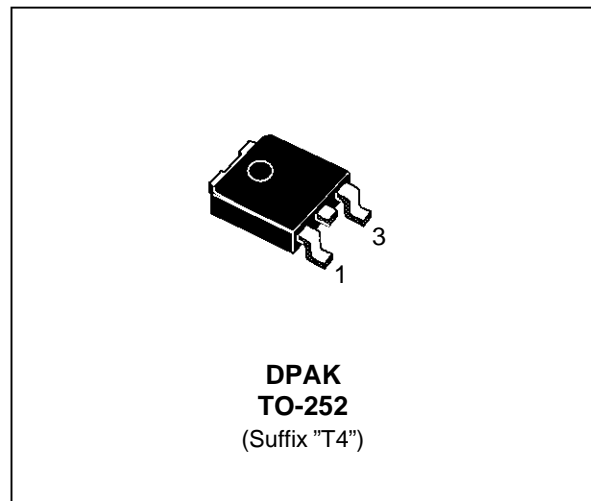

### ABSOLUTE MAXIMUM RATINGS

Symbol	Parameter	Value	Unit
V <sub>CE0</sub>	Collector-Emitter Voltage (I <sub>E</sub> = 0)	100	V
V <sub>CEO</sub>	Collector-Emitter Voltage (I <sub>B</sub> = 0)	100	V
V <sub>EBO</sub>	Emitter-Base Voltage (I <sub>C</sub> = 0)	5	V
I <sub>C</sub>	Collector Current	2	A
I <sub>CM</sub>	Collector Peak Current (t <sub>p</sub> < 5 ms)	4	A
I <sub>B</sub>	Base Current	0.05	A
P <sub>tot</sub>	Total Dissipation at T <sub>c</sub> = 25 °C	20	W
T <sub>stg</sub>	Storage Temperature	-65 to 150	°C
T <sub>j</sub>	Max. Operating Junction Temperature	150	°C

For PNP type voltage and current values are negative.

# MJD112/MJD117

## THERMAL DATA

R <sub>thj-case</sub>	Thermal Resistance Junction-case	Max	6.25	°C/W
R <sub>thj-amb</sub>	Thermal Resistance Junction-ambient	Max	100	°C/W

## ELECTRICAL CHARACTERISTICS (T<sub>case</sub> = 25 °C unless otherwise specified)

Symbol	Parameter	Test Conditions	Min.	Typ.	Max.	Unit
I <sub>CB0</sub>	Collector Cut-off Current (I <sub>E</sub> = 0)	V <sub>CB</sub> = 100 V V <sub>CB</sub> = 80 V			0.02 0.01	mA mA
I <sub>CEO</sub>	Collector Cut-off Current (I <sub>B</sub> = 0)	V <sub>CE</sub> = 50 V			0.02	mA
I <sub>CEX</sub>	Collector Cut-off Current	V <sub>CB</sub> = 80 V V <sub>BE</sub> = -1.5V V <sub>CB</sub> = 80 V V <sub>BE</sub> = -1.5V T <sub>C</sub> = 125 °C			0.01 0.5	mA mA
I <sub>EBO</sub>	Emitter Cut-off Current (I <sub>C</sub> = 0)	V <sub>EB</sub> = 5 V			2	mA
V <sub>CEO(sus)</sub>	Collector-Emitter Sustaining Voltage	I <sub>C</sub> = 30 mA	100			V
V <sub>CE(sat)*</sub>	Collector-Emitter Saturation Voltage	I <sub>C</sub> = 2 A I <sub>B</sub> = 8 mA I <sub>C</sub> = 4 A I <sub>B</sub> = 40 mA			2 3	V V
V <sub>BE(sat)*</sub>	Collector-Base Saturation Voltage	I <sub>C</sub> = 4 A I <sub>B</sub> = 40 mA			4	V
V <sub>BE(on)*</sub>	Base-Emitter Voltage	I <sub>C</sub> = 2 A V <sub>CE</sub> = 3 V			2.8	V
h <sub>FE*</sub>	DC Current Gain	I <sub>C</sub> = 0.5 A V <sub>CE</sub> = 3 V I <sub>C</sub> = 2 A V <sub>CE</sub> = 3 V I <sub>C</sub> = 4 A V <sub>CE</sub> = 3 V	500 1000 200		12000	

\* Pulsed: Pulse duration = 300 μs, duty cycle ≤ 2 %

### Safe Operating Areas

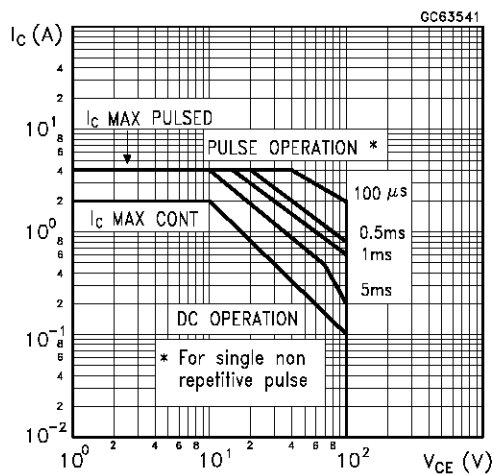

### Derating Curve

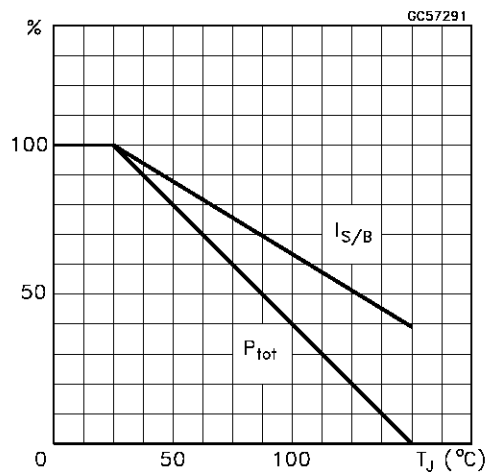

DC Current Gain (NPN type)

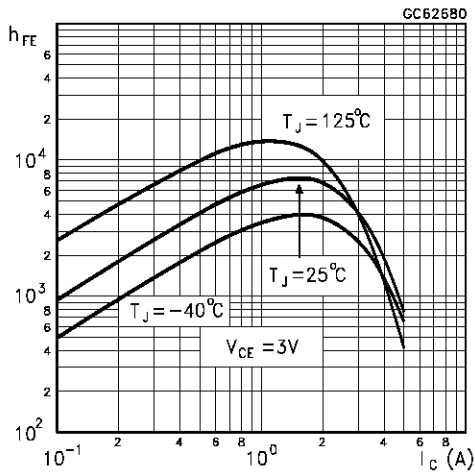

DC Current Gain (NPN type)

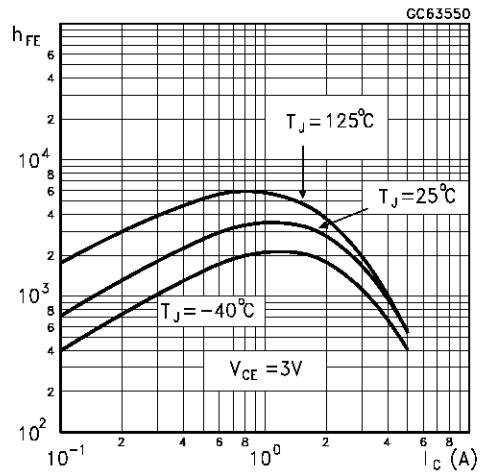

Collector-Emitter Saturation Voltage (NPN type)

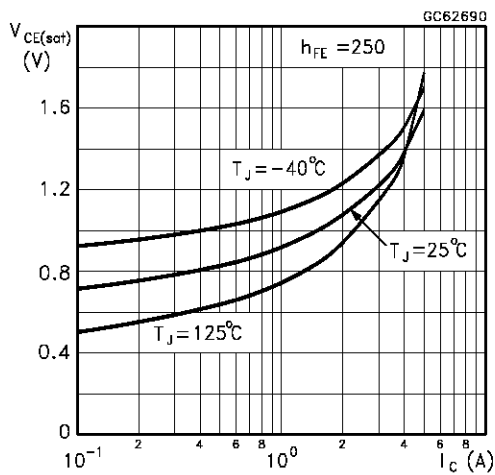

Collector-Emitter Saturation Voltage (PNP type)

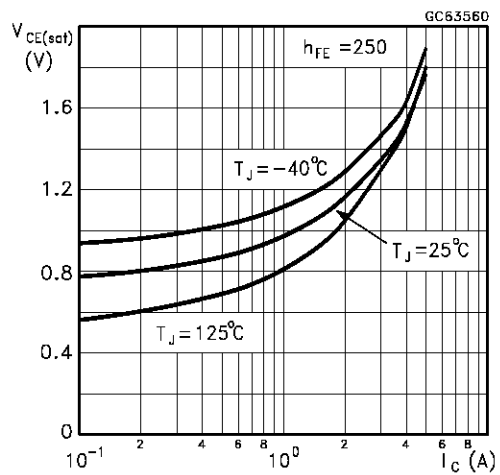

Base-Emitter Saturation Voltage (NPN type)

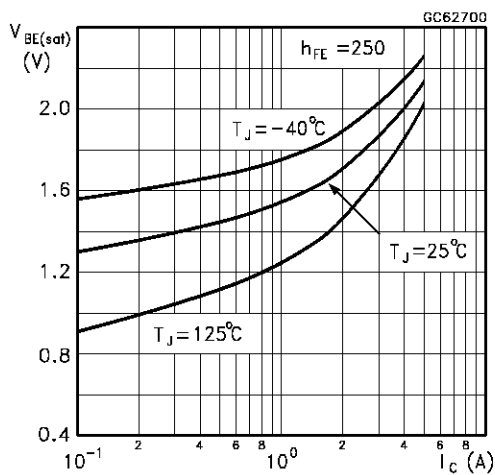

Base-Emitter Saturation Voltage (PNP type)

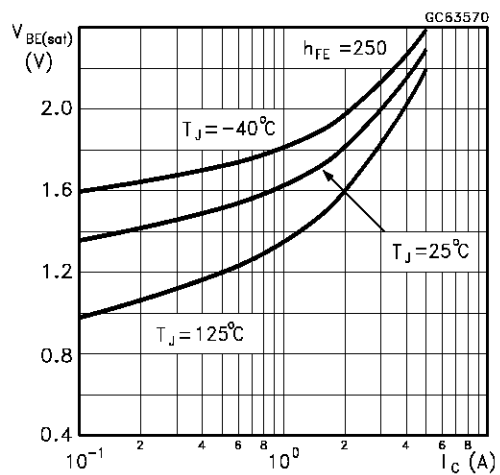

Base-Emitter On Voltage (NPN type)

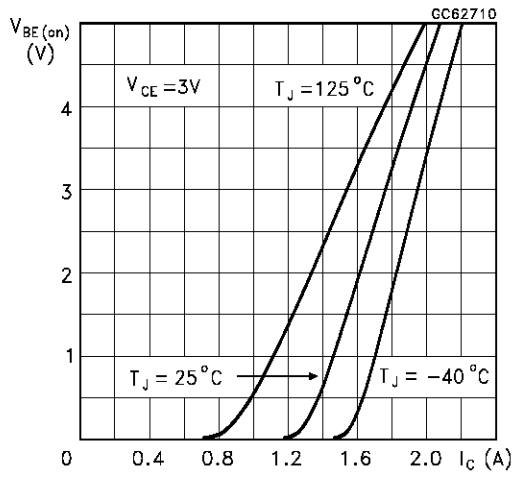

Base-Emitter On Voltage (PNP type)

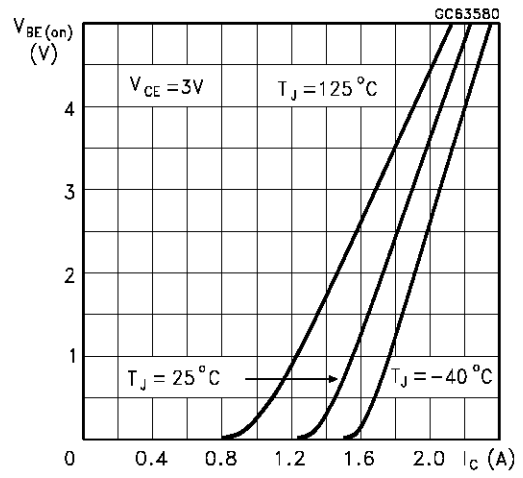

Freewheel Diode Forward Voltage (NPN types)

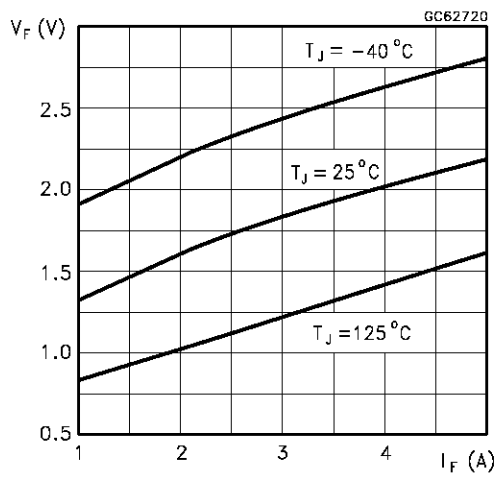

Freewheel Diode Forward Voltage (PNP types)

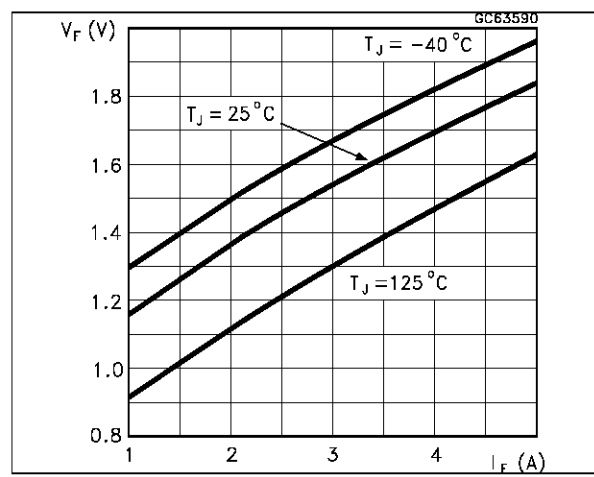

**TO-252 (DPAK) MECHANICAL DATA**

DIM.	mm			inch		
	MIN.	TYP.	MAX.	MIN.	TYP.	MAX.
A	2.2		2.4	0.086		0.094
A1	0.9		1.1	0.035		0.043
A2	0.03		0.23	0.001		0.009
B	0.64		0.9	0.025		0.035
B2	5.2		5.4	0.204		0.212
C	0.45		0.6	0.017		0.023
C2	0.48		0.6	0.019		0.023
D	6		6.2	0.236		0.244
E	6.4		6.6	0.252		0.260
G	4.4		4.6	0.173		0.181
H	9.35		10.1	0.368		0.397
L2		0.8			0.031	
L4	0.6		1	0.023		0.039

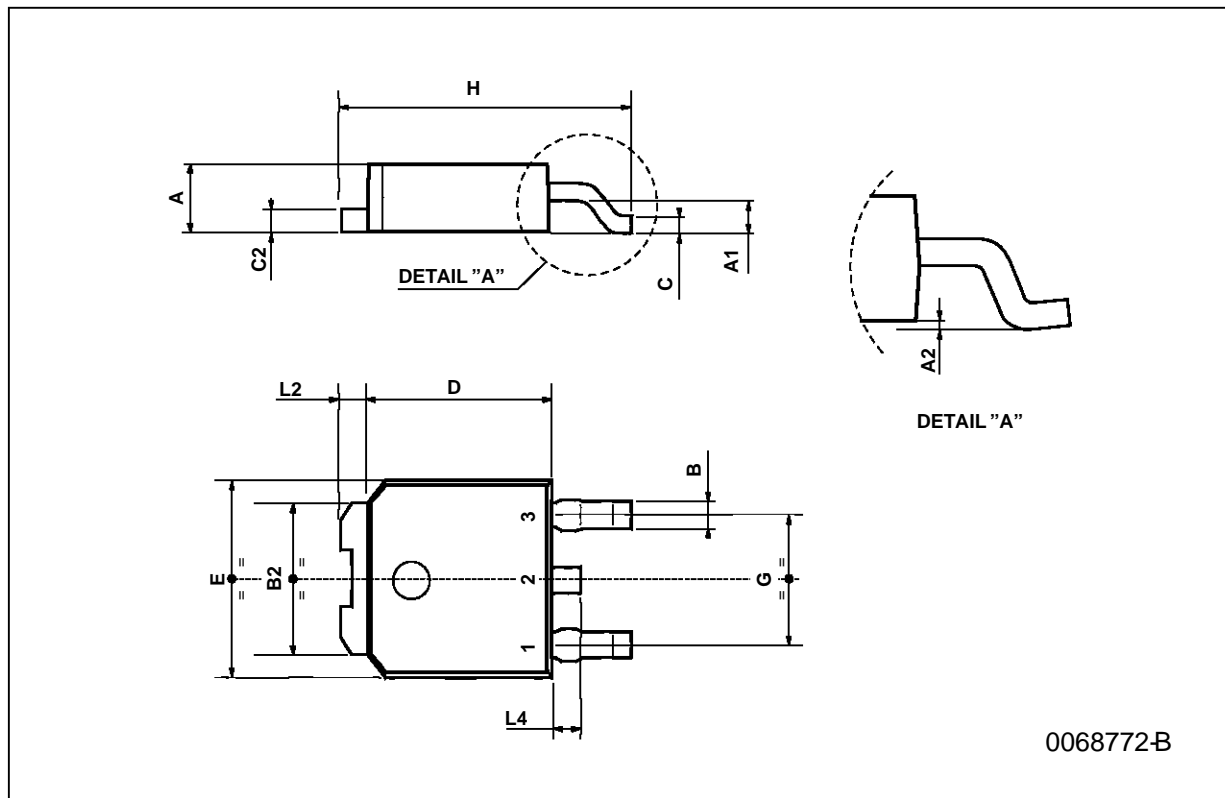

Information furnished is believed to be accurate and reliable. However, SGS-THOMSON Microelectronics assumes no responsibility for the consequences of use of such information nor for any infringement of patents or other rights of third parties which may result from its use. No license is granted by implication or otherwise under any patent or patent rights of SGS-THOMSON Microelectronics. Specifications mentioned in this publication are subject to change without notice. This publication supersedes and replaces all information previously supplied. SGS-THOMSON Microelectronics products are not authorized for use as critical components in life support devices or systems without express written approval of SGS-THOMSON Microelectronics.

© 1997 SGS-THOMSON Microelectronics - Printed in Italy - All Rights Reserved

SGS-THOMSON Microelectronics GROUP OF COMPANIES  
Australia - Brazil - Canada - China - France - Germany - Hong Kong - Italy - Japan - Korea - Malaysia - Malta - Morocco - The Netherlands -  
Singapore - Spain - Sweden - Switzerland - Taiwan - Thailand - United Kingdom - U.S.A  
...