

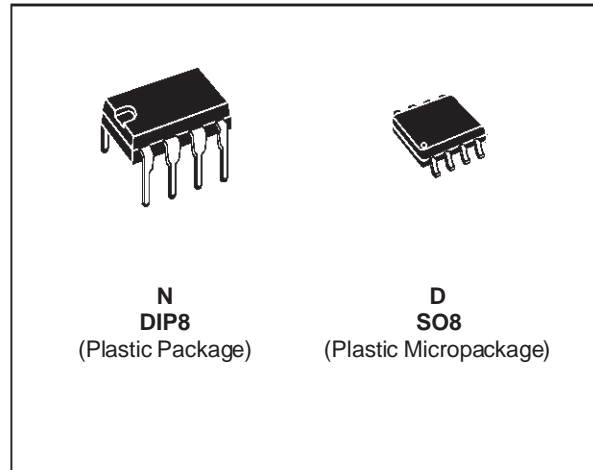

# LF153 LF253 - LF353

## WIDE BANDWIDTH DUAL J-FET OPERATIONAL AMPLIFIERS

- LOW POWER CONSUMPTION
- WIDE COMMON-MODE (UP TO  $V_{CC}^+$ ) AND DIFFERENTIAL VOLTAGE RANGE
- LOW INPUT BIAS AND OFFSET CURRENT
- OUTPUT SHORT-CIRCUIT PROTECTION
- HIGH INPUT IMPEDANCE J-FET INPUT STAGE
- INTERNAL FREQUENCY COMPENSATION
- LATCH UP FREE OPERATION
- HIGH SLEW RATE :  $16V/\mu s$  (typ)



### DESCRIPTION

The LF353 are high speed J-FET input dual operational amplifiers incorporating well matched, high voltage J-FET and bipolar transistors in a monolithic integrated circuit.

The devices feature high slew rates, low input bias and offset currents, and low offset voltage temperature coefficient.

### ORDER CODES

Part Number	Temperature	Package	
		N	D
LF353	0°C, +70°C	•	•
LF253	-40°C, +105°C	•	•
LF153	-55°C, +125°C	•	•

### PIN CONNECTIONS (top view)

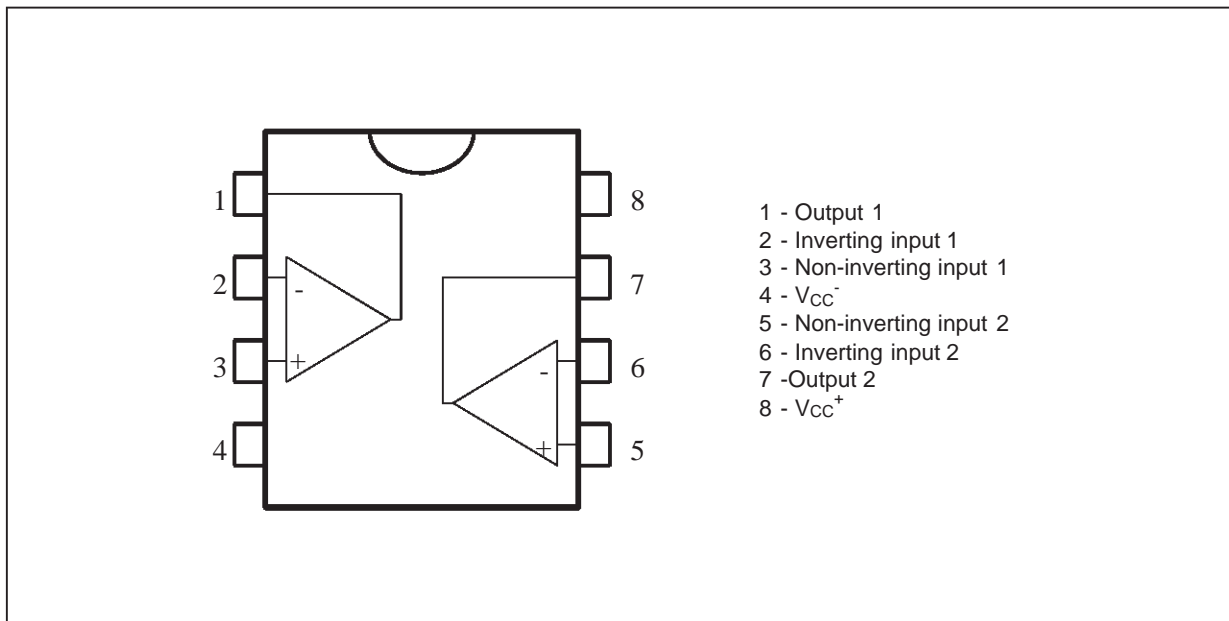

**SCHEMATIC DIAGRAM** (each amplifier)

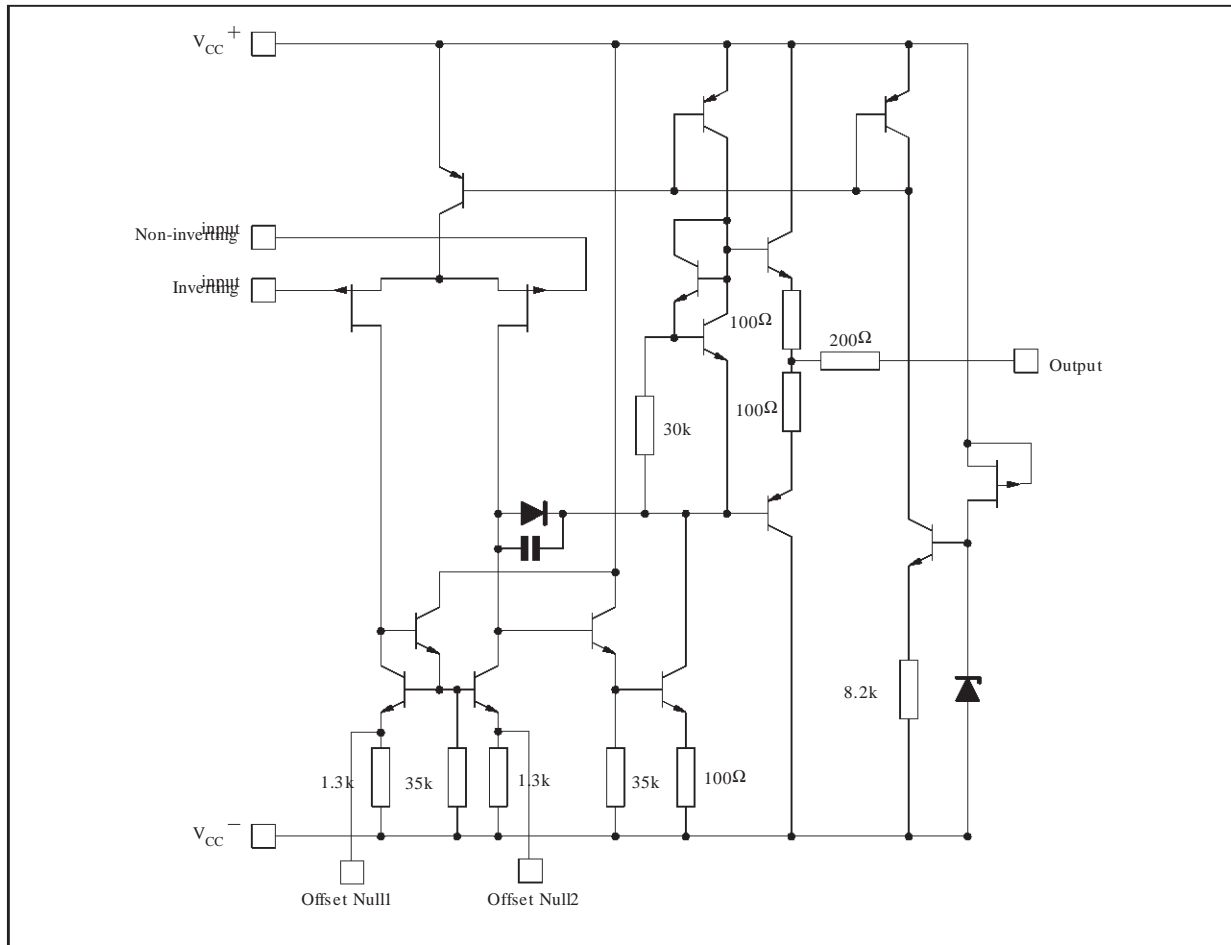

**ABSOLUTE MAXIMUM RATINGS**

Symbol	Parameter	Value	Unit
$V_{CC}$	Supply Voltage - (note 1)	$\pm 18$	V
$V_i$	Input Voltage - (note 3)	$\pm 15$	V
$V_{id}$	Differential Input Voltage - (note 2)	$\pm 30$	V
$P_{tot}$	Power Dissipation	680	mW
	Output Short-circuit Duration - (note 4)	Infinite	
$T_{oper}$	Operating Free Air Temperature Range	LF353 LF253 LF153	$^{\circ}C$
$T_{stg}$	Storage Temperature Range	-65 to 150	$^{\circ}C$

- Notes :**
1. All voltage values, except differential voltage, are with respect to the zero reference level (ground) of the supply voltages where the zero reference level is the midpoint between  $V_{CC}^+$  and  $V_{CC}^-$ .
  2. Differential voltages are at the non-inverting input terminal with respect to the inverting input terminal.
  3. The magnitude of the input voltage must never exceed the magnitude of the supply voltage or 15 volts, whichever is less.
  4. The output may be shorted to ground or to either supply. Temperature and /or supply voltages must be limited to ensure that the dissipation rating is not exceeded.

**ELECTRICAL CHARACTERISTICS**

V<sub>CC</sub> = ±15V, T<sub>amb</sub> = 25°C (unless otherwise specified)

Symbol	Parameter	LF153 - LF253 - LF353			Unit
		Min.	Typ.	Max.	
V <sub>io</sub>	Input Offset Voltage (R <sub>S</sub> = 10kΩ) T <sub>amb</sub> = 25°C T <sub>min.</sub> ≤ T <sub>amb</sub> ≤ T <sub>max.</sub>		3	10 13	mV
DV <sub>io</sub>	Input Offset Voltage Drift		10		μV/°C
I <sub>io</sub>	Input Offset Current * T <sub>amb</sub> = 25°C T <sub>min.</sub> ≤ T <sub>amb</sub> ≤ T <sub>max.</sub>		5	100 4	pA nA
I <sub>ib</sub>	Input Bias Current * T <sub>amb</sub> = 25°C T <sub>min.</sub> ≤ T <sub>amb</sub> ≤ T <sub>max.</sub>		20	200 20	pA nA
A <sub>vd</sub>	Large Signal Voltage Gain (R <sub>L</sub> = 2kΩ, V <sub>O</sub> = ±10V) T <sub>amb</sub> = 25°C T <sub>min.</sub> ≤ T <sub>amb</sub> ≤ T <sub>max.</sub>	50 25	200		V/mV
SVR	Supply Voltage Rejection Ratio (R <sub>S</sub> = 10kΩ) T <sub>amb</sub> = 25°C T <sub>min.</sub> ≤ T <sub>amb</sub> ≤ T <sub>max.</sub>	80 80	86		dB
I <sub>CC</sub>	Supply Current (no load) T <sub>amb</sub> = 25°C T <sub>min.</sub> ≤ T <sub>amb</sub> ≤ T <sub>max.</sub>		1.4	3.2 3.2	mA
V <sub>icm</sub>	Input Common Mode Voltage Range	±11	+15 -12		V
CMR	Common Mode Rejection Ratio (R <sub>S</sub> = 10kΩ) T <sub>amb</sub> = 25°C T <sub>min.</sub> ≤ T <sub>amb</sub> ≤ T <sub>max.</sub>	70 70	86		dB
I <sub>OS</sub>	Output Short-circuit Current T <sub>amb</sub> = 25°C T <sub>min.</sub> ≤ T <sub>amb</sub> ≤ T <sub>max.</sub>	10 10	40	60 60	mA
±V <sub>OPP</sub>	Output Voltage Swing T <sub>amb</sub> = 25°C T <sub>min.</sub> ≤ T <sub>amb</sub> ≤ T <sub>max.</sub>				V
				R <sub>L</sub> = 2kΩ R <sub>L</sub> = 10kΩ R <sub>L</sub> = 2kΩ R <sub>L</sub> = 10kΩ	
SR	Slew Rate (V <sub>i</sub> = 10V, R <sub>L</sub> = 2kΩ, C <sub>L</sub> = 100pF, T <sub>amb</sub> = 25°C, unity gain)	12	16		V/μs
t <sub>r</sub>	Rise Time (V <sub>i</sub> = 20mV, R <sub>L</sub> = 2kΩ, C <sub>L</sub> = 100pF, T <sub>amb</sub> = 25°C, unity gain)		0.1		μs
K <sub>OV</sub>	Overshoot (V <sub>i</sub> = 20mV, R <sub>L</sub> = 2kΩ, C <sub>L</sub> = 100pF, T <sub>amb</sub> = 25°C, unity gain)		10		%
GBP	Gain Bandwidth Product (f = 100kHz, T <sub>amb</sub> = 25°C, V <sub>in</sub> = 10mV, R <sub>L</sub> = 2kΩ, C <sub>L</sub> = 100pF)	2.5	4		MHz
R <sub>i</sub>	Input Resistance		10 <sup>12</sup>		Ω
THD	Total Harmonic Distortion (f = 1kHz, A <sub>V</sub> = 20dB, R <sub>L</sub> = 2kΩ, C <sub>L</sub> = 100pF, T <sub>amb</sub> = 25°C, V <sub>O</sub> = 2V <sub>PP</sub> )		0.01		%
e <sub>n</sub>	Equivalent Input Noise Voltage (f = 1kHz, R <sub>S</sub> = 100Ω)		15		$\frac{nV}{\sqrt{Hz}}$
∅ <sub>m</sub>	Phase Margin		45		Degrees
V <sub>O1</sub> /V <sub>O2</sub>	Channel Separation (A <sub>V</sub> = 100, T <sub>amb</sub> = 25°C)		120		dB

\* The input bias currents are junction leakage currents which approximately double for every 10°C increase in the junction temperature.

**MAXIMUM PEAK-TO-PEAK OUTPUT VOLTAGE VERSUS FREQUENCY**

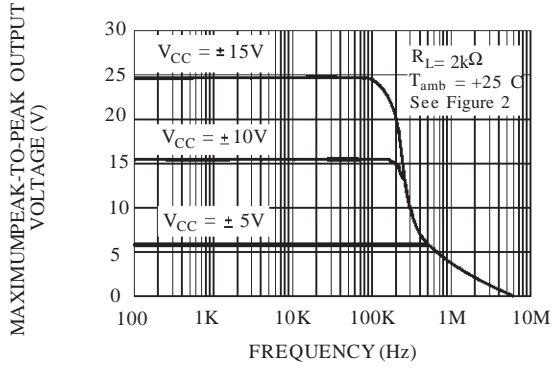

**MAXIMUM PEAK-TO-PEAK OUTPUT VOLTAGE VERSUS FREQUENCY**

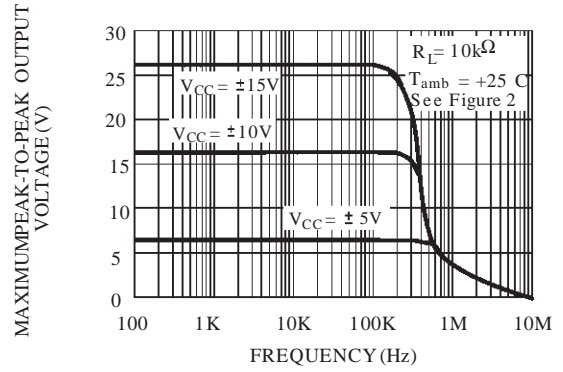

**MAXIMUM PEAK-TO-PEAK OUTPUT VOLTAGE VERSUS FREQUENCY**

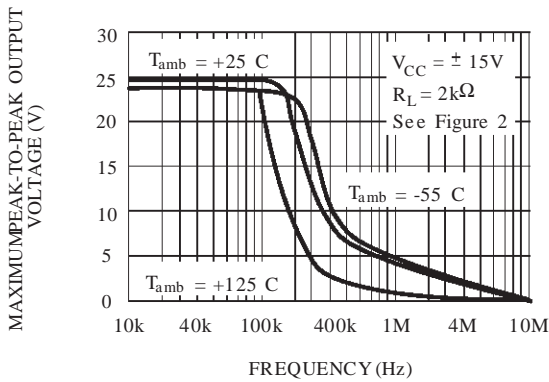

**MAXIMUM PEAK-TO-PEAK OUTPUT VOLTAGE VERSUS FREE AIR TEMP.**

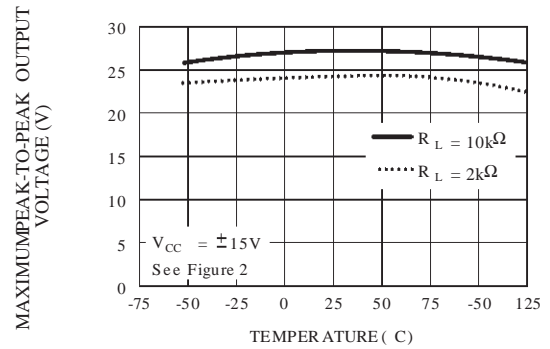

**MAXIMUM PEAK-TO-PEAK OUTPUT VOLTAGE VERSUS LOAD RESISTANCE**

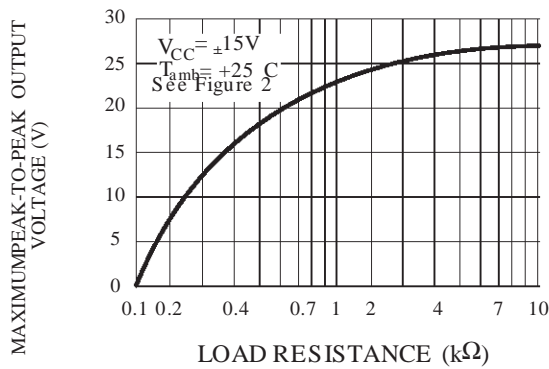

**MAXIMUM PEAK-TO-PEAK OUTPUT VOLTAGE VERSUS SUPPLY VOLTAGE**

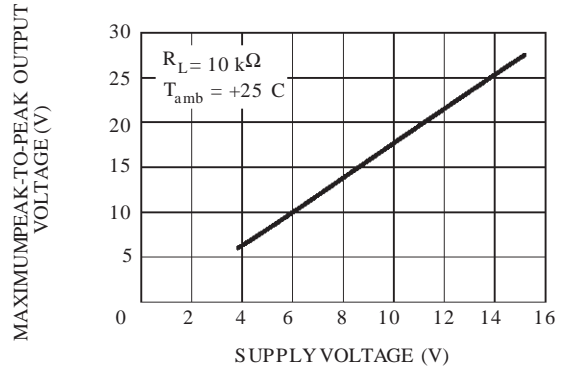

**INPUT BIAS CURRENT VERSUS FREE AIR TEMPERATURE**

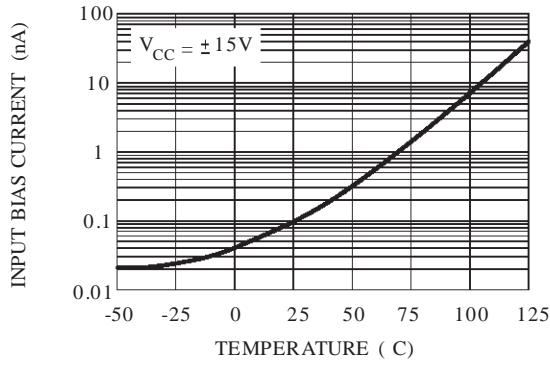

**LARGE SIGNAL DIFFERENTIAL VOLTAGE AMPLIFICATION VERSUS FREE AIR TEMPERATURE**

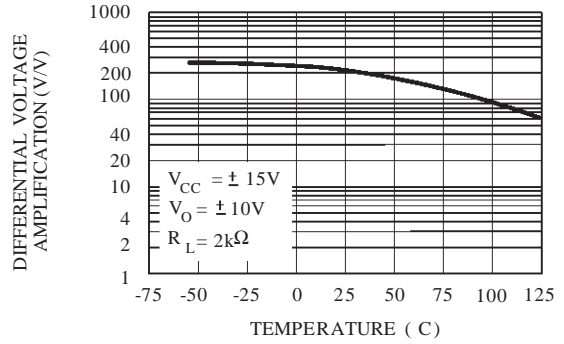

**LARGE SIGNAL DIFFERENTIAL VOLTAGE AMPLIFICATION AND PHASE SHIFT VERSUS FREQUENCY**

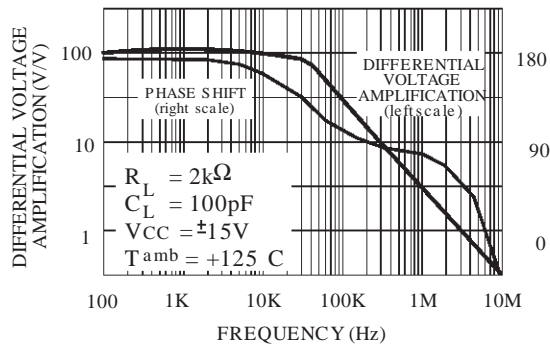

**TOTAL POWER DISSIPATION VERSUS FREE AIR TEMPERATURE**

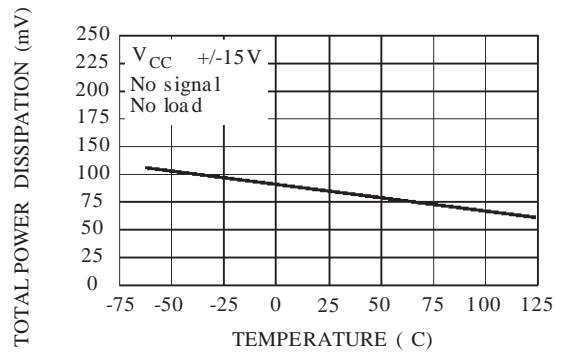

**SUPPLY CURRENT PER AMPLIFIER VERSUS FREE AIR TEMPERATURE**

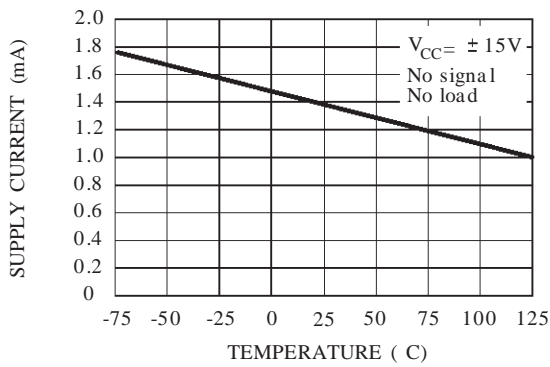

**SUPPLY CURRENT PER AMPLIFIER VERSUS SUPPLY VOLTAGE**

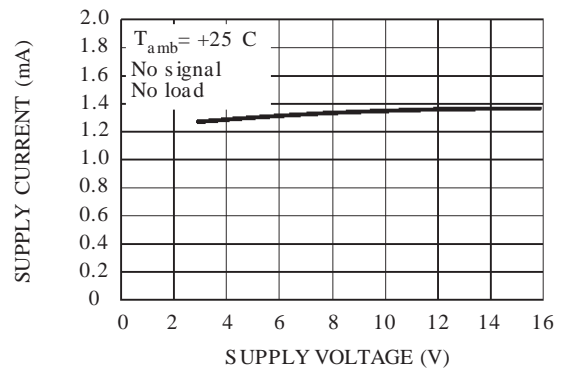

**COMMON MODE REJECTION RATIO  
VERSUS FREE AIR TEMPERATURE**

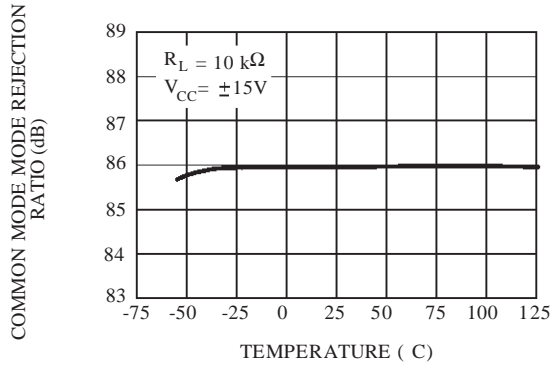

**VOLTAGE FOLLOWER LARGE SIGNAL  
PULSE RESPONSE**

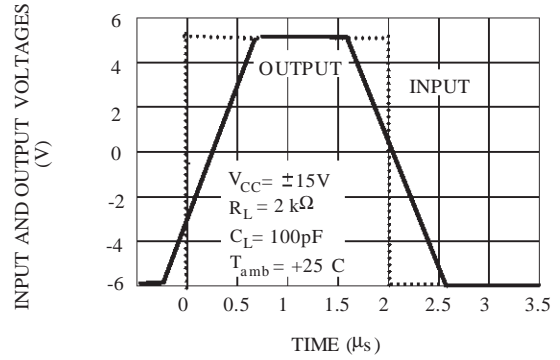

**OUTPUT VOLTAGE VERSUS  
ELAPSED TIME**

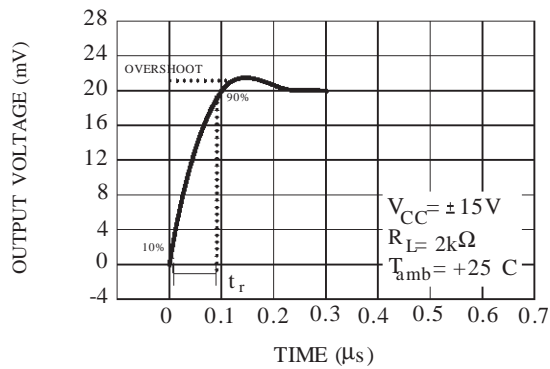

**EQUIVALENT INPUT NOISE VOLTAGE  
VERSUS FREQUENCY**

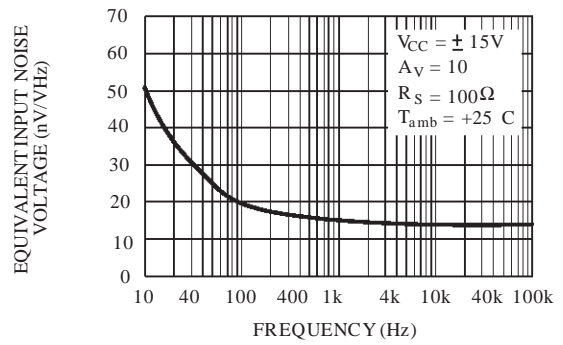

**TOTAL HARMONIC DISTORTION VERSUS  
FREQUENCY**

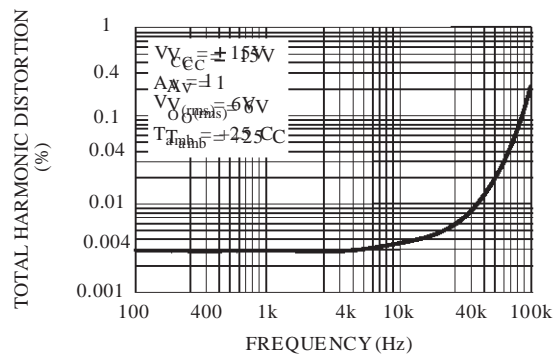

PARAMETER MEASUREMENT INFORMATION

Figure 1 : Voltage Follower

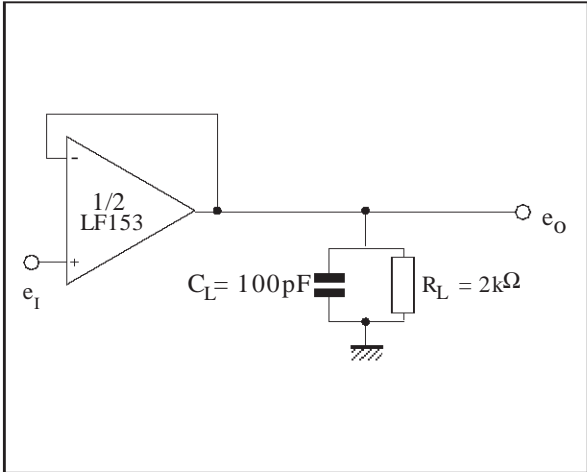
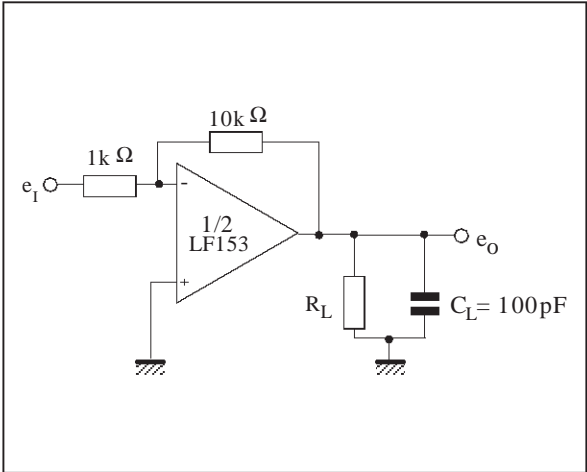
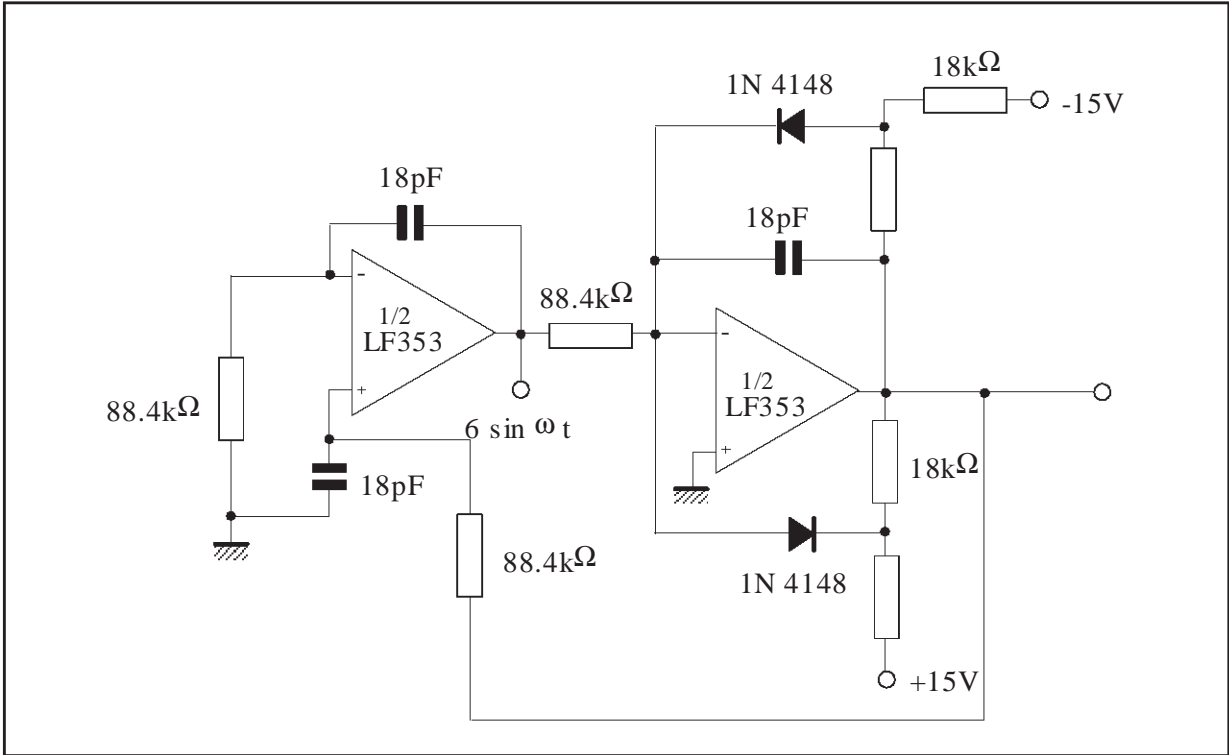

Figure 2 : Gain-of-10 Inverting Amplifier



TYPICAL APPLICATIONS

QUADRUPLE OSCILLATOR



LF153 - LF253 - LF353

PACKAGE MECHANICAL DATA  
8 PINS - PLASTIC DIP



PM-DIP8.EPS

Dimensions	Millimeters			Inches		
	Min.	Typ.	Max.	Min.	Typ.	Max.
A		3.32			0.131	
a1	0.51			0.020		
B	1.15		1.65	0.045		0.065
b	0.356		0.55	0.014		0.022
b1	0.204		0.304	0.008		0.012
D			10.92			0.430
E	7.95		9.75	0.313		0.384
e		2.54			0.100	
e3		7.62			0.300	
e4		7.62			0.300	
F			6.6			0.260
i			5.08			0.200
L	3.18		3.81	0.125		0.150
Z			1.52			0.060

DIP8.TBL



**PACKAGE MECHANICAL DATA**  
8 PINS - PLASTIC MICROPACKAGE (SO)

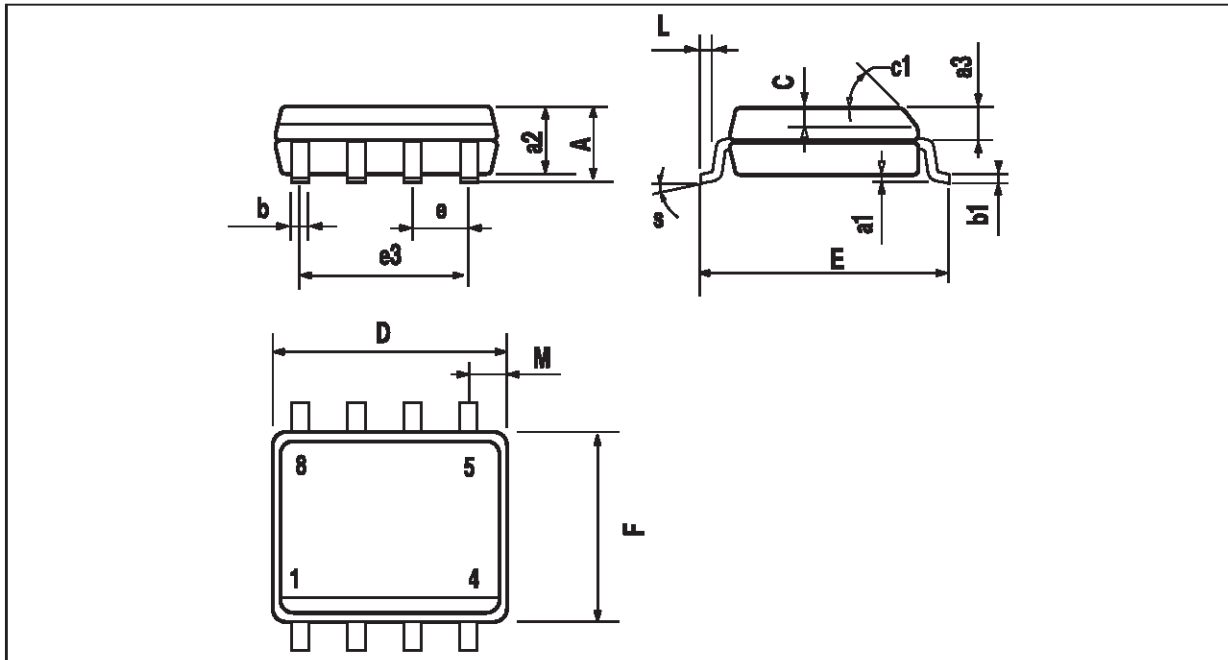

PM-S08.EPS

Dimensions	Millimeters			Inches		
	Min.	Typ.	Max.	Min.	Typ.	Max.
A			1.75			0.069
a1	0.1		0.25	0.004		0.010
a2			1.65			0.065
a3	0.65		0.85	0.026		0.033
b	0.35		0.48	0.014		0.019
b1	0.19		0.25	0.007		0.010
C	0.25		0.5	0.010		0.020
c1	45° (typ.)					
D	4.8		5.0	0.189		0.197
E	5.8		6.2	0.228		0.244
e		1.27			0.050	
e3		3.81			0.150	
F	3.8		4.0	0.150		0.157
L	0.4		1.27	0.016		0.050
M			0.6			0.024
S	8° (max.)					

S08.TBL

Information furnished is believed to be accurate and reliable. However, STMicroelectronics assumes no responsibility for the consequences of use of such information nor for any infringement of patents or other rights of third parties which may result from its use. No license is granted by implication or otherwise under any patent or patent rights of STMicroelectronics. Specifications mentioned in this publication are subject to change without notice. This publication supersedes and replaces all information previously supplied. STMicroelectronics products are not authorized for use as critical components in life support devices or systems without express written approval of STMicroelectronics.

© The ST logo is a trademark of STMicroelectronics

© 1998 STMicroelectronics – Printed in Italy – All Rights Reserved  
STMicroelectronics GROUP OF COMPANIES

Australia - Brazil - Canada - China - France - Germany - Italy - Japan - Korea - Malaysia - Malta - Mexico - Morocco  
The Netherlands - Singapore - Spain - Sweden - Switzerland - Taiwan - Thailand - United Kingdom - U.S.A.

ORDER CODE :

