



# SM6HTxxA

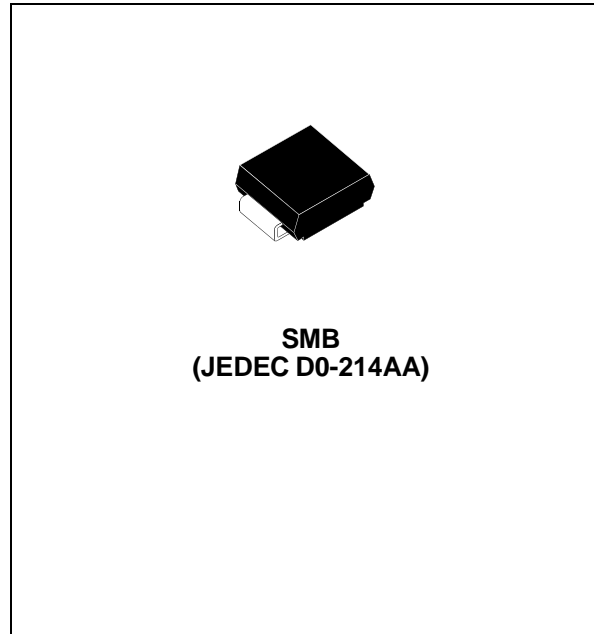
## HIGH TEMPERATURE TRANSIL™ FOR AUTOMOTIVE APPLICATIONS

### FEATURES

- HIGH PERFORMANCE TRANSIL DESIGNED TO FIT HIGH TEMPERATURE ENVIRONMENT LIKE AUTOMOTIVE APPLICATIONS...
- HIGH RELIABILITY PLANAR TECHNOLOGY
- HIGH PERFORMANCE IN VOLTAGE REGULATION MODE
- VERY LOW LEAKAGE CURRENT  
( $I_R \text{ max} = 5\mu\text{A} @ T_{\text{amb}} = 150^\circ\text{C}$ )
- PEAK PULSE POWER : 600 W (10/1000 $\mu\text{s}$ )
- FAST RESPONSE TIME
- UNIDIRECTIONAL TYPE
- LOW CLAMPING FACTOR

### DESCRIPTION

This high performance Transil series has been designed to fit high temperature environment such as automotive applications, using surface mount technology. These devices are using high reliability planar technology resulting in high performances in voltage regulation mode and low leakage current at high temperature.



### ABSOLUTE MAXIMUM RATINGS ( $T_{\text{amb}} = 25^\circ\text{C}$ )

Symbol	Parameter		Value	Unit
PPP	Peak pulse power dissipation (see note 1)	$T_j \text{ initial} = T_{\text{amb}}$	600	W
P	Power dissipation on infinite heatsink	$T_{\text{amb}} = 50^\circ\text{C}$	5	W
$I_{\text{FSM}}$	Non repetitive surge peak forward current for unidirectional types	$t_p = 10\text{ms}$ $T_j \text{ initial} = T_{\text{amb}}$	75	A
$T_{\text{stg}}, T_J$	Storage and operating junction temperature range		- 65 to 175	$^\circ\text{C}$
$T_L$	Maximum lead temperature for soldering during 10 s.		260	$^\circ\text{C}$

**Note 1** : For a surge greater than the maximum values, the diode will fail in short-circuit.

### THERMAL RESISTANCES

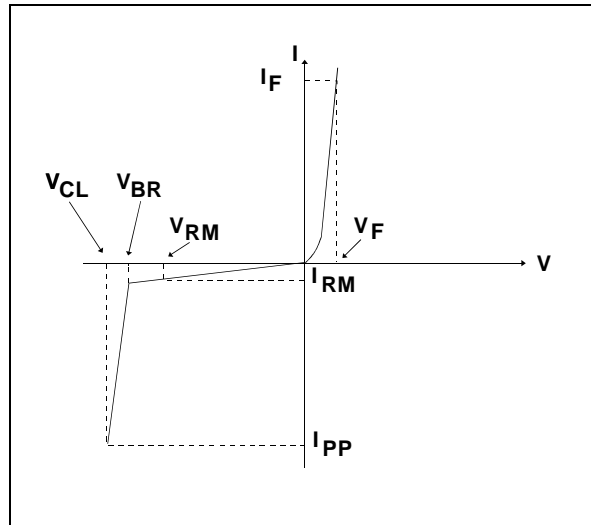
Symbol	Parameter	Value	Unit
$R_{\text{th (j-l)}}$	Junction to leads	20	$^\circ\text{C/W}$
$R_{\text{th (j-a)}}$	Junction to ambient on printed circuit. On recommended pad layout	100	$^\circ\text{C/W}$

## SM6HTxxA

### ELECTRICAL CHARACTERISTICS

( $T_{amb} = 25^{\circ}\text{C}$  unless otherwise specified)

Symbol	Parameter
$V_{RM}$	Stand-off voltage
$V_{BR}$	Breakdown voltage
$V_{CL}$	Clamping voltage
$I_{RM}$	Leakage current @ $V_{RM}$
$I_{PP}$	Peak pulse current
$V_F$	Forward voltage drop $V_F < 3.5\text{V}$ @ $I_F = 50\text{A}$ (pulse test: $t_p \leq 500\mu\text{s}$ )

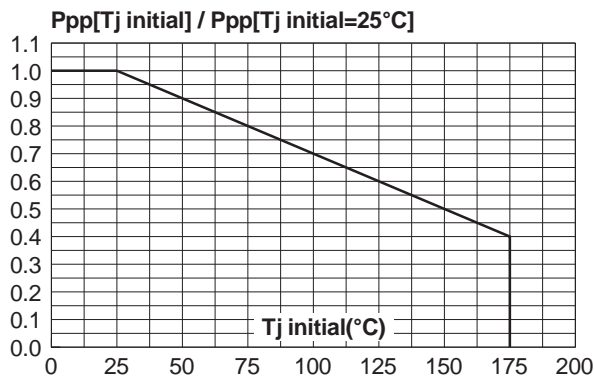


Types	Marking	$I_{RM}$ @ $V_{RM}$			$V_{BR}$ @ $I_R$			$V_{CL}$ @ $I_{PP}$ 10/1000 $\mu\text{s}$ max	$\alpha T$ max note 3 10 <sup>-4</sup> /°C		
		$T_{amb}=25^{\circ}\text{C}$ max	$T_{amb}=150^{\circ}\text{C}$ max		note2						
		$\mu\text{A}$	$\mu\text{A}$	V	min	nom	max			mA	
SM6HT24A	EMB	2	5	20.5	22.8	24	25.2	1	33.2	18.0	9.4
SM6HT27A	EPB	2	5	23.1	25.7	27	28.4	1	37.5	16.0	9.6
SM6HT30A	ERB	2	5	25.6	28.5	30	31.5	1	41.5	14.5	9.7
SM6HT36A	EVB	2	5	30.8	34.2	36	37.8	1	49.9	12.0	9.9
SM6HT39A	EXB	2	5	33.3	37.1	39	41.0	1	53.9	11.1	10.0
SM6HT43A	EYB	2	5	36.8	40.9	43	45.2	1	59.3	10.1	10.1

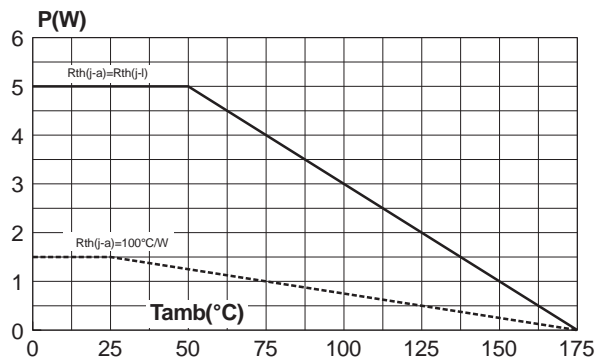
Note 2 : Pulse test :  $t_p < 50$  ms

Note 3 :  $\Delta V_{BR} = \alpha T \times (T_{amb} - 25) \times V_{BR} (25^{\circ}\text{C})$

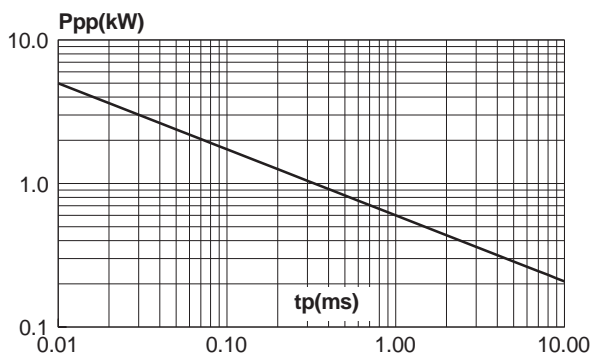
**Fig. 1-1:** Peak power dissipation versus initial junction temperature.



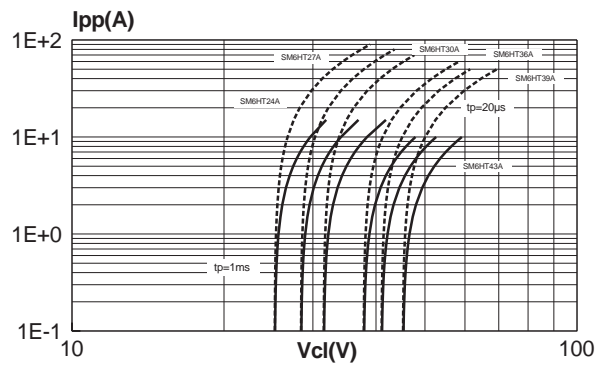
**Fig. 1-2:** Continuous power dissipation versus ambient temperature.



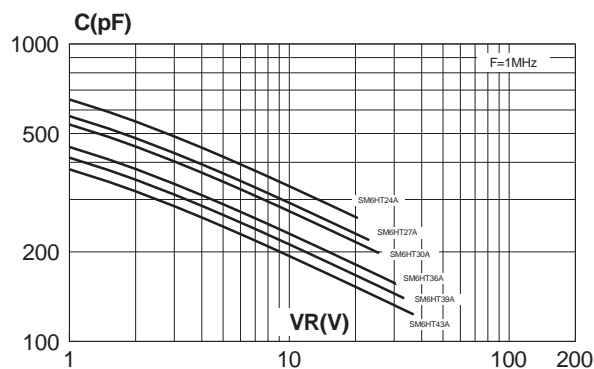
**Fig. 2:** Peak pulse power versus exponential pulse duration ( $T_j \text{ initial}=25^\circ\text{C}$ ).



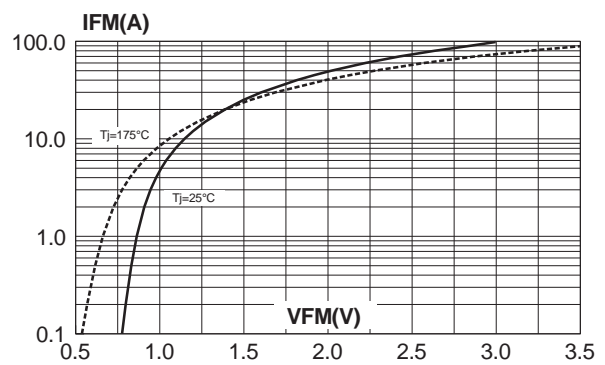
**Fig. 3:** Clamping voltage versus peak pulse current ( $T_j \text{ initial}=25^\circ\text{C}$ ).



**Fig. 4:** Junction capacitance versus reverse applied voltage (typical values).

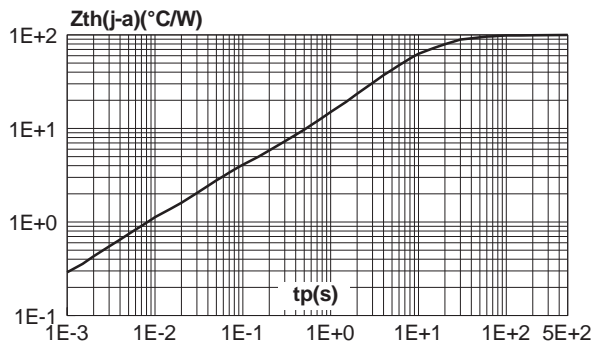


**Fig. 5:** Peak forward voltage drop versus peak forward current (typical values).

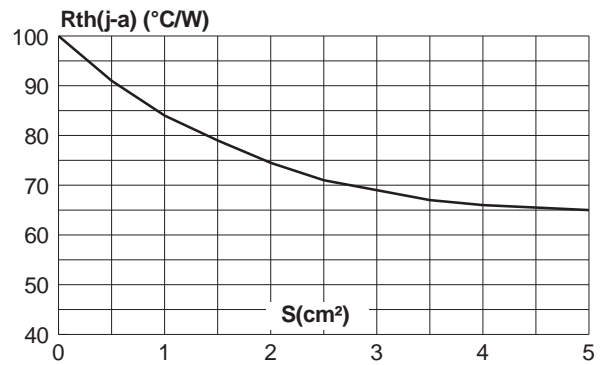


## SM6HTxxA

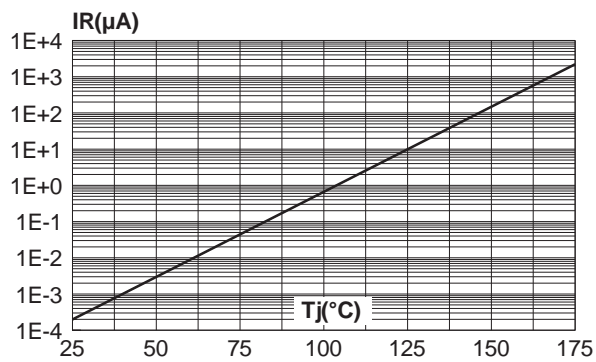
**Fig. 6:** Variation of thermal impedance junction to ambient versus pulse duration (Printed circuit board FR4 with recommended pad layout).



**Fig. 7:** Thermal resistance junction to ambient versus copper surface under each lead (printed circuit board FR4,  $e(Cu)=35\mu m$ ).



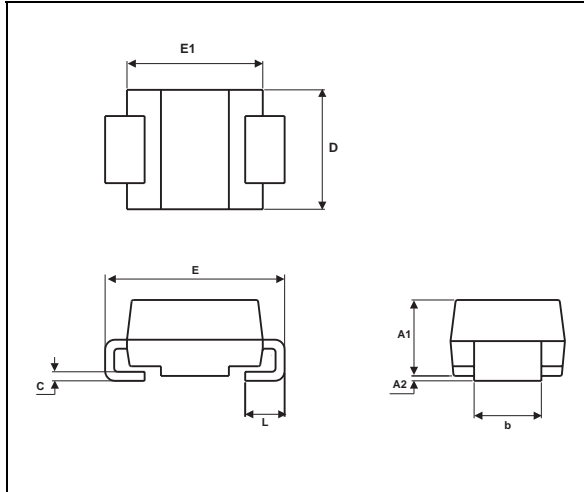
**Fig. 8:** Variation of leakage current versus junction temperature (typical values).



**MARKING** : Logo, Date Code, Type Code, Cathode Band.

**PACKAGE MECHANICAL DATA**

SMB (Plastic)

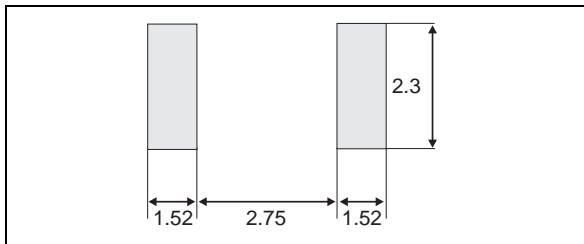


REF.	DIMENSIONS			
	Millimeters		Inches	
	Min.	Max.	Min.	Max.
A1	1.90	2.45	0.075	0.096
A2	0.05	0.20	0.002	0.008
b	1.95	2.20	0.077	0.087
c	0.15	0.41	0.006	0.016
E	5.10	5.60	0.201	0.220
E1	4.05	4.60	0.159	0.181
D	3.30	3.95	0.130	0.156
L	0.75	1.60	0.030	0.063

**Weight** = 0.107 g

**FOOTPRINT DIMENSIONS (Millimeter)**

SMB Plastic.



**Packaging** : standard packaging is tape and reel.

Information furnished is believed to be accurate and reliable. However, STMicroelectronics assumes no responsibility for the consequences of use of such information nor for any infringement of patents or other rights of third parties which may result from its use. No license is granted by implication or otherwise under any patent or patent rights of STMicroelectronics. Specifications mentioned in this publication are subject to change without notice. This publication supersedes and replaces all information previously supplied. STMicroelectronics products are not authorized for use as critical components in life support devices or systems without express written approval of STMicroelectronics.

The ST logo is a registered trademark of STMicroelectronics

© 1999 STMicroelectronics - Printed in Italy - All rights reserved.

STMicroelectronics GROUP OF COMPANIES

Australia - Brazil - Canada - China - France - Germany - Italy - Japan - Korea - Malaysia - Malta - Mexico - Morocco - The Netherlands - Singapore - Spain - Sweden - Switzerland - Taiwan - Thailand - United Kingdom - U.S.A.

<http://www.st.com>